

SERVICE MANUAL FOR **SINGER** SWING-NEEDLE SEWING MACHINES

FOR COMBINED STRAIGHT AND ZIGZAG STITCHING
REVERSIBLE FEED

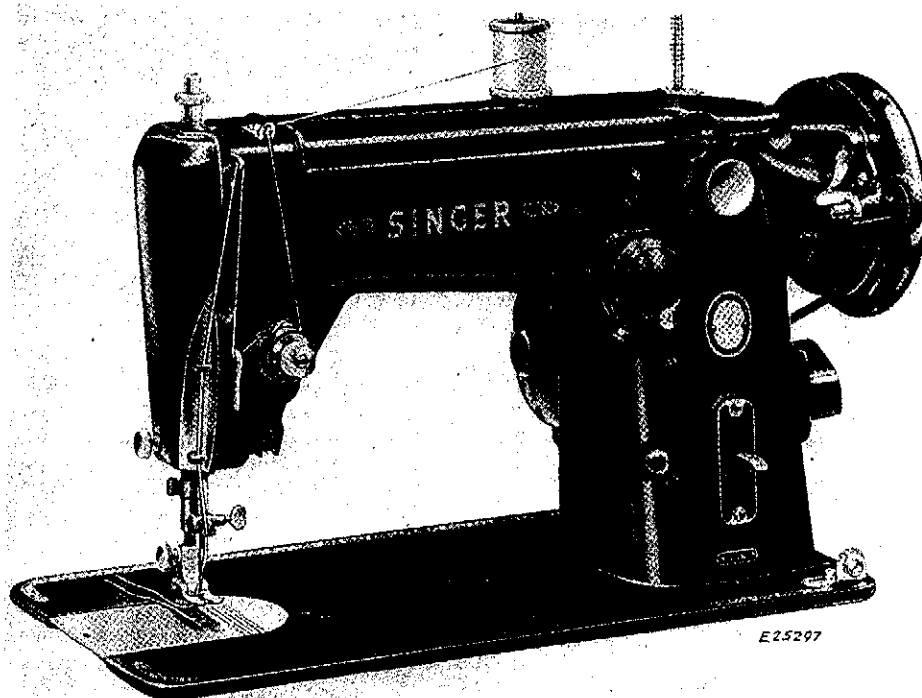

Machine 306w25

See Index on pages 169 to 174

THE SINGER MANUFACTURING COMPANY

*A Trademark of THE SINGER MANUFACTURING COMPANY

Insert in place of Corresponding Sheet in Form 20732 (257)

PROPERTY OF
THE SINGER MANUFACTURING COMPANY

This is a private and confidential communication to and for the use of only the employees of The Singer Manufacturing Company and its affiliated companies. Reproduction, sale, distribution, or publication thereof to the public is forbidden.

TABLE OF CONTENTS

	Page
SINGER Automatic Swing-Needle Sewing Machines	3 to 79
SINGER Non-Automatic Swing-Needle Sewing Machines of Class 306 and Machine 206K43	81 to 85
SINGER Non-Automatic Swing-Needle Sewing Machine 206K25	87 to 102
SINGER Automatic Swing-Needle Sewing Machines of Class 319	103 to 123
SINGER Automatic Swing-Needle Sewing Machines of Class 401	125 to 162
Descriptions of Machines	163 to 168
Index	169 to 174

SINGER AUTOMATIC SWING-NEEDLE MACHINES

The instructions on the following pages, up to and including page 79, apply to 306 Automatic Swing-Needle Machines.

TIPS ON SETTING UP

After removing the machine from its packing case, set it up in the order noted below.

1. **Inspect for concealed damage incurred during transit, typical forms of which are as follows:**

Bent arm shaft.

Broken or bent hand wheel.

Cracked or bent bed.

Noisy gears (high pitched whining gear tone as well as gear growl) caused by severe shock.

Machine bound tight by severe shock.

Broken or bent under-bed parts.

Broken or cracked motor end covers, light and pulley.

Broken or bent stitch regulator lever.

Water damage (observe for water marks inside carton).

2. Turn hand wheel over toward you to make certain that sewing mechanism turns freely.

3. Wipe off all traces of the tacky anti-rust oil used to protect the polished and plated surfaces. Give particular attention to the needle thread tension assembly.

4. Apply motor and light to machine and check operating behavior.

5. Remove bobbin case and wash in Varsol, making sure all traces of tacky oil have been washed out from under the tension spring.

6. **By means of an oil can filled with Varsol, flood the sewing hook assembly. Run machine for about three to five minutes until all the tacky oil is washed out. Then apply SINGER Oil and run-in the machine again for three to five minutes.**

7. Oil the sewing machine completely. See **pages 74 to 77. Wipe away all surplus oil.**

8. Make sure there is heat expansion clearance .015 to .020 inch between rear arm shaft bushing and flanged bushing. See **page 27.**

9. Inspect condition of needle before making sewing test. See **page 5.** Check hook and needle relationship.

10. Sew-in the machine and check the stitching for correct behavior of bight controls and pendulum motion. See **pages 52 to 55.**

11. Make sure stitch regulator moves freely; that it does not creep when sewing or that it sticks or binds.

12. Test wind a bobbin to be sure that bobbin winds evenly.

13. Check bobbin case tension with silk as described on **page 21.**

14. Polish the head to a satin finish. **Do not leave an oily or a greasy film on any portion of the head or the cabinet.**

ORDER OF INSPECTION OF CUSTOMER'S MACHINES AT THE BENCH

1. Obtain complete information concerning the customer's sewing problem before making any adjustments.
2. Obtain samples of the customer's material and thread for final testing.
3. Check threading of machine.
4. Inspect needle for—
 - a. Make. All SINGER needles are marked with the Company's trademark **SIMANCO** *.
 - b. Comparison of size with the thread used. See **page 10**.
 - c. Damage (Needle bent or blunt—needle eye rough.)
 - d. Relation to needle hole in throat plate. Check for straight sewing and for maximum zigzag stitching. See **pages 22** and **52**.
5. Check condition of needle hole (or slot) in presser foot and in throat plate.
6. Check thread clearance between position finger and bobbin case holder. See **page 42**.
7. Check relationship of needle with sewing hook. See **pages 9** and **41** to **44**.
8. Check pendulum motion of needle bar. See **pages 52** to **55**.
9. Inspect hook timing at central position of needle. See **page 43**.
10. Check needle bar height at extreme left needle position. See **page 44**.
11. Check feed mechanism for—
 - a. Timing of feed movement. See **page 29**.
 - b. Feed dog height. See **page 30**.
 - c. Position of feed dog in throat plate slots. See **page 32**.
 - d. Test feed for slight forward motion at "O".
12. Test bight controls, using needle perforation tests. See **pages 58** and **59**.
13. Check arm shaft connection belt for looseness.



SUGGESTIONS TO THE SERVICEMAN IN THE HOME

Quite frequently, when a machine is not sewing satisfactorily, the required adjustments can be accomplished in the home by a SINGER Serviceman.

Conditions such as faulty operation of the bight control or worn or damaged parts may have to be remedied at the SINGER Shop, but this decision should be made only after the machine is thoroughly checked in the exact order outlined below.

Use a **Checklist** similar to one shown on **page 7** as a record for the man at the bench.

ORDER OF INSPECTION IN THE HOME

1. Inspect recent samples of sewing made by the customer on the machine, before checking machine itself. Ask customer to indicate on sewing samples the particular stitching faults she has made reference to.
2. Check the combination of needle and thread used by customer. See **page 10**.
3. Check needle for—
 - a. wear or damage (needle blunt, bent or burred).
 - b. position in needle clamp. See **pages 12 and 88**.
 - c. location in:
 - throat plate
 - presser foot
 - relation to sewing hook point
 - d. damage from striking hook point
4. Check threading of machine, both upper and under threads.
5. Check tensions of both threads. See **pages 15 to 21**.
6. Inspect wound bobbins for proper winding. See **page 79**. Bobbin must turn freely inside bobbin case.
7. Inspect thread take-up spring settings. See **pages 19 and 20**.
8. Check hook and needle relationship. See **pages 9, 41, 43 and 44**.
9. Check timing of needle bar and sewing hook during straight stitching. See **page 43**.
10. Check position finger in bobbin case base for proper thread space. See **page 42**.
11. Check height of feed dog; its position in throat plate.
12. Check performance of bight control mechanism. See **pages 62 to 67 and 92 to 99**.

**SAMPLE CHECK LIST
FOR SERVICEMAN IN THE HOME**

ITEMS REQUIRING ATTENTION ARE INDICATED BY CHECK MARK:

1. QUALITY OF STRAIGHT STITCHING—CENTRAL _____ RIGHT _____ LEFT _____
2. ZIGZAGS IN STRAIGHT SEWING POSITION STAGGERS
3. FRAYS AND BREAKS SILK THREAD DURING—CHAINING _____ #25 STITCH _____
FRAYS AND BREAKS MERC. COTTON THREAD DURING—CHAINING _____ #25 STITCH _____
FREE-HAND EMBROIDERY ZIGZAG SEWING STRAIGHT SEWING
4. QUALITY OF SATIN STITCH _____
5. QUALITY OF ZIGZAG STITCHING _____
6. QUALITY OF TWIN NEEDLE SEWING _____
7. STALLS ON SATIN STITCHING SEWS IN REVERSE AT "O"
8. MACHINE HARD TO START KNOCKS AT HIGH SPEED
9. NEEDLE RUBS THROAT PLATE LEFT SIDE _____ RIGHT SIDE _____
10. RELATION OF HOOK TO NEEDLE—TOO FAR AWAY STRIKING NEEDLE _____
11. HOOK TIMING—SLOW FAST
12. SKIPS ON STRAIGHT STITCHING ON ZIGZAG
13. MACHINE LOOPS GATHERS
14. HOOK RATTLES FEED NOISY TAKE-UP LEVER
IN LOW POSITION LOOSELY FITTED
15. BIGHT CONTROLS—EASY HARD TO MOVE

NEEDLES AND THREADS

For perfect stitching, the selection of the Class, Variety and Size of a needle to be used must be based upon the design and capacity of the particular sewing machine as well as the work to be accomplished.

For efficient and attractive sewing results, the needle blade is designed to be as slender as possible,

constant, maintaining an identical relationship between short-groove side of all 206 x 13 and 306 x 1 needles and the hook point. Therefore, any increase in the **diameter** of the blade results in a shifting of only the **centerline** of the needle blade away from the hook point.

The distance Y, Fig. 2 from the butt-end of the shank of the needle to the top of the needle eye is constant, regardless of needle sizes,

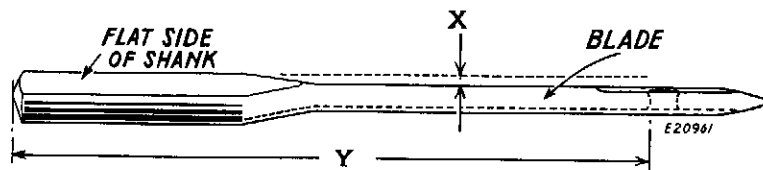

Fig 2. Needle Distances

while sufficiently strong to avoid breakage at the needle eye. Therefore, the size of the needle eye, required by the thread, determines the ideal size of the needle blade. **The actual size number of the needle is based upon the diameter of the needle blade at the eye of the needle. This diameter is constant for all sewing machine needles of the same size number.**

The distance **X** between the short-groove side of the needle blade and the position of the flat-side of the needle shank, seated in the needle bar, is

within all Classes and Varieties of needles recommended for a particular sewing machine. This is to maintain the correct relationship of the height of the needle eye to the point of the hook, throughout all possible changes of needles, as listed for the sewing machine.

However, the size of the needle eye increases with the size of the needle to accommodate heavier thread. Therefore, any **increase** in the length of a needle for one particular machine is made from the **top of the needle eye toward** the point of the needle.

HOOK AND NEEDLE RELATIONSHIP

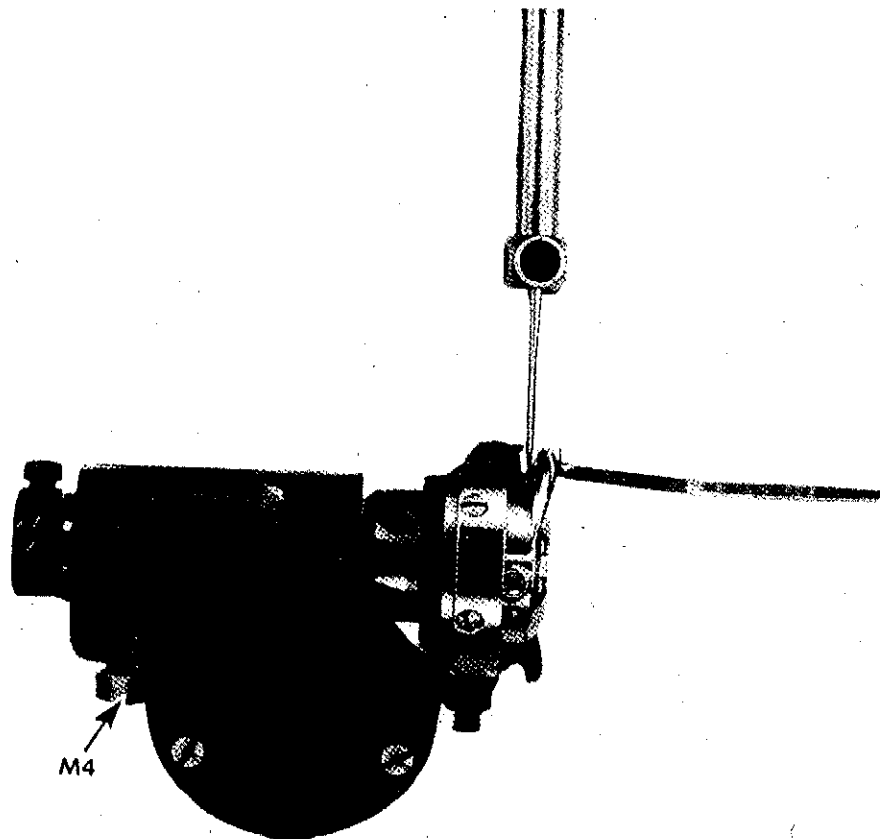

Fig. 3.
Relationship of Hook Point to Needle Eye

The hook point should pass the needle as close as possible, without striking it. This will insure hook point entry of thread loop during ornamental zigzag stitching. Adjust by loosening screw **M4** and proceed as instructed on **page 41**.

**CHART SHOWING RELATIONSHIP OF TYPES OF FABRICS,
THREAD AND NEEDLE SIZES AND
MACHINE STITCHES TO THE INCH**

TYPES OF FABRICS	THREAD SIZES	NEEDLE SIZES	MACHINE STITCHES PER INCH	
			INSIDE SEAMS	TOP STITCHING
Filmy material comparable to Net, Marquisette, Chiffon, Silk and Chiffon Velvets, Voiles, Ninon	Mercerized 00 100 Cotton 00 and 000 Silk Nylon Thread	9	15 to 20	15 to 20
Sheer materials comparable to Lawn, Dimity, Synthetic Sheers, Paper Taffetas, Pure Silks, Gossamer Silks, Silk or Synthetic Tricots, Synthetic Velvets, Satins	Mercerized 0 80 to 100 Cotton 0 Silk Nylon Thread	11	12 to 15	15 to 20
Lightweight materials comparable to Gingham, Chambray, Pique, Poplin, Percalé, Cretonne, Chintz, Faille, Bengaline, Wool Flannel, Wool Jersey, Wool Crepe, Cotton Velvets and Velveteens, Lightweight Suitings	Mercerized 50 60 to 80 Cotton A Silk Nylon or Dacron Thread	14	12	15 to 18
Medium heavy materials comparable to Corduroy, Crash, Gabardine, Rep, Heavy Suitings and Coatings	Heavy Duty Merc. 40 40 to 60 Cotton	16	10	12
Heavy materials comparable to Sailcloth, Denim, Ticking, Overcoatings	30 to 40 Cotton Dacron Thread	18	8	10
Plastic materials	Mercerized 50	9 or 11	10	12

TWIST OF THREAD

For ordinary stitching, either right or left twist thread can be used in the needle and in the bobbin.

To determine twist of thread, hold thread as shown at right and turn thread over toward you between thumb and forefinger of right hand. If thread is left twist, the strands will wind tighter; if right twist, the strands will unwind.

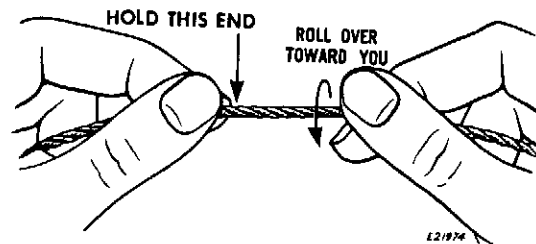

Fig. 4. Determining the Twist of Thread

TO ORDER NEEDLES FOR SWING-NEEDLE MACHINES

Single needles for these Machines are of **Class** and **Variety** 206 x 13 and are made in **Sizes** 9, 11, 14, 16 and 18.

The size of the needle to be used depends upon the size of the thread which must pass freely through the eye of the needle.

Do not use rough or uneven thread or thread which passes with difficulty through the needle eye, as such

thread will interfere with the successful use of the machine.

Whenever a machine breaks thread or skips, try the next size larger needle.

Orders for needles must specify the **Quantity** required, the **Size** number, also the **Class** and **Variety** numbers, separated by an **x**.

The following is an example of an intelligible order:
"100 No. 18, 206 x 13 Needles."

DESCRIPTION OF 306 x 1 TWIN NEEDLES

Twin-needles of **Class** and **Variety** 306 x 1, moulded together in one assembly, are made in **Sizes** 11 and 14 for a **maximum bight of 3mm**. Always include desired bight when ordering, as shown by the following example:

"100 No. 14, 306 x 1-3 Needles."

The best stitching results will be obtained with needles sold by Singer Sewing Machine Company.

15 x 1 NEEDLES FOR MACHINES OF CLASS 401

These machines use needles of **Class** and **Variety** 15 x 1, available in sizes 9, 11, 14, 16 and 18.

TO PREVENT BREAKING OF NEEDLES

The most common cause of needle breakage is the pulling of the material by the operator, while the machine is sewing. This practice is entirely unnecessary, as the machine (when properly adjusted) will feed the material correctly without assistance.

Attempting to perform zigzag stitching, while the machine is fitted with straight stitching throat plate or presser foot, will also cause breaking of needles.

The needle may break unless it is correctly located in the needle clamp, as instructed on **page 12**, or

unless the correct relative position between the needle, throat plate and presser foot is maintained, as instructed on **page 52**.

The needle or the hook point may break unless the machine is correctly timed, as instructed on **pages 41** and **43**.

NOTE: Do not exceed number three on bight control when sewing with twin needles, otherwise bending or breakage will occur.

LOCATION OF NEEDLE IN NEEDLE CLAMP

If the needle is incorrectly placed in the needle clamp and is incorrectly threaded, the machine will not sew.

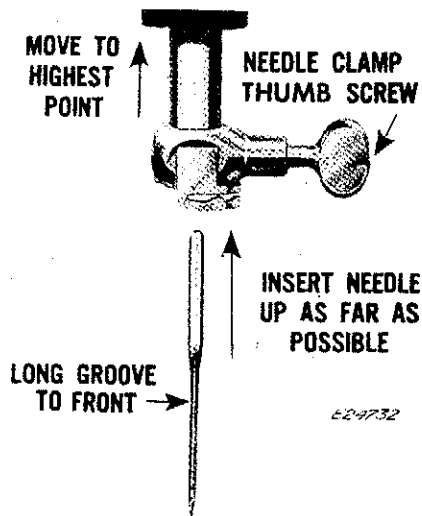

Fig. 5. Setting the Needle

Fig. 6, facing the rear of machine, away from the operator, then securely tighten needle clamp thumb screw.

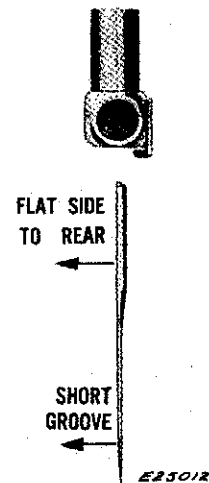

Fig. 6. Flat Side of Needle (Enlarged)

Make sure that needle is **not** blunt or bent.

Loosen needle clamp thumb screw and insert needle in the needle clamp slot, all the way up against the stop, with the flat side of the shank of the needle, see

You will note from Fig. 6 that the side of the needle with the flat on the shank has a **short** groove at the eye, while the opposite side, shown in Fig. 5, has a **long** groove. On all machines the needle is threaded from the long groove side toward the short groove; thus the needle on this machine is threaded from front to rear.

FORMATION OF THE LOCK STITCH

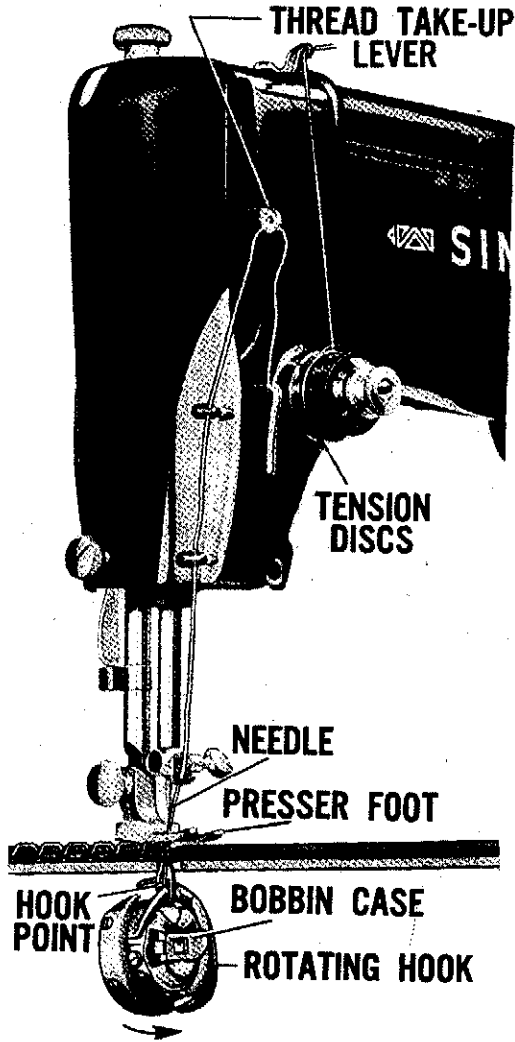

Fig. 7. Point of Hook Entering Loop of Needle Thread

Fig. 7 shows the **first stage in stitch formation**. The thread leading to the needle is slack because the **thread take-up lever has begun its descent**. The needle, after reaching its lowest point, rises to form a loop of thread for the hook point to enter.

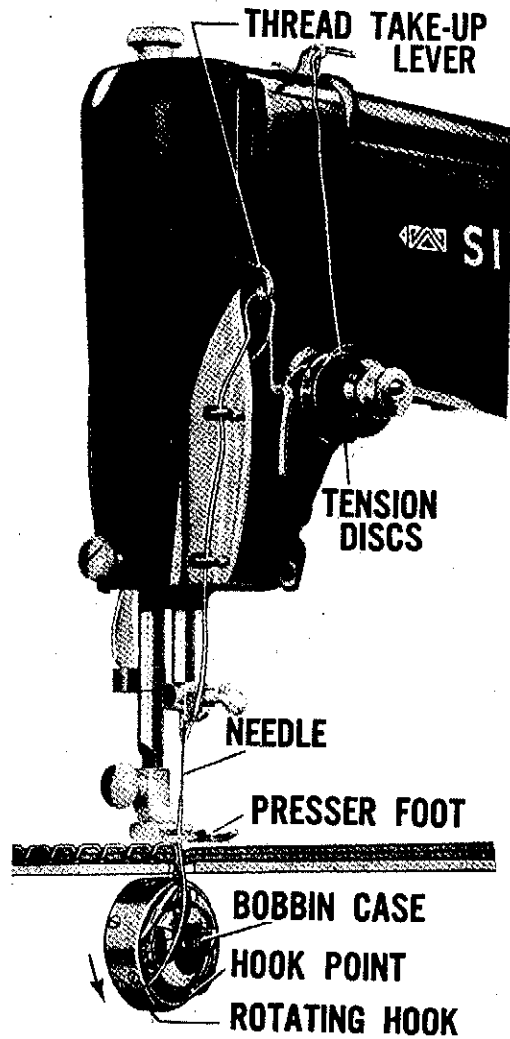

Fig. 8. Loop of Needle Thread Enclosing Bobbin Case

Fig. 8 shows the **second stage**. The hook is so timed as to enter the thread loop and carry the loop around the bobbin case containing the bobbin thread. Take-up lever, in descending, furnishes all the thread required to enlarge the loop for passage around bobbin case.

FORMATION OF THE LOCK STITCH (Continued)

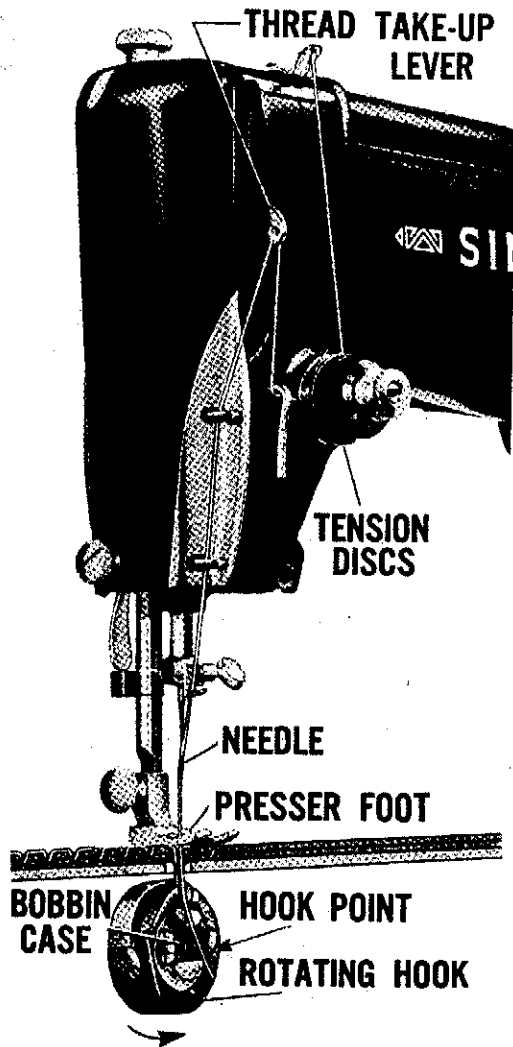

Fig. 9. Bobbin Thread Enclosed by Needle Thread

Fig. 9 shows the **third stage**. The loop of the needle thread has been **cast off** the hook and the take-up lever is rising quickly to take up all the slack thread.

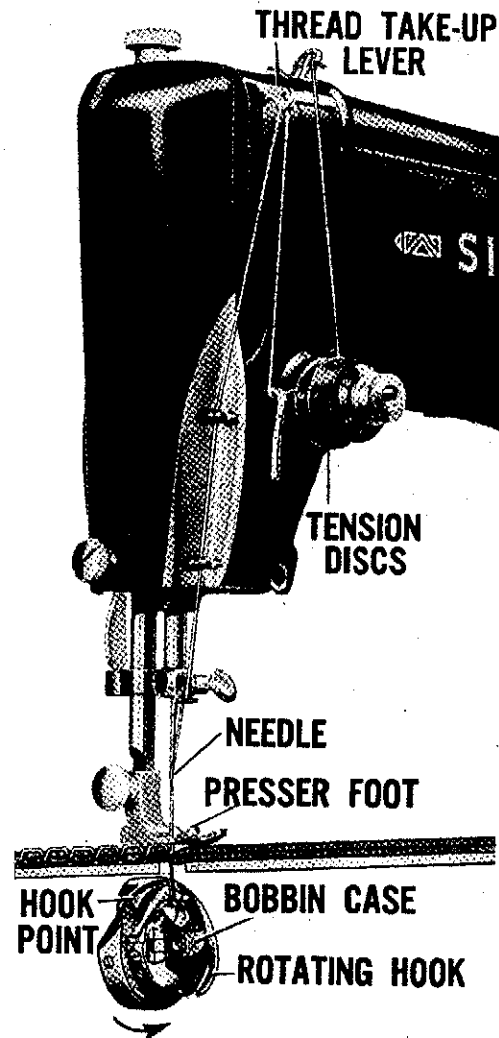

Fig. 10. Stitch Completed

Fig. 10 shows the final stage of locking the stitch. As the take-up lever rises to its highest position, the feed dog is completing its forward motion, thus locking the two threads into a lock stitch.

THE PERFECT LOCK STITCH

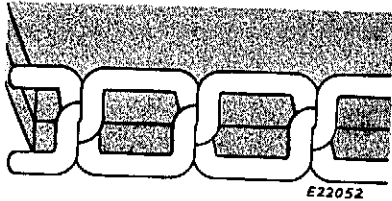

Fig. 11. Cross Section View of Perfect Lock Stitch

When the tensions of both the needle thread and the bobbin thread are correctly adjusted, the stitches will be locked in the center of the thickness of the material, as shown in **Fig. 11**.

When the tension of the **needle thread** is set **too tight** in relation to the **bobbin thread**, excess bob-

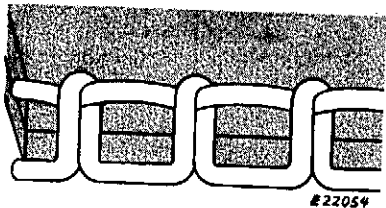

Fig. 12. Cross Section View of Lock Stitch with Tight Needle Thread Tension

bin thread is drawn to the top of the material, causing a **loose stitch**, as shown in **Fig. 12**.

When the tension of the **needle thread** is set **too loose** in relation to the **bobbin thread**, excess needle thread is drawn to the bottom of the material and the bobbin thread may lie straight along the underside of the material, as shown in **Fig. 13**.

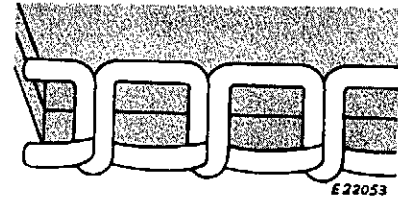

Fig. 13. Cross Section View of Lock Stitch with Loose Needle Thread Tension

Irregular stitching, such as is shown in Fig. 14, is usually caused by a combination of two or more of the following conditions:

- a. Too loose or too tight needle thread tension.
- b. Too loose or too tight bobbin thread tension.

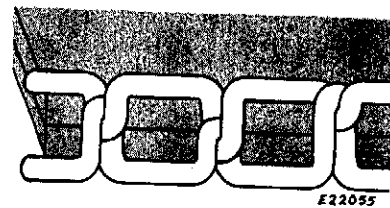

Fig. 14. Cross Section View of an Irregular Lock Stitch

- c. Damaged or improperly set tension spring on bobbin case.
- d. Worn or damaged position finger.
- e. Bent needle or damaged needle eye.
- f. Improper feeding of material.
- g. Use of wrong needle and thread combination.
- h. Incorrect feed time.

TENSION CONDITIONS

When checking and adjusting machine for tension conditions in relation to perfect sewing, use a Size 14 needle and "A" silk thread. Silk thread should be used to establish proper "O" setting of needle thread tension and bobbin thread tension should be adjusted with silk as described on **page 21**. After completing sewing tests with silk, repeat these tests with #50 mercerized cotton thread. Silk thread will show up any tendency for the machine to skip, fray or break thread before such conditions would be noted with mercerized thread.

Test the machine at the following settings:

1. Straight sewing at left-, central and right-hand position of needle and at both longest and shortest stitch setting.
2. Maximum zigzag stitching at extreme left- and right-hand position of needle and at both longest and shortest stitch settings.

STRAIGHT STITCHING

The amount of needle thread tension required to make a satisfactory straight stitch will vary with each machine. A closely fitted hook may require between #5 and #7 on dial tension. A loosely fitted hook may require between #4 and #6. The safest test to insure

proper tension of machine is to start with longest stitch and make sure that no looping appears in the stitching. Then shorten stitch to approximately #25 and note whether or not tension is satisfactory. If noticeable variations occur, make sure all traces of the tacky anti-rust oil are removed from the polished surfaces of the sewing hook and tension parts. **See instructions on page 4**. Failure to wash the hook with Varsol and to oil it after cleaning, may result in many forms of looping trouble.

SATIN STITCHING

When satin stitching, feed and tension adjustments must be very carefully made to insure a uniform quality of satin stitch. Cording of fabric can be expected if excessive needle thread tension is employed or if "O" dial tension setting is too high.

OPEN ZIGZAG STITCHING

On open zigzag stitching it is not always possible to lock the stitch in the corners without cording the fabric unless 1 or 2 thicknesses of some crisp underlay, such as organdy, are used. When underlay is used, additional needle thread tension may be required to lock the stitch in the corners.

SEWING DIFFICULTIES	CAUSES	REMEDIES
Irregular setting of stitches with large beads showing on the underside of the fabric.	Needle too small for size of thread.	Use correct needle. See page 10 .
	Too little needle thread tension. Faulty take-up spring action.	Increase upper tension. Check stroke of spring—replace if necessary. See pages 19 and 20 .
	Clogged or sticky sewing hook.	Free hook of any threads, gum or other foreign matter. If necessary replace hook and bobbin case holder.
	Insufficient thread space.	Provide .020 inch thread space between bobbin case holder and position finger. See page 42 . Inspect finger for roughness.
Fabric drawing on open zigzag stitch of medium stitch length.	Needle thread tension too tight.	Reduce tension.
	Pressure on take - up spring is too great.	Reduce pressure on take-up spring. See page 20 .
Fabric drawing on all short zigzag stitching from medium to maximum bight.	Needle thread tension too tight.	Reduce tension so that material is not drawn yet stitch lies flat. Underside stitching will not lock in corners but in between needle perforations.
Material drawing when sewing with Silk, Nylon or Dacron Threads.	Upper tension too tight.	Tension must be lighter for synthetic threads than for cotton. Reduce tension.
Machine skipping at extreme left or right needle position when sewing with Silk or Nylon threads.	Material may be flagging with needle. Needle may be bent or setting too high.	Use a solid foot in place of a hinged foot. Replace needle. Check height of needle bar in relation to hook. See pages 44 and 45 .

All adjustments on needle thread tension, see **page 18**, should be made on the assumption that the

bobbin thread tension is correctly set at the factory and should not be unnecessarily disturbed.

TO REGULATE THREAD TENSIONS

NEEDLE THREAD TENSION

This machine is equipped with a one-cycle dial tension which, when set correctly, offers a barely perceptible tension at "O" to a maximum at the end of one complete turn of thumb nut.

At "O" there should be a barely perceptible amount of tension, as otherwise, difficulty may be experienced when sewing with twin needles, satin stitching and other forms of closed ornamental stitching.

Pull thread through tension discs to test amount of tension on thread at "O" position. At this point there should be a slight pull on the thread to indicate there is a minimum tension which gradually increases with the turning of thumb nut **A** to the right, providing a full range of tensions with one revolution of the thumb nut. If the pull is too strong for a minimum tension, press in dial **C** to disengage pin **B** on nut from dial, and reset pin in next hole to left of previous setting. Repeat this adjustment until a point is reached

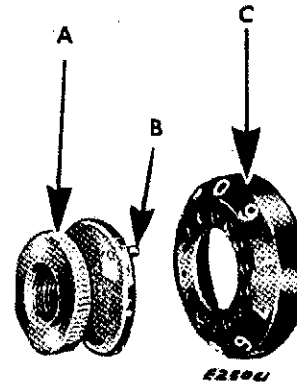

Fig. 15. "O" Setting

of no tension. Then advance one hole to right to give minimum tension at zero position.

TO OBTAIN INCREASED TENSION RANGE

On some occasions a slight increase in maximum range of needle thread tension may be required for special work.

The additional tension may be obtained by using tension indicator No. 125415 and tension spring No. 45869 if the machine is not equipped with these parts.

TO REMOVE AND DISASSEMBLE NEEDLE THREAD TENSION

Turn thumb nut **A** over to the left (counter-clockwise) until it stops. To separate pin **B** in thumb nut **A** from dial **C**, press in dial, unscrew thumb nut and

remove it. Then remove tension parts from stud as shown in **Fig. 16**.

TO REASSEMBLE AND REPLACE NEEDLE THREAD TENSION

Place tension parts on the stud as illustrated:

1. Make sure tension discs are free of oil, grit or grease.
2. Indicator must show plus and minus signs at top for operator's convenience.
3. Tension spring must be mounted so the half coil at front is in the lower position.
4. Finger of slotted washer must point upward to act as a stop for dial.

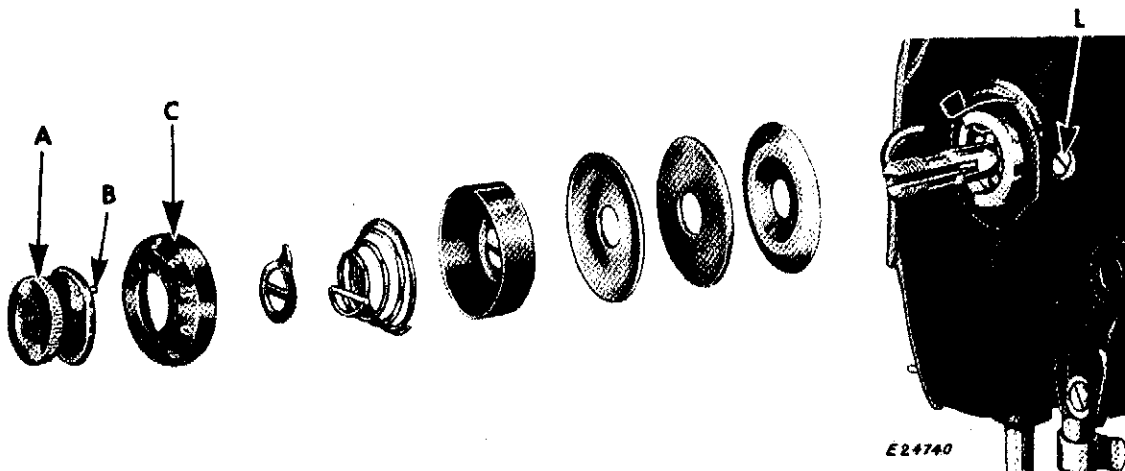

Fig. 16. Needle Thread Tension Assembly

TO ADJUST THE THREAD TAKE-UP SPRING

STROKE OF SPRING

The take-up spring **J**, Fig. 17 should be at rest against its stop as the point of the needle enters the fabric.

When adjusting take-up spring, the stroke must be adjusted first, then followed by the pressure of the spring.

TO SET TAKE-UP SPRING STROKE

Loosen set screw **L**, Fig. 17.

Rotate tension stud **Z** clockwise with a screwdriver (turning whole tension assembly) to complete its action later.

Rotate tension stud **Z** counter-clockwise with a screwdriver (turning whole tension assembly) to complete its action earlier.

Securely tighten set screw **L**.

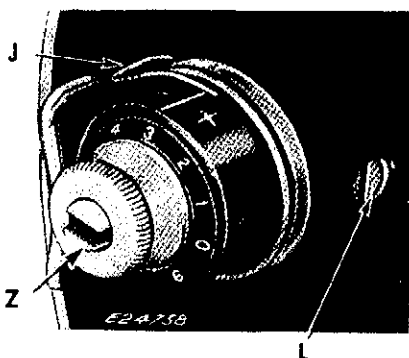

Fig. 17. Setting Stroke of Spring



Fig. 18. Removing Tension Assembly

PRESSURE OF SPRING

Tension on thread take-up spring should be just sufficient to take up slack of needle thread until needle point reaches the fabric.

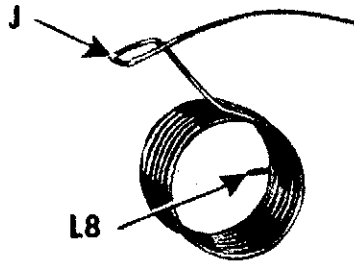

E25055

Fig. 19. Showing Spring

Insert assembly into machine with plus and minus signs of indicator in uppermost position and hold tension assembly in place.

Move loop of spring to the left so that it may come to rest against its stop.

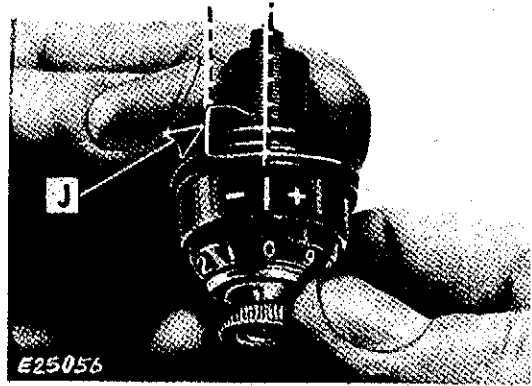

Fig. 20. Spring Left of Center Line

Excessive pressure will cause fabric to cord (draw) during satin stitching or wide bight zigzag stitching.

Insufficient pressure will cause looping or thread breakage.

TO ESTABLISH MINIMUM PRESSURE OF SPRING

Turn screw **G8, Fig. 18** counter-clockwise and remove tension assembly.

Slide spring on tension assembly so that tail of spring **L8, Fig. 19** is in one of the stud slots and top of spring **J**, is just left of center line on indicator in the area between dotted lines, illustrated in **Fig. 20**.

Securely tighten screw **G8, Fig. 18**.

Test pressure of spring to determine if a finer adjustment is needed.

NOTE: If more pressure is required, move small tail of spring **L8** into the next stud slot to the right of previous setting.

If less pressure is required, move small tail of spring **L8** into the next stud slot to the left of previous setting.

NOTE: A very fine adjustment for pressure of the spring can be had by loosening screw **G8, Fig. 18** and turning complete assembly clockwise to increase pressure and counter-clockwise to decrease pressure.

Retighten screw **G8** and test spring pressure by sewing.

TO REGULATE BOBBIN THREAD TENSION

BOBBIN THREAD TENSION

The tension on bobbin thread is regulated by the larger screw nearest the center of tension spring, as shown in **Fig. 21**.

When adjusting bobbin tension, a slight turn of the screw is all that is needed to make a fine adjustment because the full range of tension from zero to a maximum is made within 1-1/4 turns of tension regulating screw.

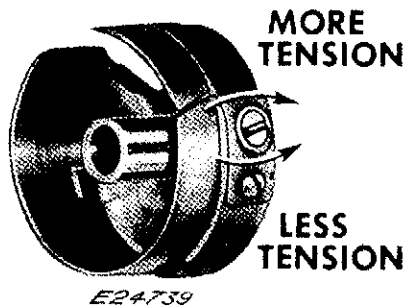

Fig. 21. Bobbin Thread Tension

To increase tension, turn this screw gradually over to the right.

To decrease tension, turn this screw gradually over to the left.

TO REGULATE BOBBIN THREAD TENSION WITHOUT REMOVING BOBBIN CASE

The thread tension screw is conveniently adjusted while bobbin case remains in machine.

To adjust, raise take-up lever almost to its highest point, tilt machine back on its hinges and turn the large screw on the bobbin case as shown in **Fig. 22**.

Turn screw over away from operator to loosen tension or over toward operator to tighten tension.

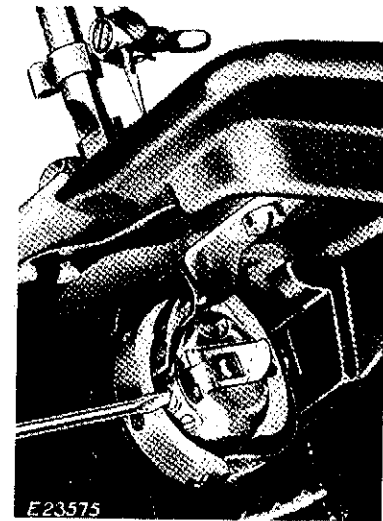

Fig. 22.

SUGGESTED METHOD FOR SETTING BOBBIN THREAD TENSION

Wind bobbin with a 50 yard spool of size "A" silk thread.

Thread bobbin case and adjust tension so that weight of bobbin case with a bobbin of 50 yards of "A" silk will cause case to slide slowly, when held suspended by the thread. See **Fig. 23**. For correct tension, its downward movement should be **very slow**.

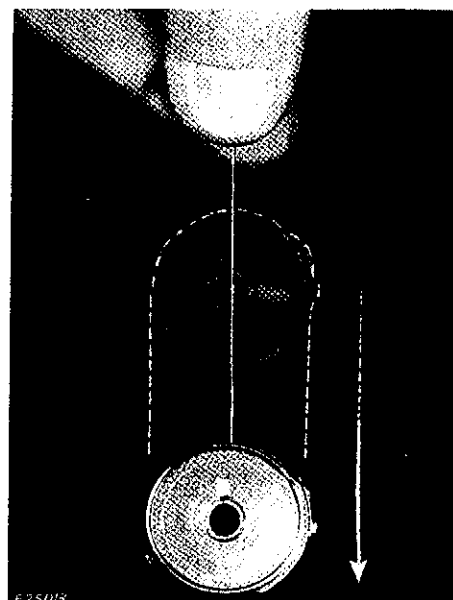

Fig. 23. Checking Bobbin Thread Tension

TO CORRECT THE POSITION OF THE NEEDLE IN RELATION TO STRAIGHT-STITCHING THROAT PLATE

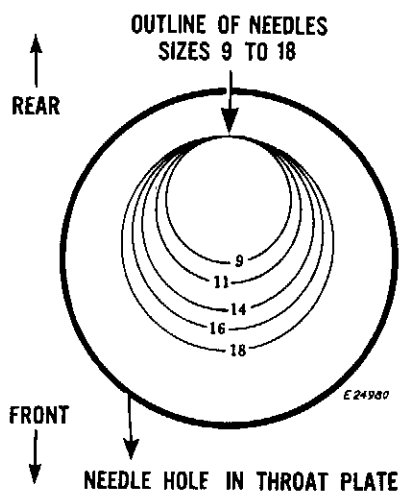
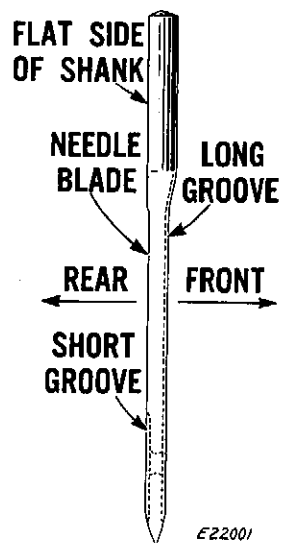

Fig. 24. Needle Hole in Straight-Stitching Throat Plate

When the needle enters the needle hole in **straight-stitching throat plate**, the short-groove (flat shank) side of the needle should be close to the rear edge of the needle hole, as illustrated in **Fig. 24**.



**Fig. 25.
206 x 13 Needle**

When the needle is at its lowest position, the short-groove (flat-shank) side of the needle **Fig. 25** should be at the **rear**, close to a point on the straight-stitching presser foot **midway** between the toes of the presser foot.

This position is necessary to permit an increase in the diameter of the needle blade toward the front without disturbing the proper relationship between the needle and the sewing hook. This position of the needle will also maintain sufficient clearance for the needle thread.

MACHINE SET FOR STRAIGHT STITCHING AT CENTRAL POSITION

At no time should the needle touch the edge of the needle hole. The needle should never strike the presser foot.

If the needle is incorrectly located in the throat plate hole:

Pendulum setting may be incorrect.

Needle or the needle bar may be bent.

Needle seat in the needle bar may be clogged with dirt or be damaged.

Throat plate may be incorrectly seated.

If the needle strikes the presser foot, any of the above conditions may be at fault, or:

Presser bar may be bent, damaged or turned out of position.

Presser foot may be improperly seated on the presser bar.

Presser foot may be bent.

HINTS FOR ADJUSTERS AND MECHANICS

CHECK THESE POINTS WHEN A MACHINE BINDS

1. Bent or cracked bed (transit damage).
2. Needle clamp striking needle bar holder.
3. Bent needle bar.
4. Tightness in needle vibrating forked assembly.
5. Bent take-up lever.
6. Radial misalignment of needle bar holder at hinge bearing.
7. Arm shaft thrust collar (at front of arm) set too close.
8. Bent needle vibrating pitman.
9. Worm gear on cross shaft set too close to arm.
10. Misalignment of disc follower bracket on hinge shaft.
11. Dented arm side cover interfering with needle vibrating linkage.
12. Location of sprocket on arm shaft.
13. Loose bobbin winder belt cover fastening screw.
14. Insufficient clearance between arm and hand wheel bushing for heat expansion.
15. Insufficient clearance between lower sprocket and bearing.
16. Proper location of feed advance eccentric (closest to sprocket).
17. Tightness of hook driving shaft at feed lifting eccentric.
18. Tightness in feed lifting shaft sub-assembly (bind in cross shaft and misalignment of feed lifting fork).
19. Feed bar stop screw setting too high.
20. Feed dog striking top of hook and ends of throat plate slot or rubbing side of throat plate.
21. Hook shaft collar set too close.
22. Hub of hook rubbing against gear housing; also screws rubbing against gear housing.
23. Insufficient thread space.
24. Hook jammed with thread.
25. Hook shaft bushing is "floating," though fastening screw may be tight.

26. Feed lifting crank slide block striking throat of feed bar fork.

NOTE: In changing arm top covers, the rear screw may bind the sprocket because of differences of depth of recess in cover.

WHEN STITCH REGULATOR BINDS

If a binding condition is noted when stitch regulator handle is moved, trace the source of trouble by following, in the order given, the steps outlined:

Disconnect connecting link by removing eccentric stud to isolate source of bind.

1. If bind seems to be in stitch regulator handle assembly, loosen upper set screw in V-block and remove handle. Compress friction spring between fingers to reduce friction against sides of arm. Replace and test again.
2. If stitch regulator handle moves freely, test for binding in
 - a. Feed dog striking ends or rubbing sides of feed slot in throat plate.
 - b. Feed dog striking feed throw-out stop screw.
 - c. Feed dog set too high.
 - d. Feed assembly binding—result of end shake in feed rock shaft.
 - e. Test alignment of connecting link at extreme positions. Misalignment in either position will cause binding. Remedy—replace connecting link.
 - f. Test alignment of feed forked assembly by working connecting rod in up and down motion and turning hook driving shaft in various positions.
 - g. If binding is still present loosen feed fork hinge and pinch screw. Recheck item (f). If side to side movement occurs in fork hinge, replace complete assembly.
 - h. Check for oil shake in feed rock shaft.
 - i. Feed dog slide block sticking in fork of feed bar. Bar should drop of its own weight.

CHECK THESE POINTS WHEN MACHINE BREAKS NEEDLES

If needle is incorrectly located in the needle hole in the throat plate:

1. Try a new throat plate and note whether or not there is improvement.
2. Needle or needle bar may be bent.
3. Needle seat in the needle bar may be clogged with dirt or may have been burred through damage.
4. Throat plate may be incorrectly seated. (Look for paint or polishing compound around periphery of throat plate seat.)

IF NEEDLE STRIKES SEWING HOOK

1. Needle may be incorrectly seated.
2. May be using a large size 15 x 1 needle, in which case point will strike bobbin case.
3. Needle or needle bar may be bent.
4. Radial setting of needle bar may be incorrect for zigzag or twin needle sewing.
5. Needle clamp may be loose.
6. Hook may need retiming.
7. Hook position may need adjusting—move away from the needle.
8. Needle guard or sewing hook may not be correctly related to the needle.
9. Hook may be damaged.
10. Arm or bed position may have been disturbed by severe shock in transit.
11. Too much end play in hook shaft will cause needle interference.
12. Arm shaft connection belt may need retiming. If belt is stretched, replace.
13. Incorrect radial location of bight control device in arm.

IF NEEDLE STRIKES PRESSER FOOT

1. Needle may be bent or incorrectly seated.
2. Presser bar may be too high or incorrectly set for proper alignment.
3. Presser foot may be incorrectly seated on presser bar.
4. Presser bar may be bent or damaged.

IF THROAT PLATE RATTLES

1. Throat plate may be incorrectly seated.
2. Dirt or paint particles on throat plate seat.
3. Two screws on throat plate spring may be loose or lost.
4. Bent throat plate.
5. Throat plate spring lacks tension.
6. Feed dog rubs sides of feed slots.
7. Collection of lint in feed dog slots.
8. Feed dog screw loose.
9. Feed dog set too high.

CHECK THESE POINTS WHEN MACHINE IS NOISY

1. Noisy hook.
2. End play in hook driving shaft.
3. Loose belt.
4. Feed dog striking hook.
5. Loose-fitting needle bar frame.
6. Loose fit between worm on arm shaft and worm gear on cross shaft.
7. Binding in disc follower bracket.
8. End play in arm shaft.
9. End play in arm cross shaft.
10. Loose thread take-up lever.
11. Tightness in needle vibrating mechanism.

TO REMOVE ARM SHAFT CONNECTION BELT FROM WITHIN THE ARM

To remove arm shaft connection belt proceed as follows:

Remove needle from needle clamp.

Slide belt off lower sprocket.

Loosen stop motion stop screw **N**, Fig. 26 and remove the following parts:

Clamp screw **O**

Washer **P**

Hand wheel **Q**

Flanged bushing screw **S** and bushing **R**

Three arm shaft bushing screws **U** with bobbin winder complete

Arm top cover



Fig. 27. Drawing the Belt Out of Arm

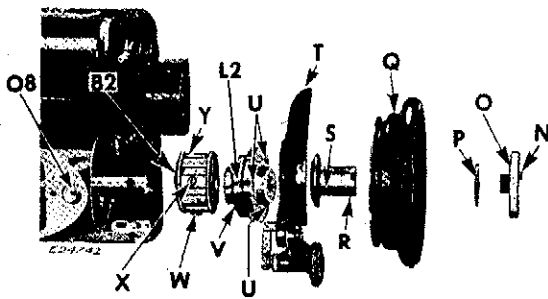

Fig. 26. Removing and Replacing Arm Shaft Connection Belt

Lift belt to left of arm shaft sprocket and loosen sprocket screws **X** and **W**, Fig. 26 so that heads of screws are flush with surface of sprocket.

Press oil wick down at **O8** so that it will not interfere when removing rear arm shaft bushing **V**.

To remove arm shaft bushing **V**, press fingers against sprocket to ease sprocket and bushing out until bushing is free from bearing in casting. (If bushing resists finger pressure, use 5/16 inch brass drift punch against side of sprocket to ease bushing past arm bearing.)

Remove sprocket **Y**.

NOTE: Purchase 5/16 inch brass rod at local hardware and mill supply store.

Insert finger through arm shaft hole and inside loop of belt. Then snake out belt as shown in Fig. 27.

TO REPLACE ARM SHAFT CONNECTION BELT

With seam clips on inside of belt, form loop with belt and slide along shaft as shown in **Fig. 28**. Grasp belt with left hand as shown in **Fig. 29** and pull belt through top of arm until bottom of belt clears arm shaft hole. Then drape upper half of belt over arm as shown in **Fig. 30**.

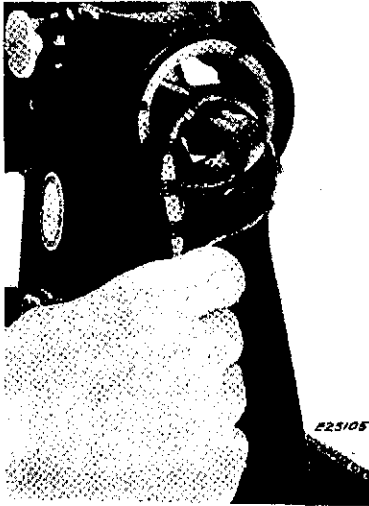

Fig. 28. Inserting Belt into Arm Shaft Hole

Replace sprocket so that timing notch in spline of sprocket faces take-up lever end of machine and that set screw **X**, **Fig. 31**, nearest notch, will locate on flat of arm shaft. Slide sprocket inside loop of belt and temporarily fasten timing screw **X** on flat. Sprocket

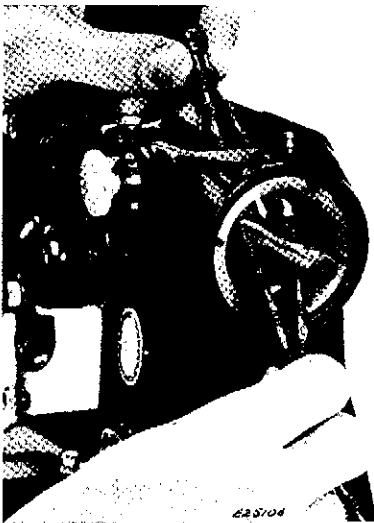

Fig. 29. Drawing Belt into Arm

should locate as close to gear **O7**, **Fig. 31** as possible without striking, to provide adequate heat expansion clearance between sprocket and rear arm shaft bushing.

Slide arm shaft bushing along arm shaft. Align oil hole **L2**, **Fig. 26** in bushing with oil hole **O8**, **Fig. 26** in arm.

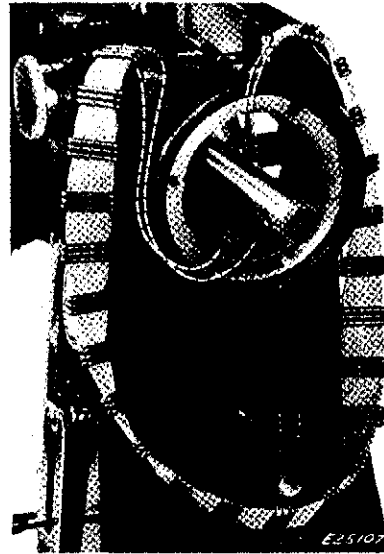

Fig. 30. Draping Belt over Arm

If arm shaft bushing resists finger pressure, make sure there are no burrs along bearing edge. A few light strokes of a file or a light dressing down with very fine emery cloth will help to ease bushing into place.

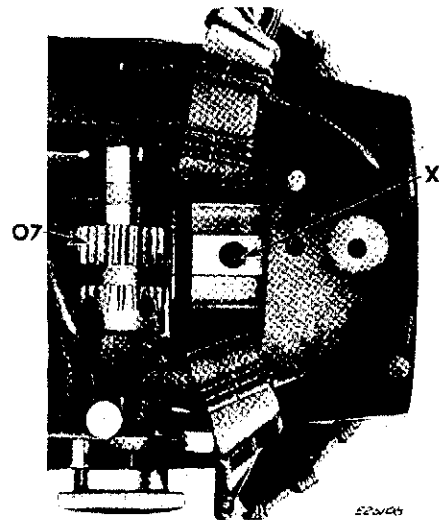

Fig. 31. Locating Sprocket in Relation to Gear

Mount bobbin winder complete, so that screws barely pinch. Insert third bearing screw until it pinches. Then progressively tighten each screw a slight amount until all screws are tightened firmly.

CAUTION: If each screw is tightened, individually rather than gradually, arm shaft will bind or machine will run slowly.

One end of screw hole **K2**, Fig. 32 near end of arm shaft has a seat for hand wheel bushing screw **S**, Fig. 33. This seat, like the large hole in the hand

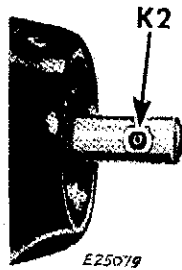

Fig. 32. Screw Seat Near End of Arm Shaft

wheel bushing, must be in the uppermost position to properly fasten bushing in place. Drop screw **S** into screw hole and, just before fastening bushing in place, slide .020 inch Feeler Gauge No. G34203 between bearing and bushing. Push bushing against gauge and then lock the screw in position. This method of locating bushing will insure adequate heat expansion clearance—.020 inch as illustrated in Fig. 33. If more clearance is needed, try .022 to .024 inch.

of the bushing. Replace clamp screw **O**, Fig. 34 and tighten stop screw **N**.

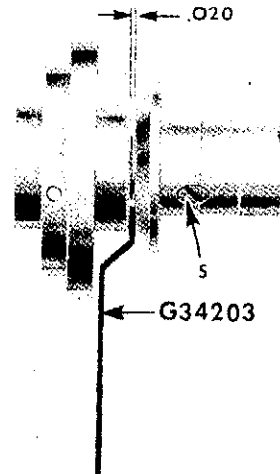

Fig. 33. Heat Expansion Clearance Between Bushings

Loosen timing screw **X**, Fig. 31 in sprocket, then retighten screw, thus allowing screw to find its proper location on flat. Then turn arm shaft approximately 90° over away from you and tighten second screw.

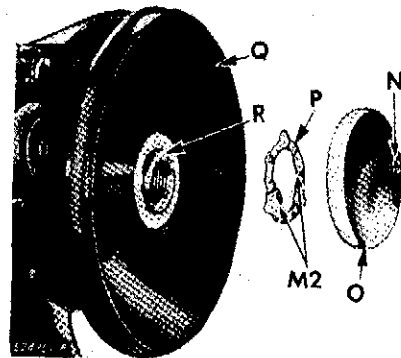

Fig. 34. Replacing Stop Motion Mechanism

LOCATION OF ARM SHAFT SPROCKET

Replace hand wheel **Q**, on flanged bushing, as shown in Fig. 34.

Replace reversible clamp washer **P**, Fig. 34 against hand wheel hub and set prongs **M2** in slots

Pick up belt **A2**, from back of arm and rotate it over finger so that copper clips **C2** may be located into timing spline at **B2** of sprocket **Y**, Fig. 35.

NOTE: Loosen clamp screw **O** and check if hand wheel is free to wind bobbins.

Tilt machine back. Turn lower sprocket on hook driving shaft so that timing spline opposite rear bearing position screw **C4** and mill cut **F8**, **Fig. 37** are aligned. Slide copper clips to edge of timing spline.

Then gradually mount belt by rocking hand wheel back and forth and sliding belt to center of sprocket.

A double check on proper location of belt can be made by making sure that one set of copper clips is in timing spline of lower sprocket at the same time that the set of copper clips in opposite end of belt is in timing spline of upper sprocket.

Replace arm top cover.

Insert needle into needle clamp.

Check the timing of the feed in relation to the movement of the needle, and adjust where necessary, as instructed on **page 29**.

"Run-in" the machine, as instructed on **page 79**.

CARE OF THE ARM SHAFT CONNECTION BELT

Do not lubricate the arm shaft connection belt. To ensure the long life and efficient performance of this belt, it must be kept clean and free from excess oil at all times.

When the arm shaft connection belt becomes loose or worn, it should be removed and replaced, as instructed on **pages 25 to 28**.

TO TIME THE FEED

TWO METHODS

Method No. 1

Feed timing should be checked as follows:

- Remove needle
- Remove presser foot
- Set bight controls in neutral (central straight stitching) position.

Method No. 2

Remove arm top cover.

A close inspection of the arm shaft connection belt **A2**, **Figs. 35** and **36** will reveal that there are two sets of three metal clips, **C2** and **D2** at opposite ends of the belt. Each set includes one black metal clip and two copper clips.

To check the feed time, turn hand wheel over toward you until one set of copper clips shown at **C2** in the belt lies in the upper sprocket groove bearing a timing mark **B2** illustrated in **Fig. 35**.

When belt is correctly timed the lower set of copper clips **D2**, **Fig. 36** will be located in the timing groove of the lower sprocket.

If belt is not correctly mounted, first make sure that screw **C4** opposite timing mark in lower sprocket is located on flat indicated by mill cut **F8**, **Fig. 37** on end of hook driving shaft.

If sprocket is correctly located slip belt off the lower sprocket and turn lower sprocket so as to locate copper clips into groove with timing mark.

CAUTION: When the belt **A2** cannot be removed from lower sprocket without danger of stretching the belt, remove both the lower sprocket and belt

Set stitch regulator at longest stitch

Make sure feed throw-out thumb screw **O2**, **Fig. 39** is tightened in place.

Turn hand wheel to bring take-up lever to its highest position. As take-up lever starts its downward motion, the feed dog is finishing its forward motion and is starting to drop. This relationship of feed to take-up action constitutes the correct feed time.

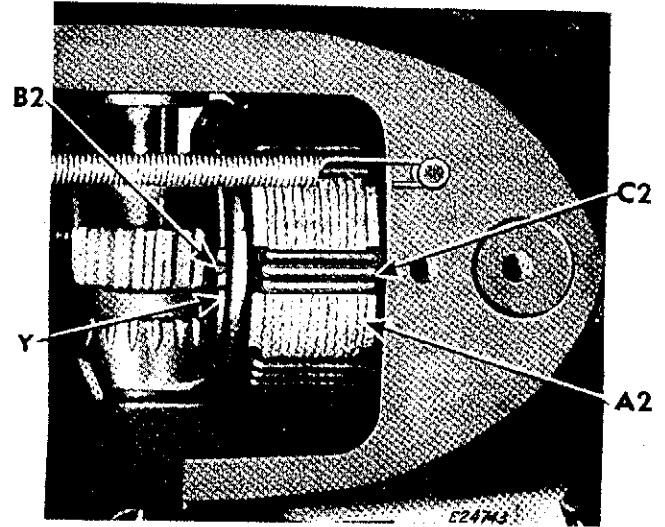

Fig. 35. Feed Timing Mark On Upper Sprocket

from the hook driving shaft **N2**, **Fig. 36**. Check the timing of the rotating hook in relation to the needle as described on **page 43**.

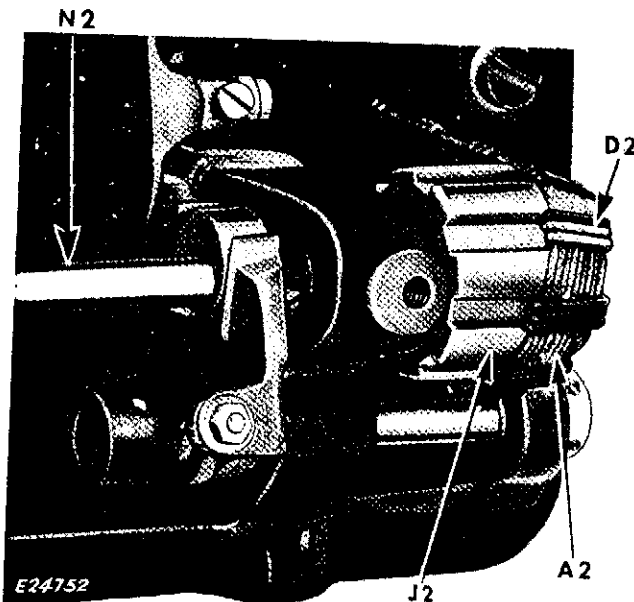

Fig. 36. Timing the Feed

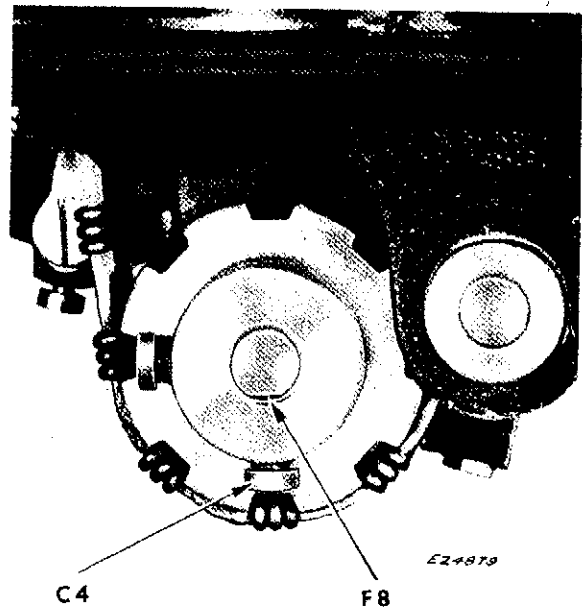

Fig. 37. Mill Cut Guide to Flat on Shaft

TO SET THE FEED DOG AT THE CORRECT HEIGHT

To check the height of the feed dog, tighten feed throw-out thumb screw **O2**, Fig. 39, turning it clockwise as far as possible. Then set the stitch regulator **X2**, Fig. 43, page 33 for the longest stitch.

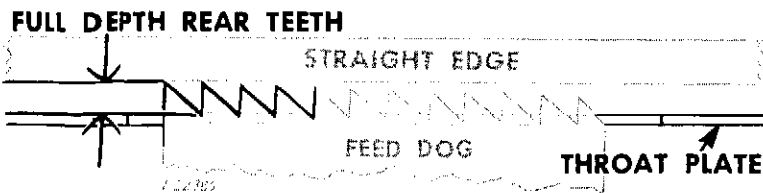

Fig. 38. Feed Dog at Correct Height

Turn the hand wheel over toward you until the feed dog is raised to its highest point. In this position, the full depth of the rear teeth of the feed dog, farthest from operator, should project above the top surface of the throat plate, as shown in Fig. 38. Gauge No. G34202 for setting correct feed dog height is shown in use in Fig. 38A.

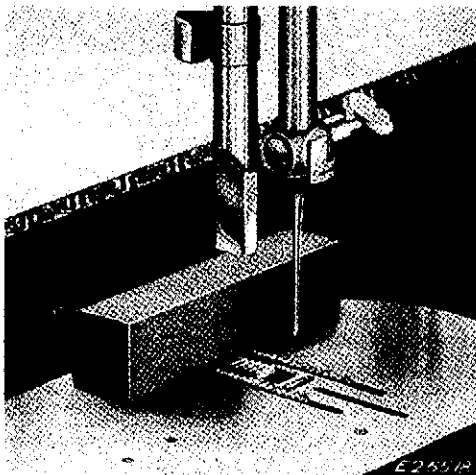

Fig. 38A. Feed Dog Height Being Set with Gauge

Be certain feed dog does not "kick back" as it rises. If it should "kick back," lower feed dog slightly.

To set the feed dog at the correct height, loosen clamping screw **P8**, Fig. 39 and raise or lower the feed dog **Q2**, Fig. 39 as required. Then securely tighten clamping screw **P8**.

NOTE: The feed lifting eccentric is timed to lift feed dog at a particular time in the stitch formation process. For this reason it is not adjustable and is fixed by location of the upper fillister head screw on the flat of the hook driving shaft.

For quick reference the relative location of gear, eccentrics and sprocket is illustrated in Fig. 40 to show which screw correctly locates each part on the hook driving shaft.

On occasion screw **P2** will be loosened to raise or lower feed dog height. In so doing it is possible to inadvertently create end play in the sub-assembly, thus causing noise and binding troubles. Also it is difficult to correctly adjust the feed dog height by this means because in tightening the screw, the feed dog will be lowered instead of maintaining its height.

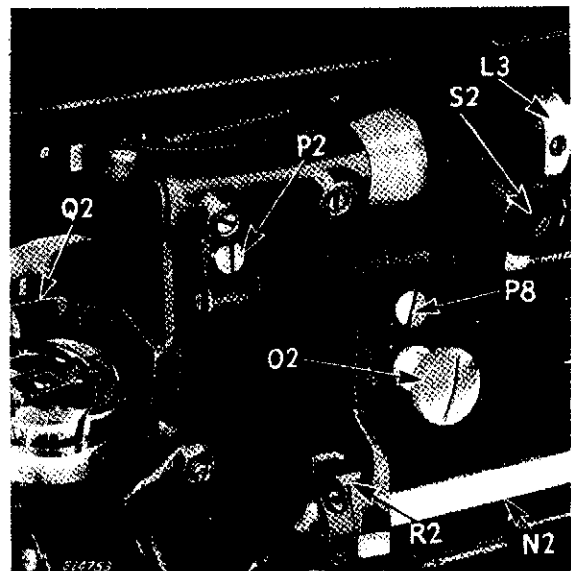

Fig. 39. Adjusting Height of Feed Dog

Screw **P2** should be used only to take up end shake or relieve binding that may exist between crank and collar in feed lifting sub-assembly. When making this adjustment, hold crank and collar gently between fingers.

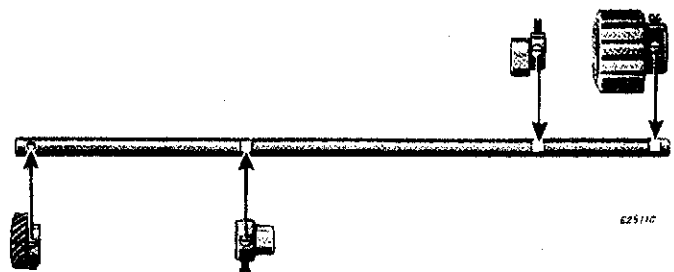

Fig. 40. Location of Gear, Eccentrics and Sprocket on Hook Driving Shaft

TO ADJUST THE POSITION OF THE FEED DOG FOR CLEARANCE ABOVE HOOK

NOTE: See pages 30 and 32 for setting the feed dog height and the position of the feed dog in relation to the throat plate slots. Then proceed to adjust for hook clearance as described below.

For proper clearance above hook, set the stitch regulator at the longest stitch and turn hand wheel toward operator (counter-clockwise) until feed dog is at its lowest point.

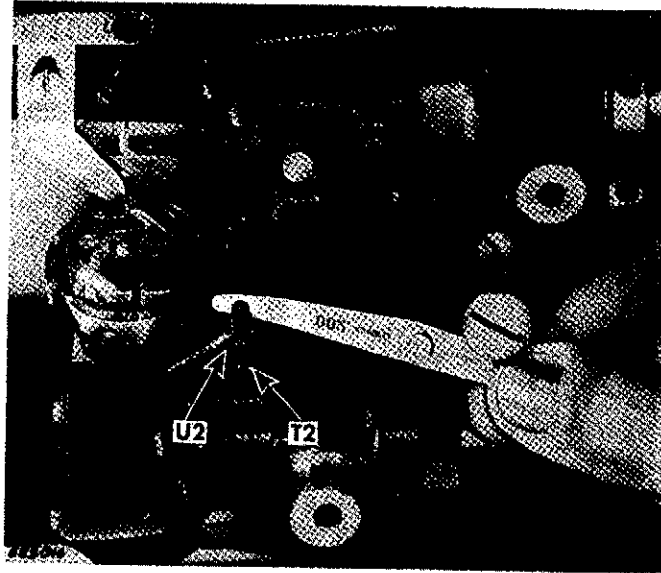

Fig. 41. Adjusting Clearance between Hook and Feed Dog

When setting the feed dog at the correct height as shown in Fig. 38, make sure bottom of feed dog Q2, Fig. 39 clears hook assembly before clamping screw P8 is tightened.

CAUTION: Stop screw T2, Fig. 41 should be set to prevent feed dog from coming in contact with hook assembly and causing serious damage to sewing hook and feed mechanism.

Loosen stop screw nut U2 and turn stop screw T2, Fig. 41 until top of screw just touches the feed, then back off on screw and maintain .005 inch clearance with feeler gauge, Serial No. 187928.

Lock stop screw in this position by holding screw with a screwdriver and turning stop nut U2, with a wrench.

Turn hand wheel toward operator and recheck clearance.

TO SET THE FEED DOG IN RELATION TO THE THROAT PLATE SLOTS

NOTE: Set the machine for longest stitch before making any adjustments of the feed dog.

Set bight controls for straight stitching at central position.

Tighten feed throw-out thumb screw **O2**, Fig. 39.

SIDewise ADJUSTMENT

The feed dog should be located centrally in the feed dog slots in the throat plate without rubbing the sides of the slots at any time.

To adjust the **sidewise position** of the feed dog, loosen feed rock shaft bearing set screw **S2**, Fig. 39 and loosen the two screws on collar **L3**.

Tap collar toward the left very lightly with a hard rubber mallet to move feed bar assembly toward the left.

Tap feed bar supporting bracket toward the right with rubber mallet to move feed dog toward the right.

Securely tighten set screw **S2** and tighten two screws on collar **L3** without binding.

CAUTION: To avoid binding of feed forked connecting link **V2**, Fig. 42, after adjusting **sidewise position** of the feed dog, loosen clamping screw **W2** in the feed rock shaft crank. Move crank to left or right until it reaches its dead center. Then securely tighten the screw **W2**.

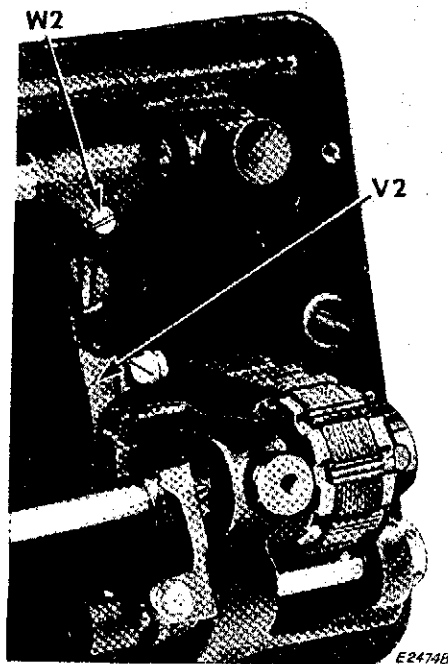

Fig. 42. Adjusting Feed Dog in Throat Plate Slots

LENGTHWISE ADJUSTMENT

Be certain machine is set for longest stitch. See **NOTE** above.

The closer the feed dog is to the needle slot in the throat plate without striking, the better it will be for satin stitching and all other forms of closed ornamental stitching.

To adjust the **lengthwise position** of the feed dog, loosen the screw **W2** and move the feed dog assembly toward the front or rear, as required. Then securely tighten the screw **W2**.

TO ADJUST THE STITCH REGULATOR

The distance between the stitches along the line of feed is termed the **stitch length** and is determined by the setting of the stitch regulator lever **X2**, Fig. 43 on the stitch indicator plate **Y2**.

The divisions, 0 to 4 on the right-hand side of the indicator plate **Y2** signify the stitch length in millimeters, while the divisions on the left-hand side of the indicator plate **Y2** indicate the approximate number of stitches to the inch.

For example: When machine is set at maximum stitch length the machine will sew approximately 6 stitches to the inch or a distance of 4 millimeters (approximately 5/32 inch) between stitches.

The feed eccentric **B3**, Fig. 44 is not adjustable for length of stitch, as it is positively set at the factory by location on a flat on the rotating hook driving shaft **N2**. See Fig. 53, page 39 for location of flats on shaft **N2**.

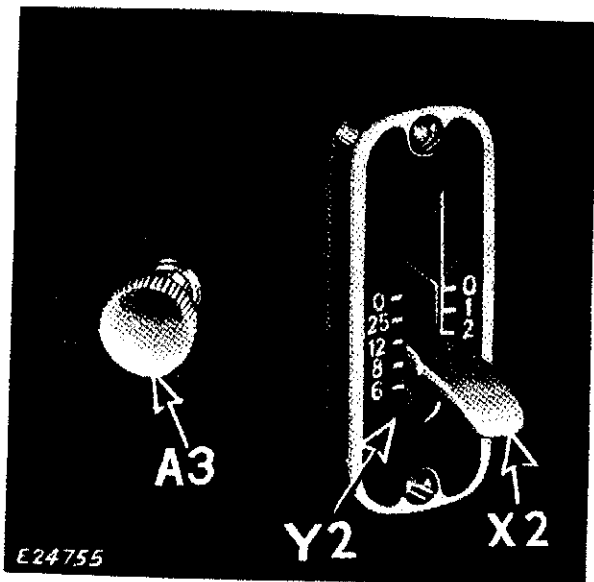

Fig. 43. Stitch Regulating Handle

CHECK THESE POINTS WHEN STITCH REGULATOR STICKS, CREEPS OR BINDS

1. Looseness of screws.
2. Dirt on, or damage of moving parts.
3. Stitch regulator stop screw not turned down fully to hold at selected stitch length.
4. Bent stitch regulator handle.
5. Too much friction in friction fork on stitch regulator.
6. Bent feed regulator connection rod.
7. Worn or bent slide bar in feed forked connection link.
8. Worn or damaged feed rock shaft.
9. Binding in feed rock shaft connecting link **V2**, Fig. 44.

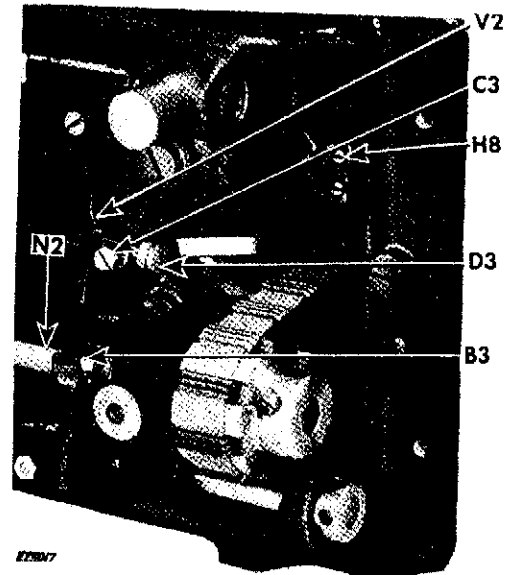

Fig. 44. Adjusting Stitch Regulator

When the top surface of the stitch regulator lever **X2**, Fig. 43 is set level with the "zero" on indicator plate **Y2**, there should be a slight forward movement of the feed so as to get best results in satin stitching.

To adjust "zero" position of the stitch regulator proceed as follows:

1. Lock stitch regulator handle at zero position with stop screw **A3**, Fig. 43.
2. Loosen set screw **C3**, Fig. 44.
3. Turn eccentric stud **D3** until connecting link **V2** is brought to its lowest position.
4. Securely tighten set screw **C3**.
5. Make feed motion test on paper to establish whether or not there is any movement of feed.

TO REMOVE STITCH REGULATOR HANDLE

1. Move stitch regulating handle to zero position.
2. Remove stitch indicator plate.
3. Loosen binding set screw **H8**, Fig. 44 which fastens to stitch regulating handle.
4. Wrap a piece of leather over stitch regulating handle. Then with a slow twisting and pulling motion (using pliers) remove handle as shown in Fig. 45.

TO REMOVE FEED REGULATOR ASSEMBLY

5. Loosen screw **C3**, Fig. 44 and remove eccentric stud **D3**.
6. Remove feed regulator hinge screw **E**, Fig. 47 from back of arm behind motor.
7. Remove regulator assembly through bottom of machine bed as shown in Fig. 46.

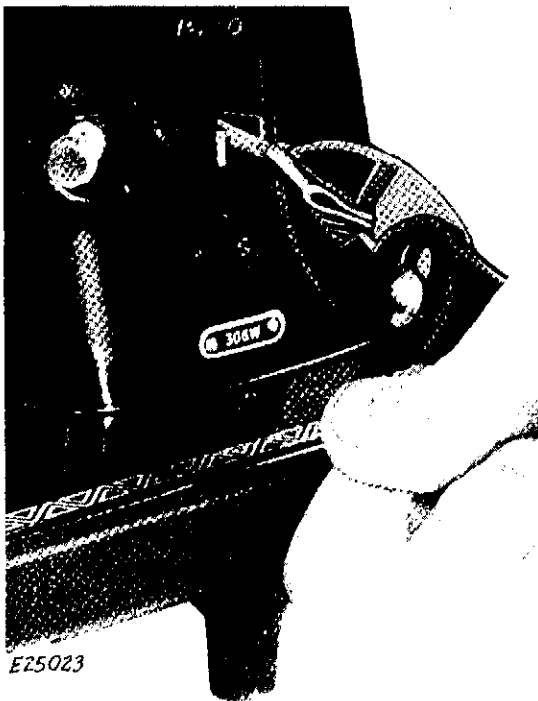

Fig. 45. Removing Stitch Regulating Handle



Fig. 46. Removing Feed Regulator Assembly

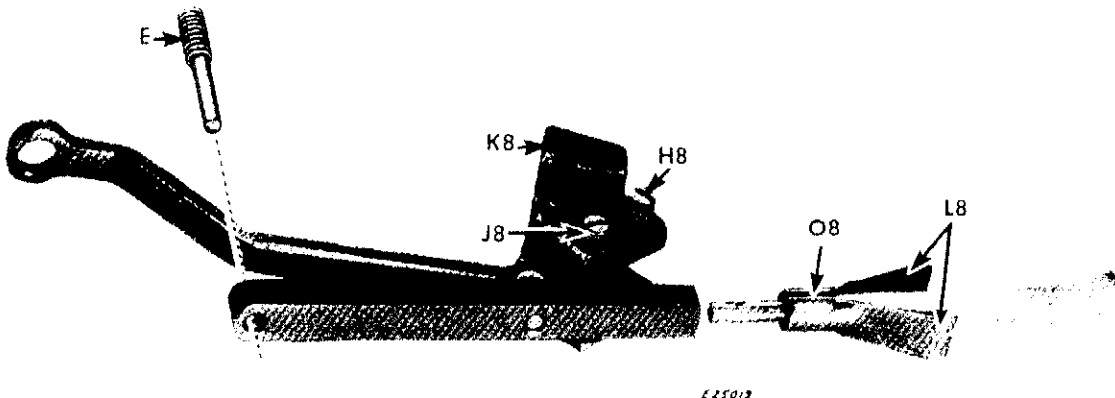

Fig. 47. Showing Feed Regulator Assembly

TO REPLACE FEED REGULATOR ASSEMBLY

1. Insert regulator assembly through bottom of machine bed as shown in **Fig. 46** and insert feed regulator lever in position toward motor.
2. Guide feed regulator hinge screw **E, Fig. 47** into feed regulator lever being careful not to strip threads.
3. Replace eccentric stud **D3** and securely tighten set screw **C3, Fig. 44**.

TO REPLACE STITCH REGULATOR HANDLE

4. Insert stitch regulating handle into its recess and securely tighten screw **H8, Fig. 44** making sure that slotted opening **O8** of friction spring aligns with concave surface of regulator handle as shown in **Fig. 47**.
5. Replace stitch indicator plate.

NOTE: Adjust the zero position of stitch regulator. See **page 33**.

When feed regulator assembly sticks, creeps or binds proceed as follows:

Expand both wings of friction spring **L8, Fig. 47** outward to increase friction and to prevent stitch regulating handle from creeping. If handle sticks or binds, soften pressure of friction spring by compressing spring between fingers.

Slide friction spring **L8** along stitch regulating handle to remove it.

Loosen lock set screw **J8, Fig. 47** to remove feed regulator stop block **K8**. When stop block is replaced, tighten lock screw **J8** but do not tighten screw **H8** until feed regulator is placed in machine and stitch regulating handle inserted.

TO REMOVE A BROKEN OR FAULTY FEED FORKED CONNECTION ASSEMBLY

To remove the assembly, loosen screws at **W2**, **L3**, **J3**, **H3**, **C3** and remove eccentric stud **D3**, **Fig. 48**.

If only the right end of shaft touches the right bed leg, then give the crank a slight twist to the left by pivoting shaft to the left until shaft simultaneously touches both legs.

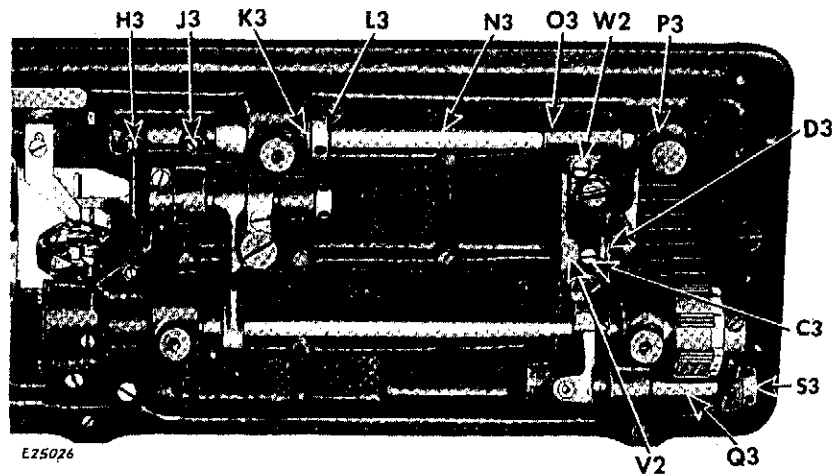

Fig. 48. Showing Feed Forked Connection Assembly

Hold feed rock shaft crank **O3**, **Fig. 48** with the right hand and with the left hand slowly slide shaft **N3** out toward hand wheel end of machine without bending feed rock shaft connecting link **V2**.

Replace shaft into rock shaft crank only as shown in **Fig. 49**.

When the shaft simultaneously touches ends of the two bed legs, then test shows correct alignment of feed forked connection to rock shaft.

If only the left end of shaft touches the left bed leg, then give the crank a slight twist to the right by pivoting shaft to the right until shaft simultaneously touches both ends of bed legs.

Remove collar **S3** by loosening two screws.

Remove shaft from crank, then snake out feed forked connection as shown in **Fig. 50**.

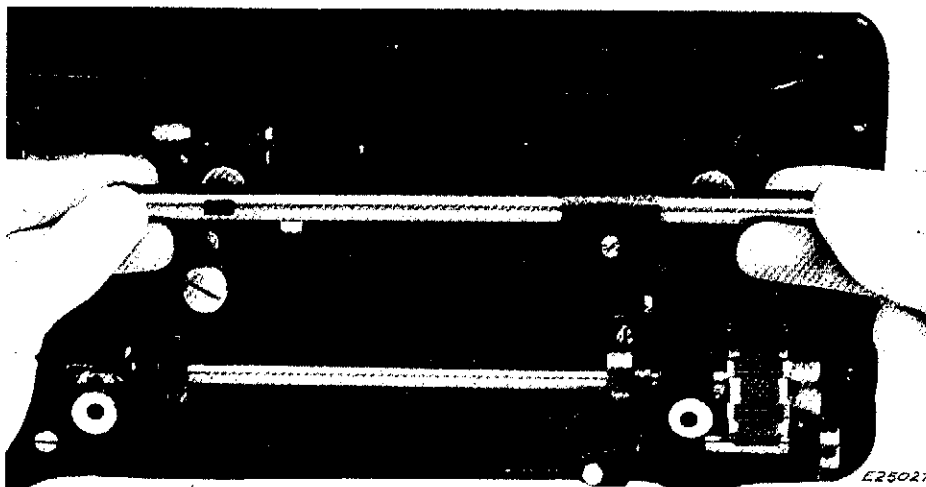

Fig. 49. Checking Feed Forked Connection

TO INSTALL A FEED FORKED CONNECTION ASSEMBLY

Slip assembly between hook shaft and bed of machine as shown in **Fig. 50**.

Insert shaft into bushings **R3** while simultaneously guiding inside fork edges over sides of cam **B3**, **Fig. 50**.

Slip collar **S3**, **Fig. 48** (beveled edge out) on shaft and tighten two screws without binding against bushing.

While holding crank end **O3**, slide feed rock shaft through bushing **P3** and into crank **O3**. Be sure that end of shaft with flat is inserted first so that screw **J3** can locate on it.

Replace collar **L3** (beveled edge toward right) on feed rock shaft.

Guide shaft into bushing **K3** until flat mark on shaft is directly under screw **J3**.

Tighten screw **J3** over flat mark on shaft, then tighten screw **H3**.

Push collar **L3** against bushing **K3** and tighten two collar screws without binding.

Insert eccentric stud **D3** through connecting rod and into connecting link **V2**, then tighten screw **C3**.

Before tightening screw **W2**, take-up lever should be at lowest position and feed dog should be set as close to needle slot as possible without striking when machine is set for longest stitch. See "Caution" on **page 32**.

NOTE: Check stitch regulator for "zero" position. See **page 33**.

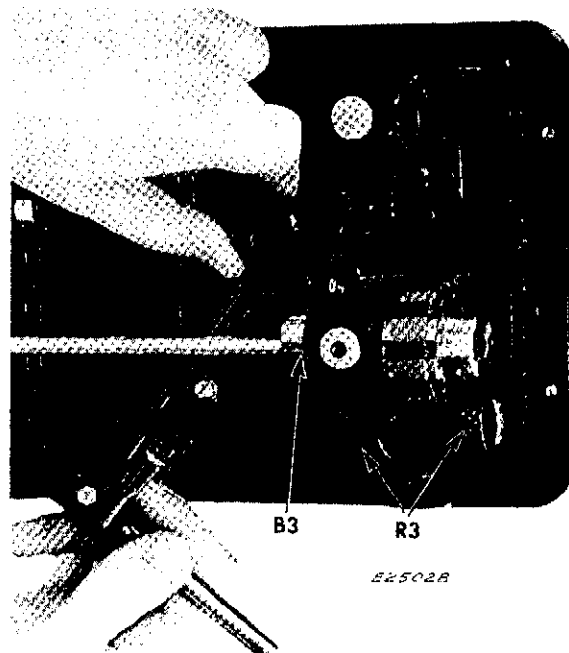

Fig. 50. Removing Feed Forked Connection

TO REMOVE END PLAY OR BINDING IN ROTATING HOOK DRIVING SHAFT

TESTS FOR BINDING

1. Loosen feed eccentric screws **W3**. Turn hand wheel over several times, then retighten.
2. Check for fork jaw interference with either eccentric collar.
3. Slip belt off and turn sprocket. If shaft binds, trouble may be due to

Sprocket set too close to rear bearing bushing. See **Fig. 56**.

Bed may be bent or cracked.

Gear may be binding in gear case.

Shaft may be bent.

There should not be end play or binding in the rotating hook driving shaft **N2**, **Fig. 51**.

To remove end play or binding in the hook driving shaft **N2**, loosen the two screws **W3**, **Fig. 51**.

Push the feed lifting eccentric **R2** sufficiently hard against the right end of the bushing **Y3** to remove end play without binding.

Securely tighten the two screws **W3**, making sure that the second of the two screws, as the hook driving shaft is rotated over toward you, is on the flat of the hook driving shaft.

Never take up end play by bringing feed advance eccentric **A4**, **Fig. 52** against rear leg bearing.

CAUTION: When feed throw-out thumb screw **O2** is loosened, be sure that feed lifting eccentric fork does not rub against the hub of feed lifting eccentric **R2**.

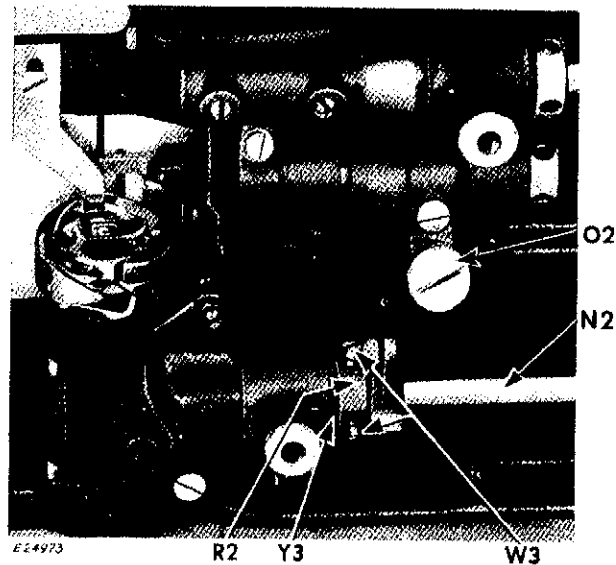

Fig. 51. Rotating Hook Driving Shaft

TO REMOVE HOOK DRIVING SHAFT

1. Remove cover from gear case **Fig. 54**.
2. Loosen sprocket screws **C4, Fig. 52**.
3. Loosen feed eccentric screws **W3**.
4. Ease shaft to the left until lower sprocket with belt is free.
5. Continue to push shaft with a rocking spiral motion until both eccentrics are free of the shaft.
6. Pull shaft out of gear case.

TO REPLACE HOOK DRIVING SHAFT

1. Insert hook driving shaft into gear case bearing.
2. Slide shaft to the right and mount feed lifting eccentric **R2, Fig. 51** with collar adjacent to bearing **Y3**.
3. Mount feed advance eccentric with collar **A4, Fig. 52**. Collar must be set close to fork without rubbing against jaw of fork to avoid binding of machine from heat expansion.
4. Pass shaft through rear bushing **B4** and enter lower sprocket.

CAUTION: To locate eccentrics and sprocket properly refer to **Fig. 53**.

5. Repack gear case as instructed on **page 75**.
6. Replace cover on gear case and fasten with two screws.
7. Check belt on both sprockets in accordance with the instruction on timing the feed on **page 29**.

NOTE: To avoid binding at end of bushing **B4** and sprocket **J2**, due to heat expansion, see **Fig. 56**.

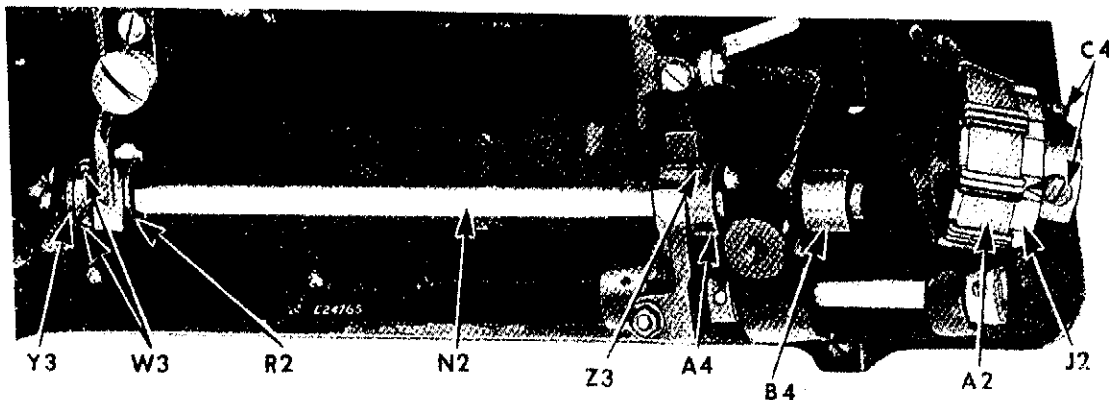

Fig. 52. Removing Sprocket and Hook Driving Shaft

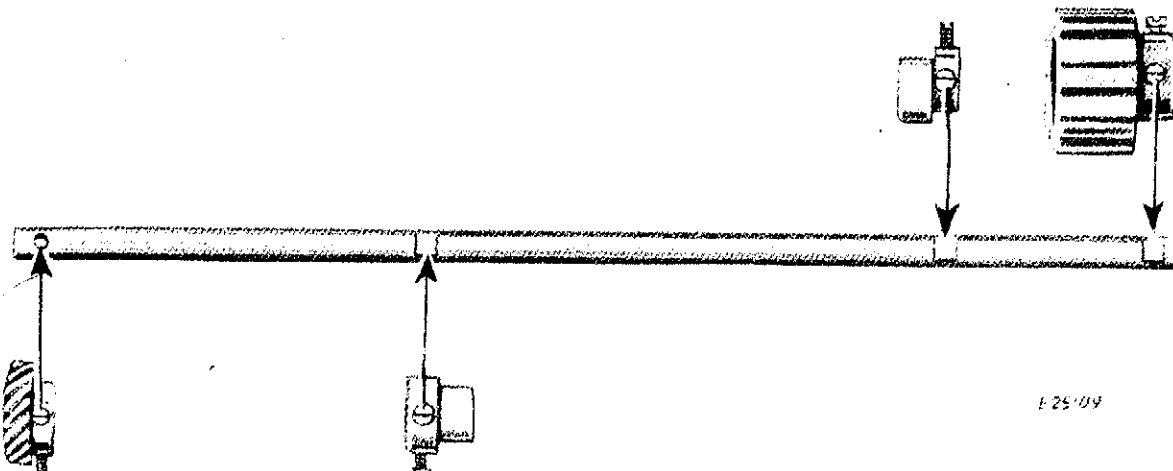

Fig. 53. Location of Gear, Eccentrics and Sprocket on Hook Driving Shaft

TO REMOVE END PLAY OR BINDING IN THE HOOK SHAFT

To remove end play or binding in the hook shaft **J4**, **Fig. 55** first loosen the two screws **X3**, push the adjusting collar **G4** sufficiently hard against the hook shaft bushing **H4**, to remove end play without binding. Securely tighten the two screws **X3**. Then loosen the screws shown at **L4** on the hub of the rotating hook **V3** and push rotating hook assembly **V3** hard against the hub of the gear **K4** on the hook shaft **J4**. Tighten one of the screws **L4** and retime the hook in relation to the needle, as described on **page 43**. Then securely tighten all screws **L4** on the hub of the rotating hook **V3**.

On some occasions a machine will bind if every trace of end shake is removed. In such a machine, to avoid binding hook shaft, collar screws **X3** should be loosened so they barely pinch and collar allowed to find its free position by running the machine. Then retighten collar screws.

NOTE: The end of hook driving shaft, toward the lower sprocket containing belt **A2**, **Fig. 52**, must be flush with the inside edge of the countersinking of the lower belt sprocket shaft hole to allow for 1/16 to 3/32 inch clearance for heat expansion as shown in **Fig. 56**.

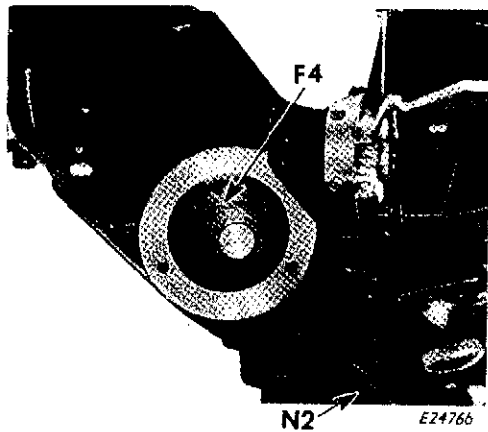

Fig. 54. Removing Hook Driving Shaft and Gear

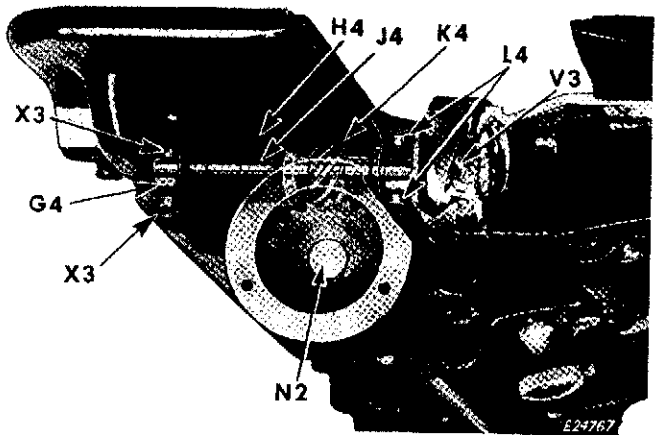

Fig. 55. Rotating Hook Shaft

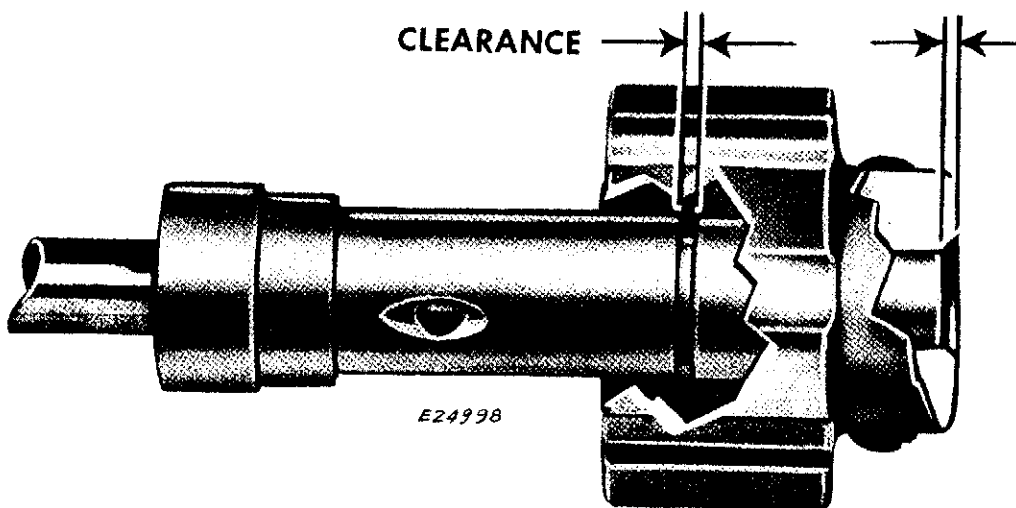

Fig. 56. Lower Sprocket Clearance for Heat Expansion

TO SET THE POSITION OF HOOK POINT TO OR FROM THE NEEDLE

The point of the rotating sewing hook must be set **behind the needle and as close as possible to the needle** without actually striking it, as shown in **Fig. 57**.

This setting is necessary to ensure uniform stitching and to prevent skipping of stitches or breaking of threads.

Before setting the hook point toward or away from the needle, remove all end play in the rotating hook shafts, as instructed on **pages 38 and 40**.

Make certain that hub of rotating hook **V3**, **Fig. 58** is firmly against the hub of gear **K4**.

To adjust the position of the hook point **V3**, loosen the screw **M4**, **Fig. 58** and move the entire hook shaft assembly toward or away from the needle, as required. Then securely tighten set screw **M4**.

When it is found impossible to properly locate the hook point in relation to the needle by either of the methods described above, the following conditions may exist:

The needle or needle bar may be bent. (Replace.)

The needle seat in the needle bar may be burred. (Replace.)

The hook point may be damaged. (Replace.)

The needle may be improperly seated. (Reset.)

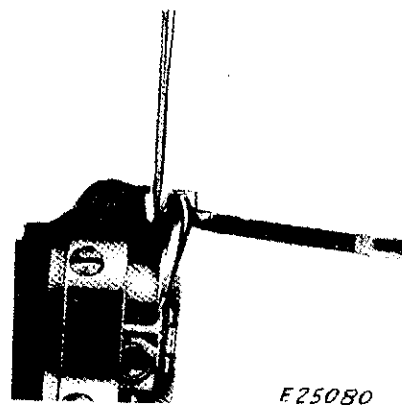

Fig. 57. Showing Relationship Between Rotating Hook Point and Needle

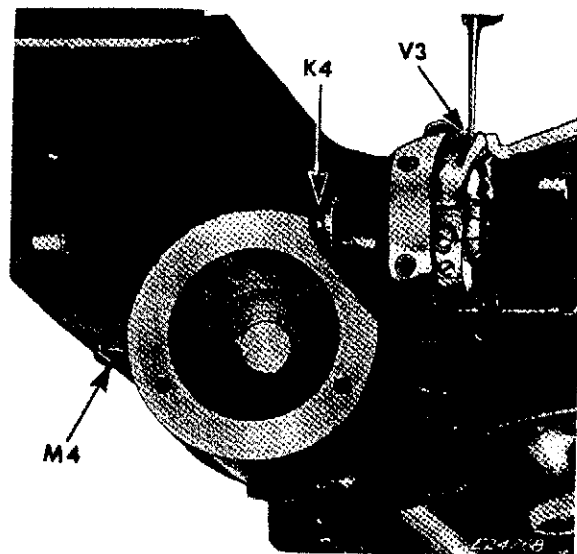

Fig. 58. Adjusting Position of Hook to or from the Needle

ADJUSTMENT FOR THREAD CLEARANCE BETWEEN POSITION FINGER AND BOBBIN CASE BASE

The thread clearance between the position finger **O4** and the bobbin case base **P4**, **Fig. 59** must be set at approximately .020 inch, so that there is free passage for the upper and under threads while the loop of needle thread is being passed around the bobbin case. There may be a tolerance of .002 inch deviation in either direction from approximately .020 thread clearance. There should also be sufficient "checking" of the bobbin thread at the completion of each stitch.

To check thread clearance, use feeler gauge No. G34203, as shown in **Fig. 59**.

If bobbin case shows a weaving motion, it may be necessary to increase lid space to .022 inch.

To adjust the position finger for proper clearance, loosen the screw **N4** and move the finger toward the front or rear, as required, then securely tighten screw **N4**.



Fig. 59. Adjusting Position Finger

TO SET THE NEEDLE BAR HEIGHT INDICATOR

To set the needle bar height indicator, **Q4**, **Fig. 60**, turn the hand wheel over toward the operator until the needle bar is at its lowest position. Loosen screw **R4** and move indicator **Q4** up or down, as required, so that it corresponds with the upper timing mark **T4**. Then securely tighten screw **R4**.

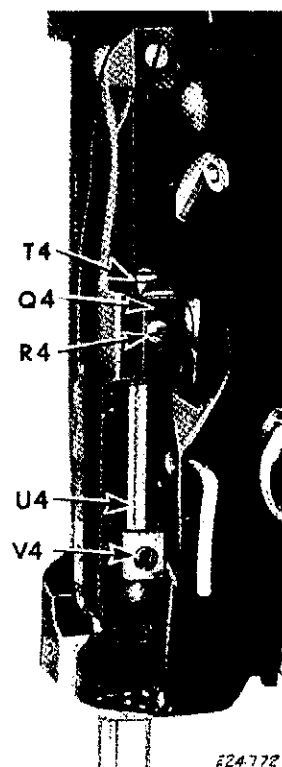

Fig. 60. Upper Timing Mark on Needle Bar

TO TIME THE ROTATING HOOK IN RELATION TO THE MOVEMENT OF THE NEEDLE

SEQUENCE OF ADJUSTMENTS TO BE VERIFIED BEFORE TIMING HOOK

1. Set Bight Controls in **CENTRAL NEEDLE POSITION**.
2. Make sure needle is not bent.
3. Make sure needle does not vibrate in "Zero" position.
4. Be sure disc follower bracket follows periphery of disc—that entire needle vibrating mechanism is not sticking or binding.
5. Check for floating front arm shaft bushing.
6. Test arm shaft for binding or end play.
7. Make sure pendulum timing is correct.
8. Check pendulum (needle) setting—provide more needle clearance at right needle position. Test with straight needle throat plate for correct centering of needle.
9. Test for end play or bind in hook shaft.
10. Check feed time.
11. Test for end play or bind in hook driving shaft.
12. Check for looseness of gear and sprocket on hook driving shaft.
13. Set correct hook and needle relationship.
14. Provide correct amount of thread clearance between bobbin case holder and position finger.

To time the rotating hook in relation to the movement of the needle, set the needle bar height indicator **Q4**, **Fig. 60** as instructed on **page 42** and set the machine for **straight stitching at central position**. Then turn hand wheel over toward the operator until the needle bar, reaching its lowest point, rises approximately $\frac{3}{32}$ inch to the point where the needle bar height indicator **Q4** corresponds with the lower **timing mark P4**, as shown in **Fig. 61**.

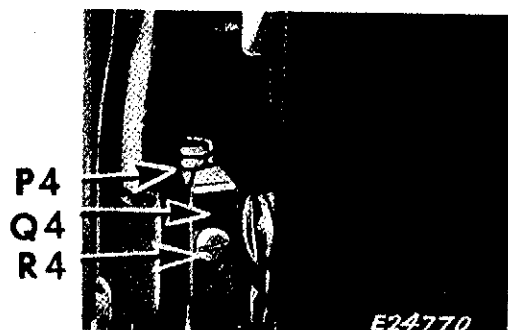

Fig. 61. Lower Timing Mark on Needle Bar

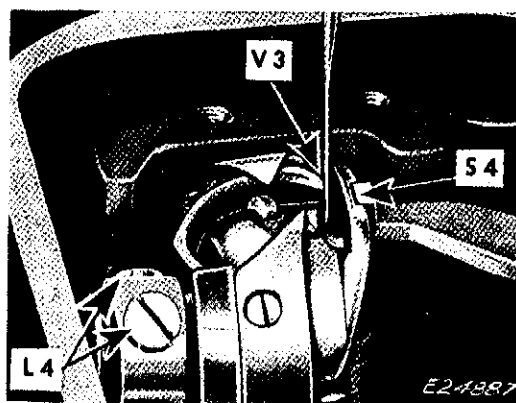

Fig. 62. Timing the Hook

At this setting the point of the hook **V3**, **Fig. 62** must be at the center of the needle.

To time the hook loosen all screws **L4**, **Fig. 62** and turn the hook as required. Maintaining this relationship, push the hook hub firmly against the hub of the gear on the hook shaft, as instructed on **page 41**, and securely tighten all screws **L4**.

Recheck timing at least 8 times.

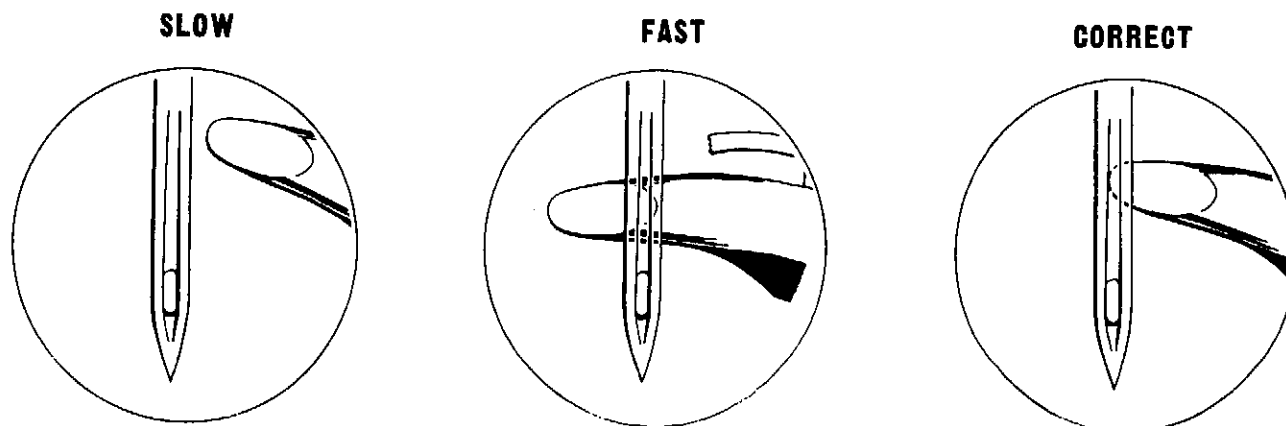

Fig. 63. Timing the Hook at Central Position

TO SET NEEDLE BAR HEIGHT WITHOUT GAUGE

After timing the rotating hook as instructed on **page 43**, set the machine at **straight stitching in left needle position**.

Turn hand wheel over toward the operator until the point of the hook **V3** is at the **center** of the needle, as shown in **Figs. 62 and 63**.

At this position, the top of the needle eye should be up to $\frac{1}{64}$ inch **below** bottom of hook point as shown in **Fig. 64**.

To adjust the height of the needle bar, loosen set screw **V4**, **Fig. 66** and raise or lower needle bar **U4**, as required. Then securely tighten screw **V4**.

Check the setting of the needle bar height indicator **Q4**, **Fig. 66** and reset, if necessary, as instructed on **page 42**.

NOTE: If difficulty, such as skipping of stitches, is experienced when sewing on sheer synthetic fabrics or rubberized materials at left or right positions of needle, set machine for **straight stitching** and turn the hand wheel over toward operator until the point of the hook is at the center of the needle. At left needle position, the bottom of hook point must be up to $\frac{1}{64}$ inch above the **top** of the needle eye. Recheck this adjustment for sewing qualities.

CAUTION: Check for radial alignment or squareness of needle bar for twin needles when using all purpose throat plate and presser foot. Twin needles will break if needle bar is not set squarely with respect to hook. See note on **page 45** to set alignment with gauges.

LEFT NEEDLE POSITION

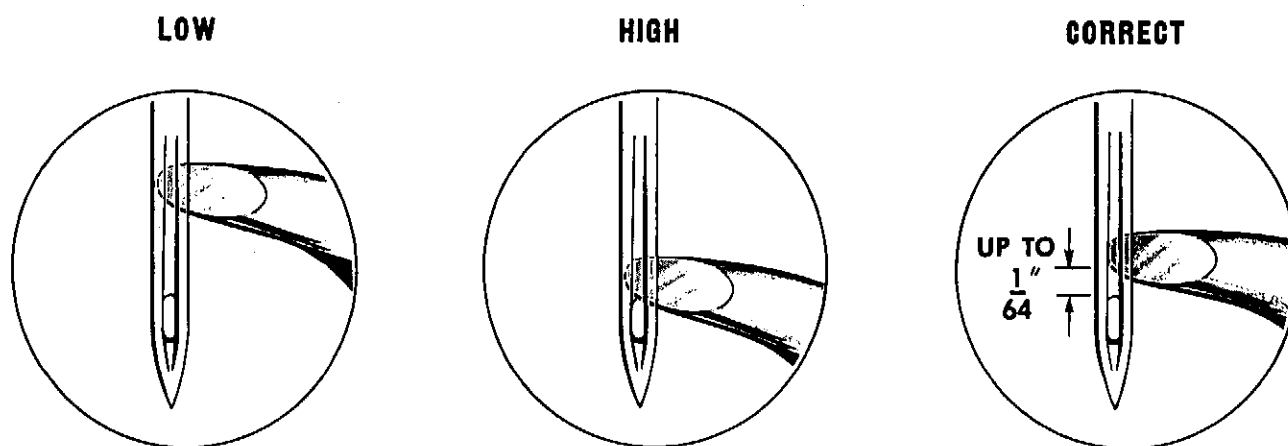

Fig. 64. Needle Bar Height at Left Needle Position

TO SET NEEDLE BAR HEIGHT WITH GAUGE

1. Set machine at straight stitching in central position and remove presser foot and needle.
2. Replace throat plate with throat plate gauge No. G34200 as illustrated in **Fig. 65**.
3. Insert needle bar height gauge No. G34201 into needle bar (similar to setting a needle) with flat side toward the rear.
4. Remove face plate.
5. Loosen set screw **V4**, **Fig. 66**.
6. Rotate hand wheel until needle bar connecting link is at its lowest position.
7. Lower needle bar **U4** until tongue of needle bar height gauge freely enters throat plate slot and the shoulder portion is firmly seated on top surface of throat plate gauge.
8. Securely tighten screw **V4**.
9. Then loosen screw **R4**, **Fig. 66** to reset needle bar height indicator. Move indicator **Q4** up or down until it corresponds with upper timing mark **T4**. Securely tighten screw **R4**.
10. Replace height setting gauge with needle.
11. Remove throat plate gauge and check timing of the rotating hook in relation to the movement of needle as instructed on **page 43**.

NOTE: Radial Alignment of needle bar is simultaneously set for twin needles when doing **steps 7** and **8**.

Inspect twin needles for damage before checking hook point and needle clearance.

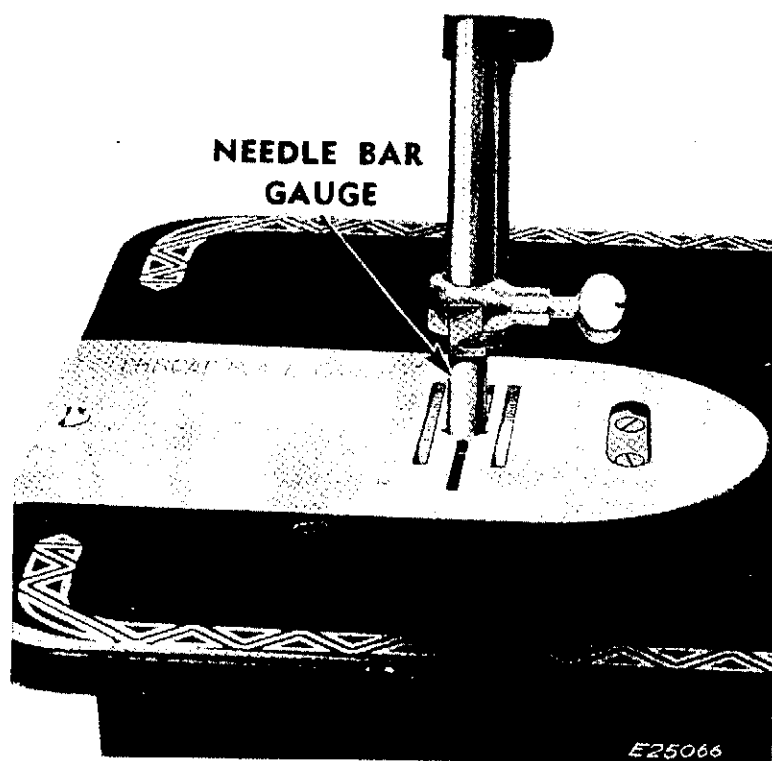

Fig. 65. Needle Bar Height and Radial Alignment

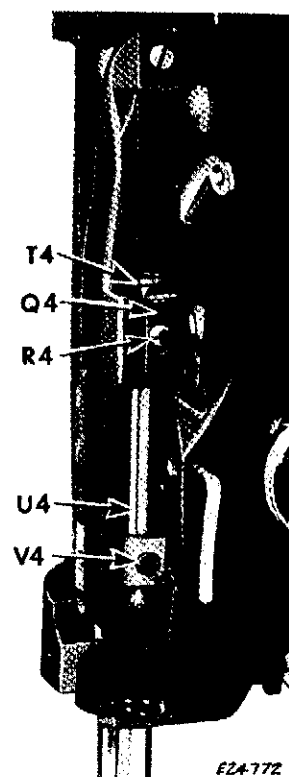

Fig. 66. Upper Timing Mark on Needle Bar

TO REMOVE AND REPLACE NEEDLE BAR

To remove needle bar, follow same procedure as instructed below for removing needle bar holder, but eliminating steps 6 and 7.

To replace needle bar, follow same procedure

as instructed on page 47 for replacing needle bar holder, but eliminating steps 2 and 3.

NOTE: It is not necessary to remove needle bar holder in order to remove or replace needle bar.

TO REMOVE NEEDLE BAR HOLDER

1. Remove needle, presser foot, throat plate and face plate.
2. Using a 1/4 inch spin type box wrench, remove nut from eccentric stud at **X4**, Fig. 67.
3. Loosen clamp screw **Y4** and withdraw needle vibrator lever fork completely from slide bushing shown in exploded view in Fig. 68.
4. Remove slide bushing from eccentric stud and remove eccentric stud from needle bar holder.
5. Care should be taken not to lose floating spring **E5**, Fig. 69 which gives sidewise tension to needle bar holder.
6. Turn hand wheel clockwise until a screwdriver can be easily inserted into slot of cap screw **M8**, Figs. 69 and 70. Then turn cap screw clockwise and remove it.
7. Remove hinge screw **C5**, Fig. 69 from supporting bracket **D5** and remove needle bar holder.
8. Loosen screw **V4** and slip needle bar **U4** from slide bushing on connecting link at **F5** and from needle bar holder.

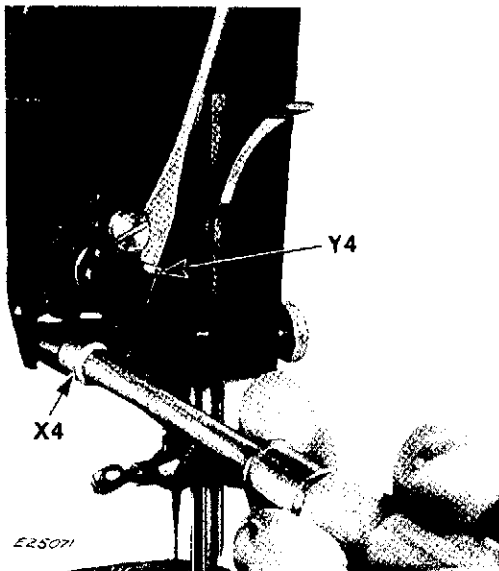

Fig. 67. Location of
Clamp Screw and Nut

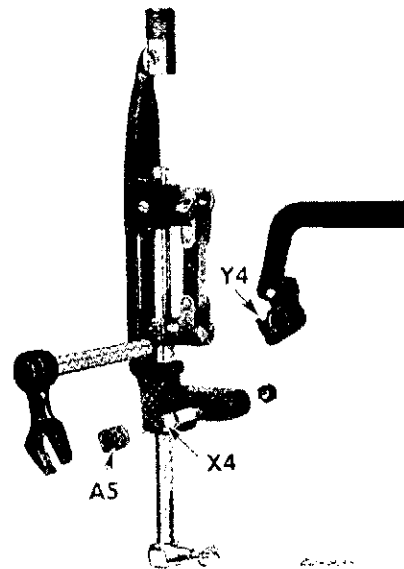

Fig. 68. Exploded View of
Needle Vibrator Fork

TO REPLACE NEEDLE BAR HOLDER

1. Before replacing needle bar holder in machine, slip needle bar into needle bar holder and through connecting link. Align thumb nut with the right angle section on needle bar holder, then temporarily tighten screw **V4**.
2. Place top of needle bar holder **B5**, **Fig. 69** into supporting bracket **D5**. Then insert hinge screw **C5** and tighten carefully to avoid stripping threads. (Use finger tip pressure.)
3. Place top of connecting link on thread take-up crank and turn cap screw **M8**, **Figs. 69 and 70** counter-clockwise and securely tighten.
4. Be sure to replace floating spring **E5** which gives sidewise tension to needle bar holder. Press bottom of holder toward hand wheel to test for free-swinging action.
5. Press holder toward hand wheel and insert eccentric stud **X4**, **Fig. 68** into needle bar holder. Then place slide bushing on eccentric stud, setting shoulder of flat sides toward needle bar holder.
6. Simultaneously place fork over the two flat sides of bushing **A5**, **Fig. 68** and insert lever end of fork into clamp at **Y4**, **Fig. 68**. Add shim of .003" between pitman crank and fork bushing. Then tighten screw **Y4** and remove shim.
7. Place nut on eccentric stud at **X4** and tighten with box wrench while holding other end in position with a screwdriver so mill cut on stud is to the top and nearly horizontal to bed but tilted slightly clockwise. See below.

Before replacing other parts, check these settings as listed:

8. Time rotating hook. See **page 43**.
9. Set needle bar at correct height. See **pages 44 and 45**.
10. Adjust zero position of needle in relation to straight stitching throat plate. See **page 52**.
11. If necessary, check and time pendulum movement of needle bar. See **pages 52 to 55 and 83**.
12. Perform needle perforation tests. See **pages 58 and 59 and 91 to 95**.

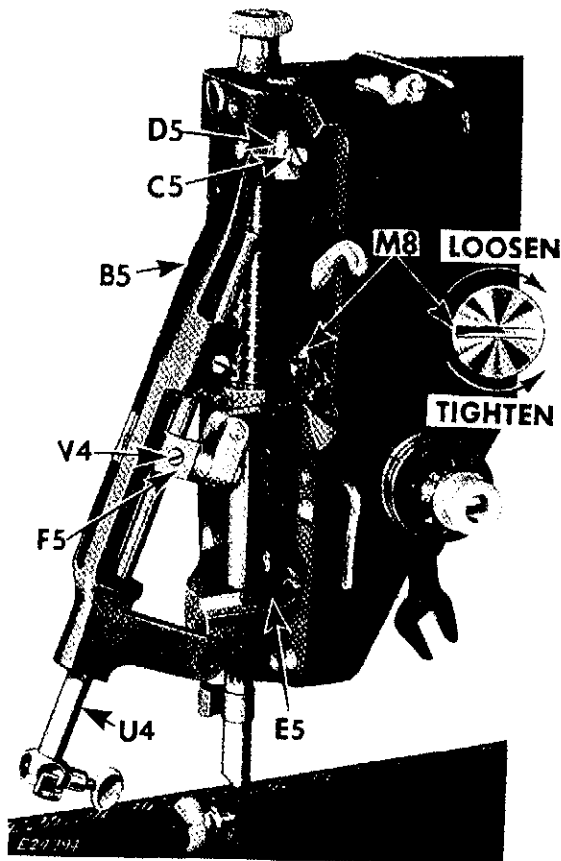

Fig. 69. Needle Bar Holder Removal and Replacement

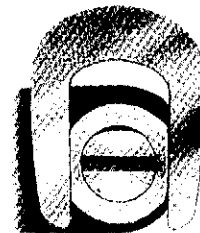

Fig. 70. Eccentric Stud X4 Showing Mill Cut

TO CHECK FOR LOOSENESS OR BINDING IN NEEDLE VIBRATING MECHANISM

Check the points indicated by arrows in **Fig. 71** and as listed below.

1. Check needle bar holder supporting bracket, needle bar holder and hinge screw.
 2. Adjust radial alignment of needle bar at set screw.
 3. Be certain needle bar is straight.
 4. Loosen connecting link cap screw by turning it clockwise. If machine is free, the difficulty may be assumed to be in connecting link.
 5. Check for pinch of needle bar connecting link hinge block adjusting screw.
 6. With pitman crank out of way, press against needle vibrator fork to note any binding.
 7. Pull fork toward you and turn needle vibrator fork bushing 180° to eliminate binding. Replace pitman crank.
 - 8-9. Hold crank against arm while raising and lowering disc follower pin. If movement is free, make same check at maximum bight.
- Reset the bight control at straight stitching neutral position. If binding occurs, the difficulty may be pitman crank **8** or the following:
10. Bent pitman.
 11. Stick in Bight Control slide and slide block.
 12. Pitman driving link, collar and nut.
 13. Check disc follower hinge pin for looseness and securely tighten screw in top of arm located over opposite end of pin.
 14. If disc follower bracket binds, loosen disc follower adjusting collar and reset.

NOTE: See **page 49** to adjust arm shaft, arm cross shaft and FASHION* discs.

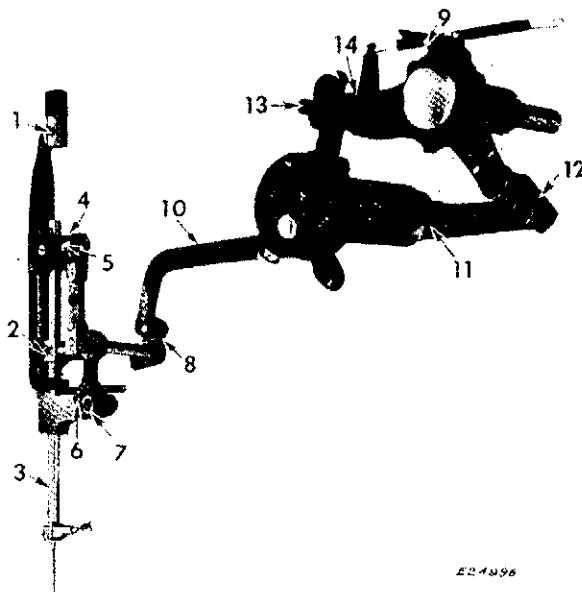

Fig. 71. Check Points—Needle Vibrating Mechanism

TO REMOVE END PLAY OR BINDING IN ARM SHAFT

To remove end play or binding in arm shaft **J7**, **Fig. 72**, loosen two screws at **K7**.

Turn FASHION disc **L7**, **Fig. 73** counter-clockwise as far as possible and apply pressure toward needle bar on collar **M7**.

Maintain the second of two screws, moving over toward operator, on flat **N7**. Then progressively tighten both screws without binding collar **M7**.

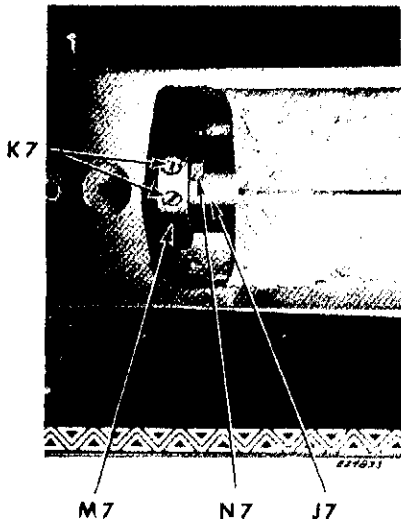

Fig. 72. Adjusting Arm Shaft

Rotate arm shaft to check for binds. If machine binds or slows down after an hour or more of use, ease both screws to allow collar to adjust itself. Repeat this procedure until machine turns freely.

NOTE: Binding can be caused by incorrect location of belt sprocket on arm shaft and insufficient clearance between arm and hand wheel bushing. See **pages 26 and 27**.

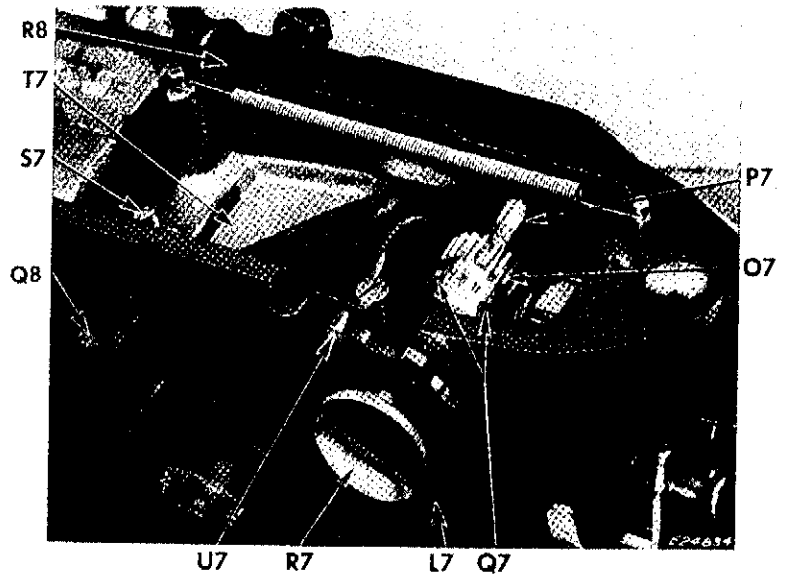

Fig. 73. Adjusting Arm Cross Shaft and FASHION Disc Stud

TO REMOVE END PLAY OR BINDING IN ARM CROSS SHAFT

To remove end play or binding in cross shaft **P7**, loosen two screws at **Q7**, **Fig. 73**.

Draw together, between forefinger and thumb, gear **O7** and nut **R7**.

Fasten gear **O7** to flat on cross shaft **P7** by means of first set screw at **Q7** when rotating gear clockwise.

Rotate arm shaft to be sure it does not bind. Then tighten each screw progressively until both screws are fastened securely.

TO ADJUST POSITION OF FASHION DISC FOLLOWER FRAME STUD IN RELATION TO FASHION DISC

To adjust the relationship of the FASHION disc follower frame stud **U7**, **Fig. 73** to the FASHION disc, loosen screw **S7** on collar.

If disc follower hinge pin **Q8** floats within the arm, it will bind machine. Locate pin **Q8** flush with front of machine arm, then securely tighten screw over hinge pin at **R8**.

Move frame **T7** to front or rear of machine until stud **U7** is flush with outside edge of FASHION disc **L7**.

Then tighten screw **S7** when frame **T7** pivots freely on hinge pin **Q8**.

TO REMOVE NEEDLE BAR PITMAN AND FASHION DISC FOLLOWER FRAME

The assembly is removed as follows:

1. Remove needle, arm top cover, back cover plate, light and motor.
2. Remove spring shown in **Fig. 73**.
3. Loosen clamp screw **Y4** and tap vibrator fork free from crank at **Z4**.
4. Loosen screws at **R8** and **S7**, **Fig. 74**. With a brass drift pin, tap hinge pin **Q8** free toward FASHION disc side of arm and remove it with adjusting collar.
5. Lift frame slightly upward with left hand and push pitman toward presser bar lifter as shown in **Fig. 75** and turn slightly to ease slide block free from bight control.
6. Lift frame upward with left hand and pivot pitman clockwise (90 degrees) with right hand until driving link is aligned with pitman and is at top of machine arm as shown in **Fig. 76**.
7. Again pivot pitman clockwise (90 degrees) while driving link is above arm, as shown in **Fig. 77**.
8. Remove assembly by lifting frame upward.

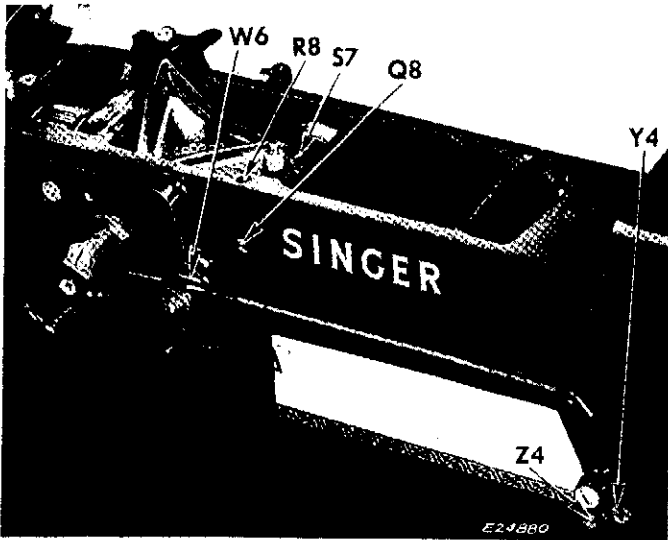

**Fig. 74. Showing Pitman
Assembly in Position**

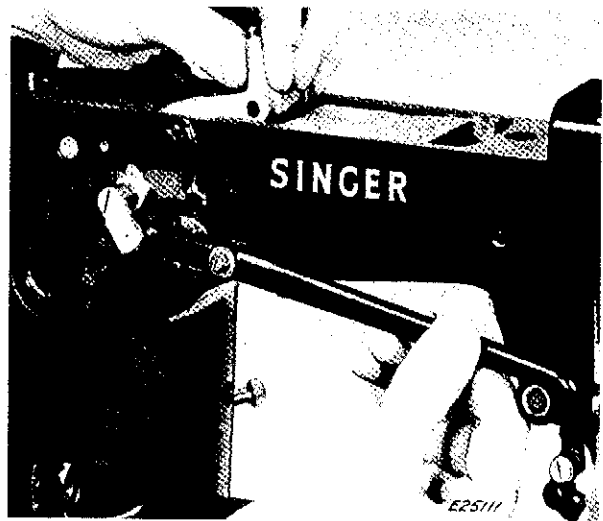

Fig. 75. Step 1

TO REPLACE NEEDLE BAR PITMAN AND FASHION DISC FOLLOWER FRAME

The assembly is replaced as follows:

1. Hold frame in left hand with driving link aligned with pitman and collar on link toward motor side of machine. Then insert pitman containing crank through top and side of machine arm as shown in **Fig. 77**.
2. Pivot pitman counter-clockwise (90 degrees) with right hand while holding frame in left hand until assembly is in position shown in **Fig. 76**.
3. Continue to lower assembly until pitman again can be pivoted counter-clockwise (90 degrees) with right hand while simultaneously guiding frame into top of arm with left hand until crank end of pitman is near presser bar lifter, as shown in **Fig. 75**.
4. Draw pitman toward hand wheel until slide block is aligned with bight mechanism, then align hole in frame with two holes in arm.
5. Guide recessed end of hinge pin into frame from FASHION disc side of arm, into beveled side of collar at **S7** and through frame until end of pin **Q8** is flush with arm. Then securely tighten screw at **R8** over pin **Q8**, **Fig. 74**.
6. Guide shaft of fork **Z4** into crank. Add a shim of .003" between pitman crank and fork bushing. Tighten clamp screw **Y4** and remove shim.
7. Move frame **T7**, **Fig. 73** to front or rear of machine until stud **U7** is flush with outside edge of FASHION disc **L7**. Securely tighten screw **S7** when frame **T7** pivots freely on hinge pin **Q8**.
8. Replace spring shown in **Fig. 73**.

NOTE: See pages 52 to 55 and 83 pertaining to pendulum settings.

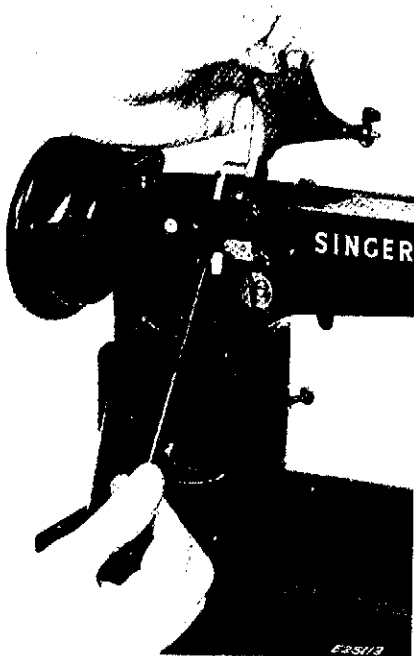

Fig. 76. Step 2

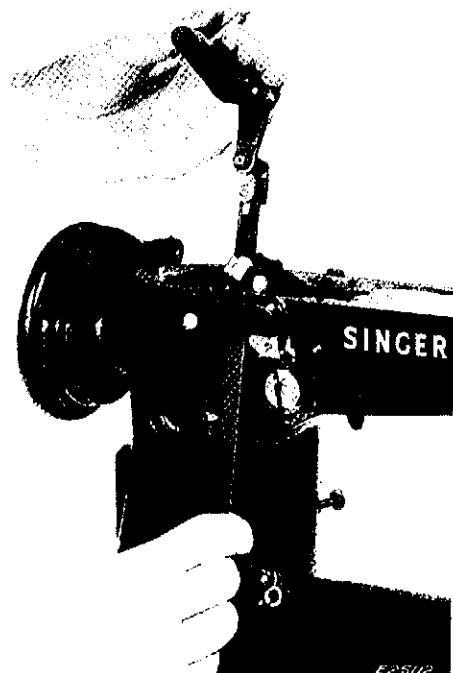

Fig. 77. Step 3

TO ADJUST PENDULUM SETTING POSITION OF NEEDLE IN RELATION TO STRAIGHT-STITCHING THROAT PLATE AND PRESSER FOOT

Machine Set for Straight Stitching at Central Position

NOTE: After coordinating the bight controls as instructed on pages 58 to 61 and 91 to 95, needle bar holder B5, Fig. 79 should be adjusted so that when the machine is set for straight stitching at the central position as shown in Figs. 78 and 202, the needle will rise and fall centrally in the small needle hole of the throat plate designed for straight stitching and midway between the long and short toes of the straight-stitching presser foot.

At no time should the needle touch the edge of the needle hole. The needle should never strike the presser foot.

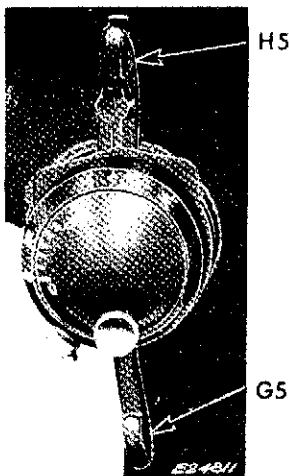

Fig. 78. Straight Stitching, Central Setting

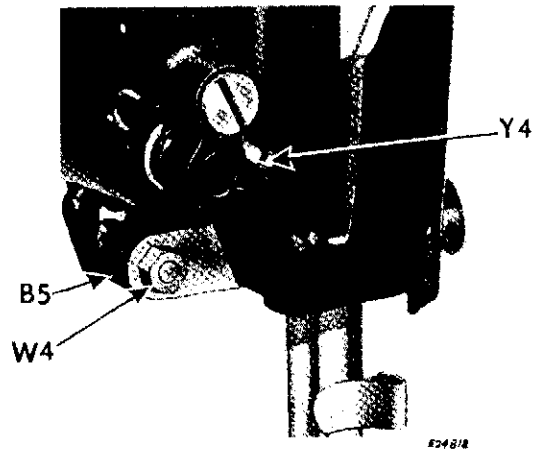

Fig. 79. Major Needle Bar Holder Adjustment on Needle Vibrator Lever

To make a major adjustment for sidewise position of needle, remove presser foot, move bight control lever G5 to zero bight and position lever H5 to its highest (central) position as shown in Fig. 78. Remove zigzag throat plate and replace with straight-stitching throat plate. Loosen clamping screw Y4, Fig. 79 and move needle bar holder as required to centralize needle sidewise in needle hole of throat plate, then securely tighten clamping screw Y4, replace straight-stitching presser foot, and recheck.

TO POSITION ECCENTRIC STUD

To correct location of eccentric stud, loosen nut W4, Fig. 79 with 1/4 inch box wrench, Serial No. 187940, while holding eccentric stud with a screwdriver as shown in Fig. 80.

Then turn eccentric stud until mill cut is to the top and nearly horizontal to bed of machine but tilted slightly clockwise.

Then securely tighten nut W4 with the wrench while simultaneously holding eccentric stud with a screwdriver to keep the stud from turning away from its true position as shown in Fig. 80.

NOTE: If pendulum is correct for straight stitching, it will be correct for zigzag stitching also.

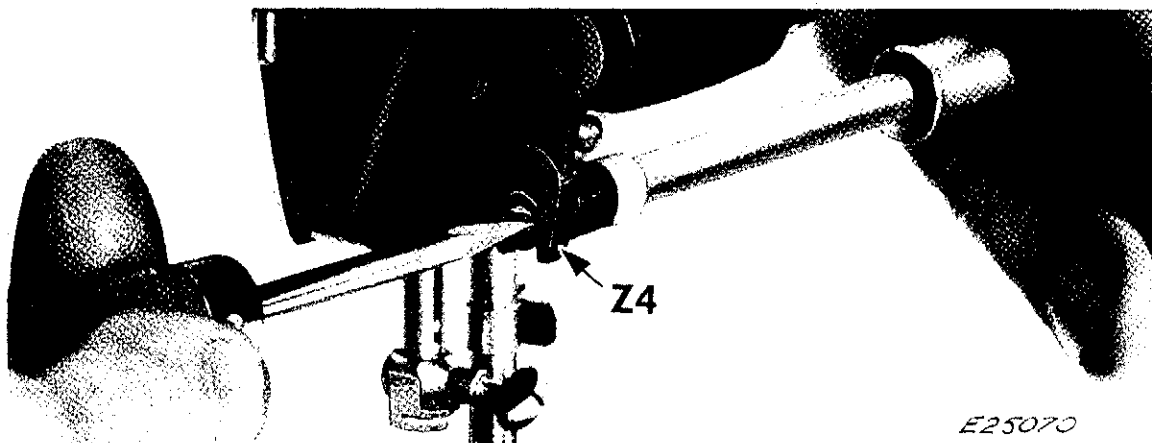

Fig. 80. Correct Location of Eccentric Stud

TIMING PENDULUM MOVEMENT OF NEEDLE BAR WITHOUT GAUGE

METHOD No. 1

Set the bight control lever **G5** at maximum bight and position lever **H5** at its highest (central) setting as shown in **Fig. 81**.

While slowly turning hand wheel over toward the operator, watch the movement of the small needle vibrator lever fork **Z4**, **Fig. 80**.

Observe the following:

1. When the fork begins to move from one side to the other, the needle should begin its pendulum movement.

2. The needle should reach the peak **J5**, **Fig. 82** of its ascent midway between the two extreme positions **K5**, **Fig. 82** of the needle.

3. When the needle vibrator lever fork **Z4** reaches the opposite end of its swing, the pendulum movement should be completed as shown in **Fig. 82**.

4. The needle should begin and end its **pendulum movement** at about the same height above the throat plate as shown in **Fig. 82**.

5. There should be no pendulum movement while the needle is moving through the material.

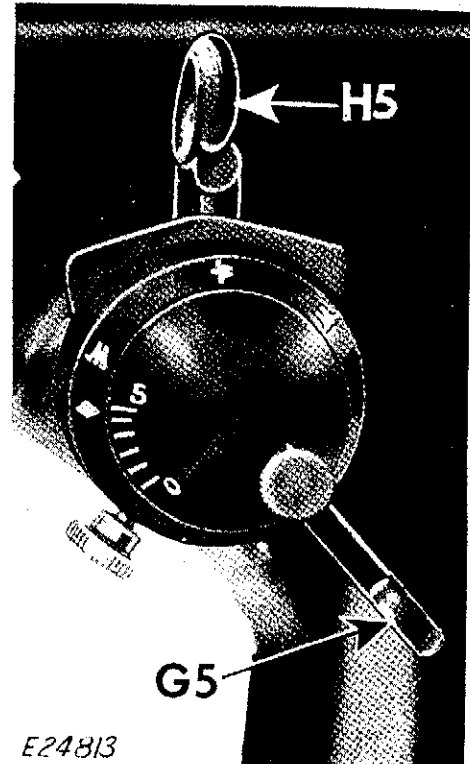

Fig. 81. Zigzag Stitching Central Setting

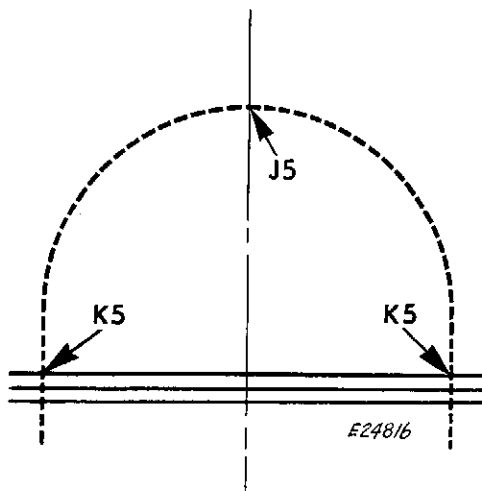

Fig. 82. Correct Path of Needle Pendulum Movement

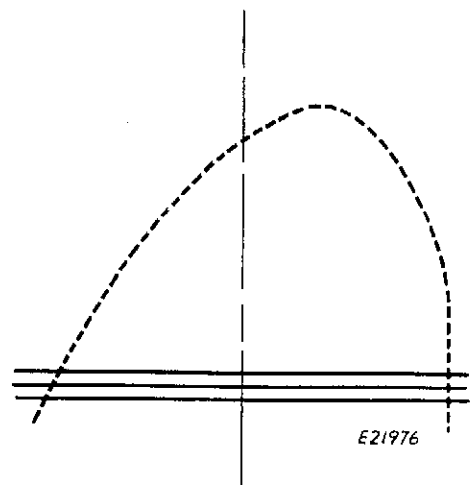

Fig. 83. Example of Incorrect Pendulum Movement

To time the pendulum movement of the needle bar, loosen two set screws **M5, Fig. 84** in the worm gear **N5, Fig. 84** in the gear box on top of the machine and free gear **N5** from arm shaft.

Rotate arm shaft by turning hand wheel over

toward the operator or away from the operator while keeping gear **N5** in place by holding a screwdriver over one of two set screws **M5, Fig. 84**. When a desired setting is obtained, tighten one of the set screws **M5** and recheck pendulum movement. If results are satisfactory, securely tighten both screws.

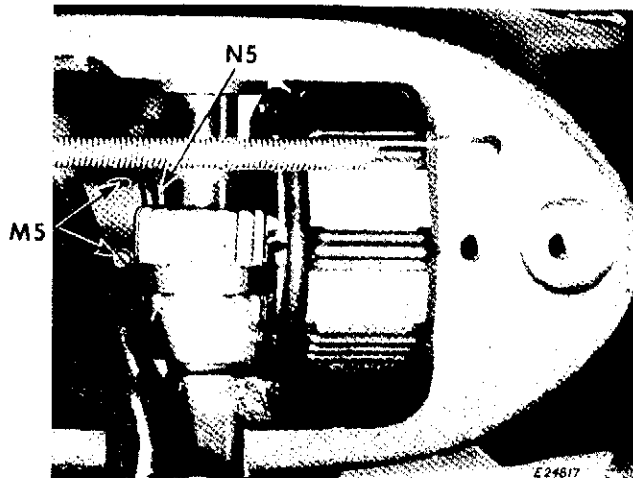

Fig. 84. Adjusting Needle Pendulum Movement

TO TIME PENDULUM MOVEMENT OF NEEDLE BAR WITHOUT GAUGE

METHOD No. 2

1. Check needle bar height as instructed on pages **44** and **45**.
2. Remove arm top cover.
3. Raise presser foot.
4. Set machine for straight stitching at central position. Use FASHION Disc #1.
5. Turn hand wheel over toward you until needle has reached its lowest point and is just beginning to rise. When needle is in this position, disc follower should be at high point on disc #1.
6. Press left index finger down on tab of follower frame while continuing to turn hand wheel slowly over toward you.
7. When follower just begins to roll off the high point of disc #1 and starts to fall into the low point of the disc, you will feel and hear a slight click in the follower frame.
8. Stop turning hand wheel at the instant the click is felt and heard. At this position the needle should have risen about $5/16''$ above the surface of the throat plate. (An easy check for this height is to note the relationship of the needle point to the bottom of the presser foot. If they are approximately at the same height— $5/16''$ —then the pendulum movement is correct.)
9. If needle is not at correct height when the click is heard, loosen set screws **M5, Fig. 84** in worm gear **N5** on arm shaft and slide gear to right or left to correct the condition.
10. When desired setting is obtained, tighten one of screws **M5** and recheck pendulum movement. If results are satisfactory, securely tighten both screws.

TO TIME PENDULUM MOVEMENT OF NEEDLE BAR WITH GAUGE

Set machine in central straight stitching position. Replace the FASHION disc on arm cross shaft with the Bight-Pendulum Gauge No. G34204.

Turn hand wheel until FASHION disc follower frame stud is seated in square slot of gauge as shown in **Fig. 85**.

Raise the FASHION disc follower frame to clear stud from square slot in gauge. Slightly rotate arm shaft by turning hand wheel until needle bar is at its lowest position.

Release FASHION disc follower frame. If the FASHION disc follower frame stud seats in the square slot of the gauge, no adjustment of the worm gear **N5**, **Fig. 84** on arm shaft is necessary.

If the FASHION disc follower frame stud does not seat in the outer slot of the gauge proceed as follows:

1. Remove needle.
2. Remove arm top cover.
3. Remove FASHION disc follower frame return spring.
4. Loosen two screws **M5**, **Fig. 84** which hold driving worm gear to arm shaft.

CAUTION: Do not loosen screws **Q7**, **Fig. 73** on arm cross shaft gear. If screws are loose, reset as instructed on **page 49**.

5. Turn hand wheel until needle bar is at its lowest position, then hold hand wheel to keep it from turning.
6. Insert finger tips into cut outs of gauge. Then without turning hand wheel nor moving needle bar from its lowest position, rotate pendulum part of gauge until FASHION disc follower frame stud falls into top slot of gauge as shown in **Fig. 85**.
7. Tighten securely one of two set screws, **M5**, **Fig. 84** on arm shaft driving worm gear.
8. Remove gauge from arm cross shaft.
9. Rotate arm shaft with hand wheel and securely tighten second screw **M5**, **Fig. 84** on gear **N5**.
10. Replace FASHION disc follower return spring.
11. Replace arm top cover.
12. Replace needle.
13. Check pendulum movement of needle bar as described on **page 53** and as shown in **Fig. 82**.

NOTE: See **page 60** to make a fine adjustment of pitman fulcrum eccentric stud if needle vibrates when all bight controls are in neutral. Also check pitman for binding.



Fig. 85. Pendulum Timing with Gauge

TO SET THE PRESSER BAR AT THE CORRECT HEIGHT

When the presser foot is raised, there should be a clearance of $5/16$ inch between the presser foot and the throat plate.

To set the presser bar at the correct height, raise the presser bar lifter **O5**, **Fig. 86** to its highest position.

Loosen the set screw **P5** and raise or lower the presser bar as required.

After locating the presser foot in relation to the needle, retighten the set screw **P5**, **Fig. 86**.

NOTE: See **page 57** for testing squareness of presser foot to feed.

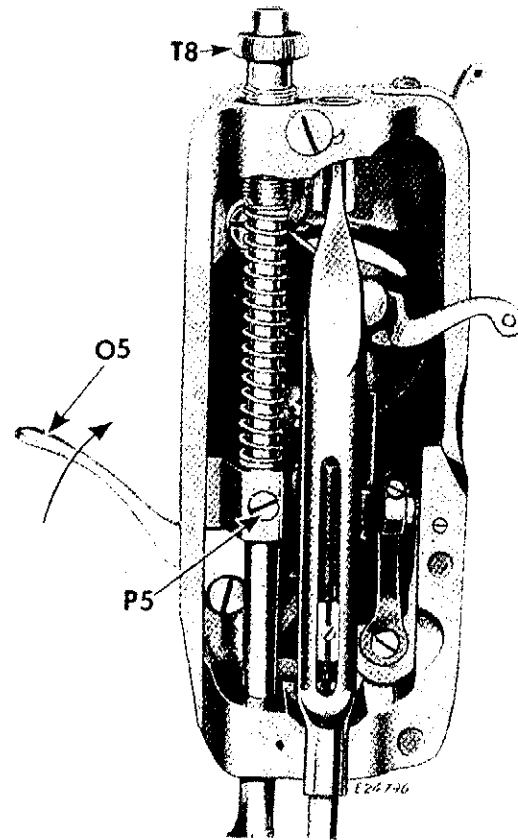

Fig. 86. Adjusting Height of Presser Bar

TO REGULATE PRESSURE ON PRESSER FOOT

The surface finish on fabrics, as well as their weight, determine amount of pressure to be applied. The glazed surface of chintz and polished cotton, the loose nap surface of satin, the deep piled surface of velvet, the delicate and broken surface of lace and brocade, all require a lighter pressure.

To set a light pressure, turn thumb screw **T8**, **Fig. 86** upward until fabric moves easily under presser foot without slipping and without showing feed marks.

Heavy, spongy fabrics like toweling, chenille, coating, etc., require heavier pressure.

To set a heavy pressure, turn thumb screw **T8** downward until the fabric moves easily and the seam edges are carried evenly by the foot and the feed.

The pressure should be heavy enough to prevent side creepage of material and to obtain uniform stitch length, yet light enough to carry the material without marking. The heavier the material, the more pressure is required.

TESTS FOR SQUARENESS OF PRESSER FOOT TO FEED

Figs. 87 through 90 illustrate tissue paper tests which are necessary when inspecting presser foot and feed dog for faulty operation and poor alignment.

Tissue Paper For Testing Purposes may be obtained from The Singer Manufacturing Company by requesting Form No. 645. This paper is standard for testing all sewing machines.

Tissue paper tests are made while the feed dog and take-up lever are at their highest positions and the presser foot is lowered. At these settings, if the feed dog and presser foot are in correct alignment,

material to feed more easily when beginning to sew at very edge of material.

If tissue paper can be passed over the needle hole from the front, as shown in **Fig. 87**, the result will be a poor feeding of material when sewing.

If tissue paper can be passed over teeth from the rear, as shown in **Fig. 88**, the material will gather when sewing.

If tissue paper can be passed over teeth on left side, as shown in **Fig. 89**, the material will creep to the left when sewing.

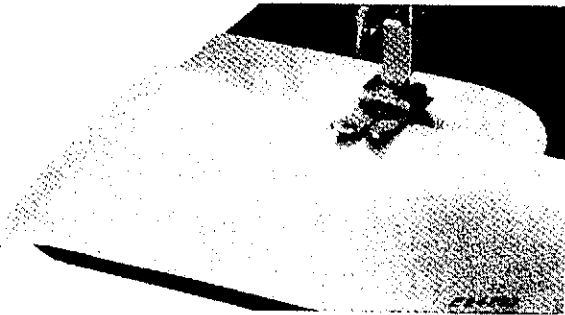

Fig. 87. Paper Passed Needle Hole

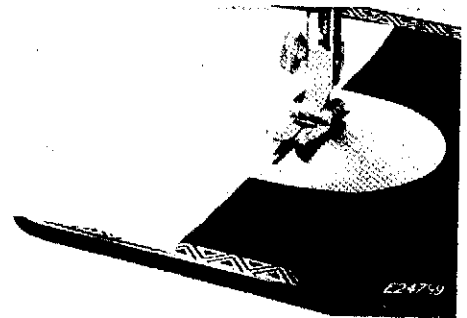

Fig. 89. Paper Passed Teeth on Left Side

the tissue paper cannot pass beyond the first four pairs of front teeth. These four pairs of teeth have been made lower than the rest of the teeth to permit

If tissue paper can be passed over teeth on right side, as shown in **Fig. 90**, the material will creep to the right when sewing.

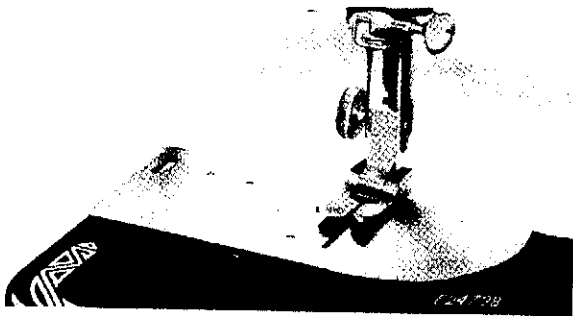

Fig. 88. Paper Passed Rear Teeth

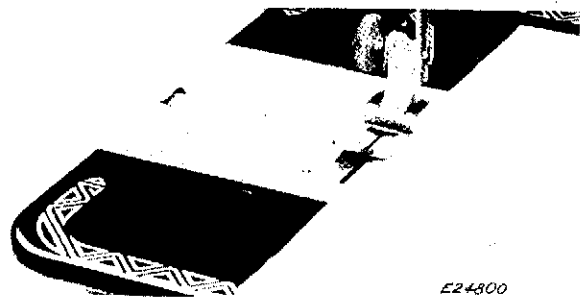

Fig. 90. Paper Passed Teeth on Right Side

NEEDLE-PERFORATION TESTS

The adjustment of the bight control mechanism discussed on the following pages, should be checked by means of needle-perforation tests.

To prepare for these tests, remove the presser foot; tilt machine back on hinges, and turn feed throw-out thumb screw **O2**, **Fig. 91** over to left as far as it will go, dropping feed dog mechanism **Q2**, **Fig. 91**.

CAUTION: Do not force thumb screw to avoid loss of retaining clip.

To make a needle-perforation test, place a sheet of notepaper over the throat plate. Turn hand wheel forward until needle makes a slight perforation in the paper, then backward until another perforation is made. Repeat this operation for each test required, as instructed on the following pages.

To insure an accurate reading during these tests, the perforations should be as small as possible—the needle barely pricking the paper at each test position. Use a Size #9 needle.

It is important to the accuracy of these tests that the paper should be held securely upon the throat plate and under the needle in such a way that it will not move in any direction throughout each complete test.

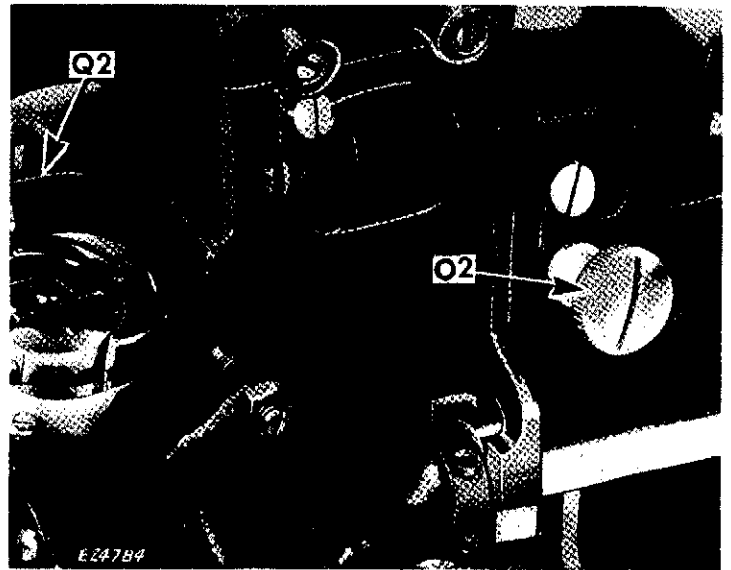

Fig. 91. Dropping the Feed

If the needle strikes the throat plate during these tests, the small vibrating needle lever and needle bar holder may be in need of adjustment, as instructed on **page 52**.

NOTE: See **page 59** to perform needle perforation tests and to check for needle vibration.

See **page 60** to eliminate needle vibration if tests on **page 59** require it.

**Set Right Controls
In Order Listed**

**Correct
Perforations**

**Incorrect
Perforations**

Conclusion

Test #1—Straight stitch at central position. **Fig. 110.**

Test #2—Straight stitch at left position. **Fig. 113.**

Test #3—Straight stitch at right position. **Fig. 115.**

Test #4—Maximum zigzag stitch at central, **Fig. 119**, coordinated with Test #1.

Test #5—Maximum zigzag stitch at left position, **Fig. 121**, coordinated with Test #2.

Test #6—Maximum zigzag stitch at right position, **Fig. 122**, coordinated with Test #3.

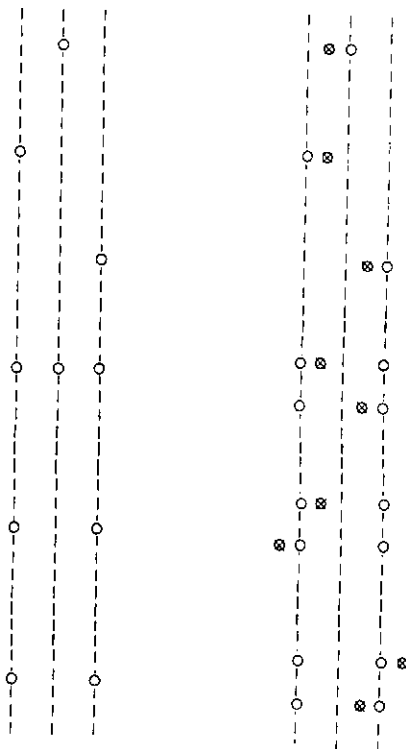

Puncture must not be at X but coincide at central needle position.

Puncture must not be at X but coincide at left needle position.

Puncture must not be at X but coincide at right needle position.

Puncture must not be at X but at central position.

Puncture must not be at X but coincide at left needle position.

Puncture must not be at X but coincide at right needle position.

NOTE: If needle vibrates, perforations can be corrected by eliminating needle vibration as instructed on **page 60**.

Figs. 92 and 93 illustrate correct perforations by lines of stitching for Test #4. **Figs. 94 and 95** show incorrect lines of stitching for Test #4.

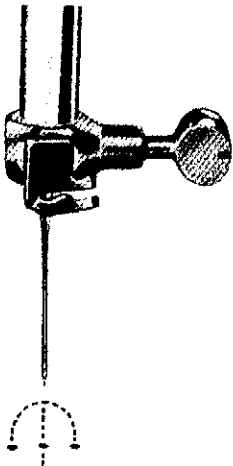

Fig. 92. Needle Perforation Test



Fig. 93

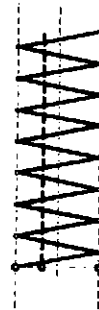

Fig. 94



Fig. 95

TO ELIMINATE NEEDLE VIBRATION WITH GAUGE

With all bight controls in neutral, there must not be any needle vibration (side movement) in any of the straight stitching positions of the needle.

IF NEEDLE VIBRATES

1. Replace FASHION disc with Bight Gauge No. G34204.
2. Rotate hand wheel so that cross shaft pin rides top of gauge above the word "BIGHT."
3. Set needle bar at its lowest position.

STEP I

Part 1—With arm top cover in place, raise and lower FASHION disc follower frame no more than 1/8" as shown in Fig. 97.

If there is no needle vibration, omit **part 2** of **Step I** and make test described in **Step II**.

Part 2—If there is vibration in needle bar, due to the raising and lowering of the FASHION disc follower frame, then loosen both bight control set screws **X5**, Fig. 131, page 67. Slowly rock bight control clockwise or counter-clockwise while repeatedly raising and lowering FASHION disc follower frame until movement of the needle bar stops. Securely tighten both bight control set screws.



Fig. 97. Vibration Gauge Test With Controls at Neutral

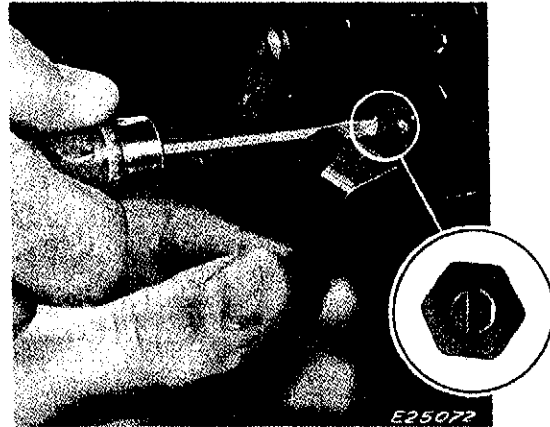

Fig. 96. Adjusting Eccentric Stud

STEP II--CENTRALIZING THE PITMAN FULCRUM ECCENTRIC STUD

Repeat check for needle bar movement by swinging bight control lever from zero to full bight. Should there still be a slight amount of movement in needle bar, after **Step I**, it will then be necessary to make a fine adjustment of the pitman eccentric stud. Generally, the pitman fulcrum stud screwdriver slot is nearly perpendicular to the bed with the mill cut (bevel) of fulcrum stud always toward the head of machine as shown in Fig. 96. Loosen the nut locking the pitman fulcrum stud. Turn stud (clockwise or counter-clockwise) until needle bar vibration is eliminated while continually moving bight control lever from zero to full bight as shown in Fig. 98. Hold fulcrum stud in position and carefully tighten nut so as not to disturb the setting of the pitman fulcrum stud. Should the needle bar continue to vibrate, it is recommended that the bight control be removed and rechecked for proper alignment.



Fig. 98. Vibration Gauge Test While Swinging Lever to Full Bight

COORDINATING EXTREME LEFT- AND RIGHT-NEEDLE POSITIONS

The range of movement of the position lever **H5**, **Fig. 103** should be regulated so that the extreme left- and right-hand positions of the needle during straight

stitching is determined by the position of the two screws **Q5** and **S8**, **Fig. 103**.



Fig. 99. Needle-Perforation test

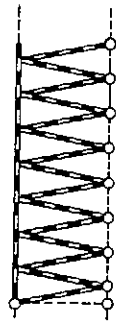

Fig. 100. Lines of Stitching



Fig. 101. Needle-Perforation Test

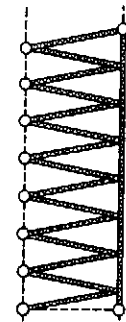

Fig. 102. Lines of Stitching

LEFT-HAND SETTING

RIGHT-HAND SETTING

(Straight Stitching and Maximum Zigzag Stitching)

stitching coincide respectively with the extreme left- and right-hand positions of the needle at maximum bight during zigzag stitching as shown below in **Figs. 99, 100, 101** and **102**.

Should left or right needle positions exceed or fall short of span of the bight, turn stop screws **Q5** and **S8** inward or outward to coordinate the maximum bight with the extreme left and right needle positions.

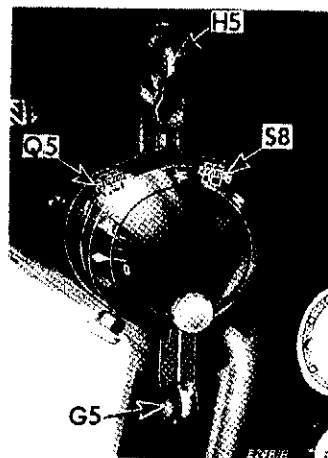

Fig. 103. Position Lever Stop Screws

BIGHT

The width of the zigzag movement of the needle, while stitching, is termed the **BIGHT**. See **Figs. 104 to 109**. The mechanism, in the upright part of the machine arm, which controls the width and the position of the bight is called the **BIGHT CONTROL**.

The width of bight is sometimes referred to as the "swing of the needle" or the "needle vibration."

The sidewise position of the needle during straight or zigzag stitching is determined by the setting of the **NEEDLE BAR POSITION LEVER H5, Fig. 110**.

The width of the bight is determined by the setting of the **BIGHT CONTROL LEVER G5, Fig. 110**.

STITCHING AT VARIOUS WIDTHS OF BIGHT

SETTINGS ON

BIGHT CONTROL SCALE	"0"	#1	#2	#3	#4	#5
APPROXIMATE INCH	0	3/64"	5/64"	1/8"	5/32"	3/16"

SAMPLE OF STITCHING

(Actual Size)

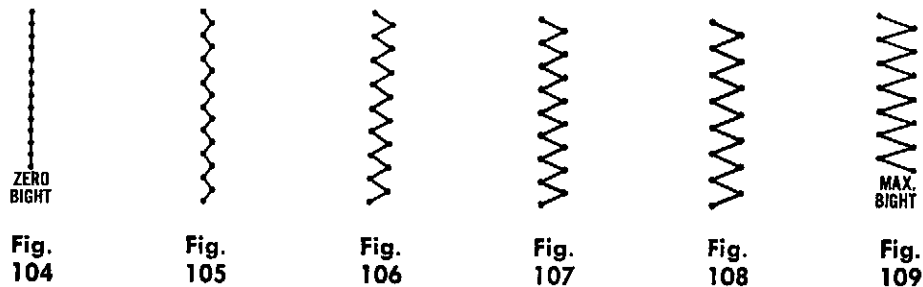

When the bight lever **G5, Fig. 110** is at its **lowest possible position**, the machine is set at **ZERO**

BIGHT and should produce **straight stitching** only as shown in **Fig. 104**.

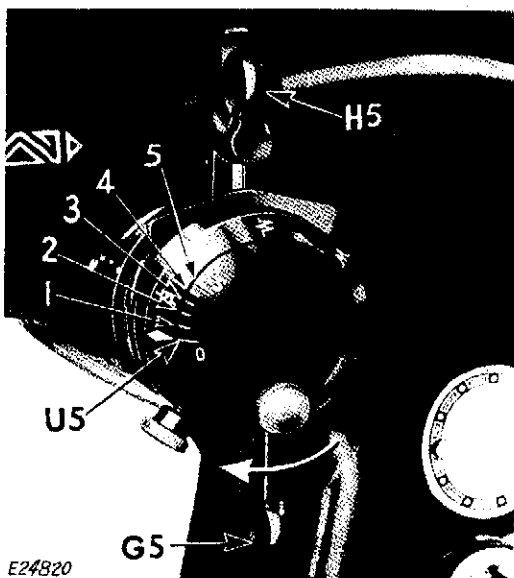

Fig. 110. Bight Controls At Central Position (Straight Stitching)

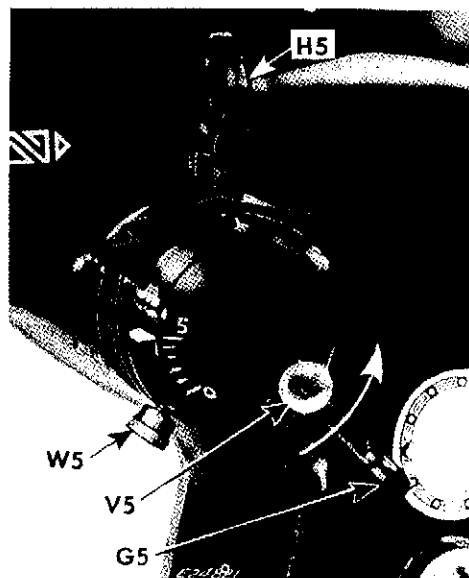

Fig. 111. Bight Controls at Central Position (Zigzag Stitching)

When the bight lever **G5** is at its **highest** (extreme right) position, as shown in **Fig. 111**, the machine is set at **MAXIMUM BIGHT** and should perform zigzag stitching approximately 3/16 inch wide, as shown in **Fig. 109**.

The bight lever **G5** may also be set at #1, #2, #3 or #4 positions on the **BIGHT CONTROL SCALE U5, Fig. 110**, thus setting the width of bight to one of those shown in **Figs. 105, 106, 107** or **108** respectively.

BIGHT LIMIT SCREWS

Thumb screw **V5, Fig. 111** acts as a **stop** which limits **maximum** bight. Thumb screw **W5, Fig. 111** acts as an intermediate stop for a desired **minimum** bight, which can be passed over to zero bight if desired.

For example: To limit zigzag stitching between #1 and #4 positions on dial, set bight lever **G5** at #4, loosen screw **V5** and retighten it. Then set bight lever **G5** at #1 on dial, loosen screw **W5** and move it up or down to a point where you can feel it engage the in-

termediate stop; then tighten screw **W5**. The bight lever is now set to limit the maximum bight at #4 and minimum bight at #1. The minimum bight, determined by the intermediate stop can be felt and passed to "O" when desired.

Other limits such as #2 to #3 or #1 to #3 positions, can be set in the same manner.

BIGHT LIMIT SCREW SETTINGS (Straight Stitch or Maximum Zigzag)

When bight limit screws **V5** and **W5** are not required, loosen them both. Set bight lever at #5 as shown in **Fig. 111** and tighten screw **V5**. For straight stitching, set bight lever at zero. Move screw **W5** until notch is engaged and securely tighten screw **W5**. When a definite bight is desired, screw **W5** must engage the notch at that bight and be tightened. When free movement of the bight lever is required between zero and maximum bight, the screw **W5** should be moved down as far as it will go and then tightened.

Screws **V5** and **W5** should **always be tightened** when machine is in use.

VARIETIES OF STITCHING AND SUMMARY OF CONTROLS OBTAINABLE FROM BIGHT CONTROL MECHANISM

NO. 1 STRAIGHT STITCH, CENTRAL NEEDLE POSITION

CAUTION: A machine equipped with straight stitching throat plate and presser foot **must always be set for straight stitch at central position.**

SETTING: Bight lever **G5** at lowest point (Zero Bight) and position lever **H5** at highest point (CENTRAL POSITION) as shown in **Fig. 110**.

STITCHING: Straight stitching obtained **midway between left and right hand positions of straight sewing**, as shown in **Fig. 112**.

NOTE: The straight sewing positions shown on this page require the use of the slotted throat plate and slotted presser foot to accommodate the swing of the needle.

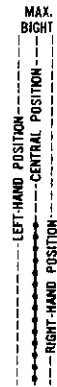

Fig. 112

NO. 2 STRAIGHT STITCH, LEFT NEEDLE POSITION

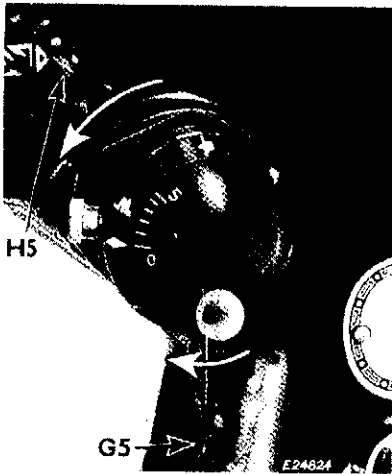

Fig. 113. Left Needle Position (Straight Stitching)

SETTING: Bight lever **G5** at ZERO and position lever **H5** over to the left as far as possible, as shown in **Fig. 113**.

STITCHING: Straight stitching at the **extreme left-hand** position of the needle, as shown in **Fig. 114**.



Fig. 114

NO. 3 STRAIGHT STITCH, RIGHT NEEDLE POSITION

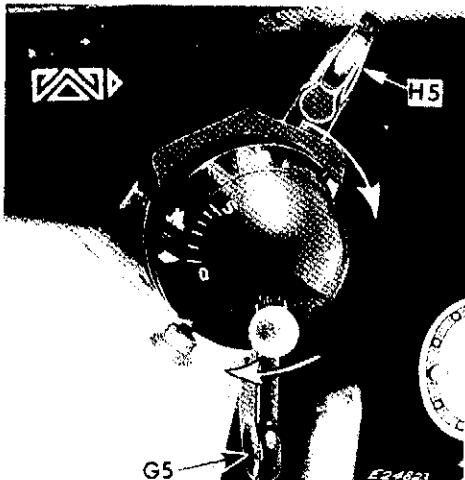

Fig. 115. Right Needle Position (Straight Stitching)

SETTING: Bight lever **G5** at ZERO and position lever **H5** over to the right as far as possible, as shown in **Fig. 115**.

STITCHING: Straight stitching at the **extreme right-hand** position of the needle, as shown in **Fig. 116**.



Fig. 116

NO. 4 STRAIGHT STITCH INTERMEDIATE POSITIONS



Fig. 117. Various Positions (Straight Stitching)

SETTING: Bight lever **G5** at ZERO and position lever **H5** at any one of the settings between the extreme left and right positions. See **Fig. 117.**

STITCHING: Straight Stitching on one or more of the countless lines between the extreme left and right needle positions. See **Fig. 118.**

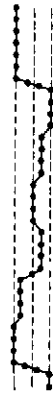

Fig. 118

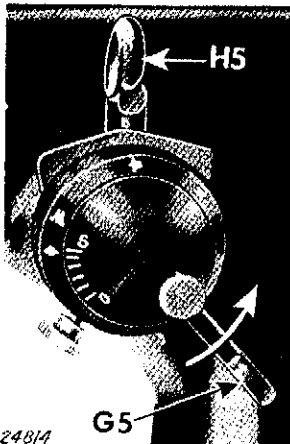

Fig. 119. Central Needle Position (Zigzag)

NO. 5 MAXIMUM ZIGZAG STITCH, CENTRAL NEEDLE POSITION

SETTING: Bight lever **G5** at #5 position and position lever **H5** at Central point, as shown in **Fig. 119.**

STITCHING: Zigzag stitching produced at the maximum width possible, the needle swinging equally to the extreme left and to the extreme right of the central needle position, as shown in **Fig. 120.**

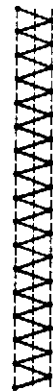

Fig. 120 Maximum Zigzag Stitch

NO. 6 MAXIMUM ZIGZAG STITCH, LEFT NEEDLE POSITION

SETTING: Bight lever **G5** at #5 position and position lever **H5** over to the extreme left, as shown in **Fig. 121.**

STITCHING: Zigzag stitching produced at the maximum width possible, as shown in **Fig. 120.**

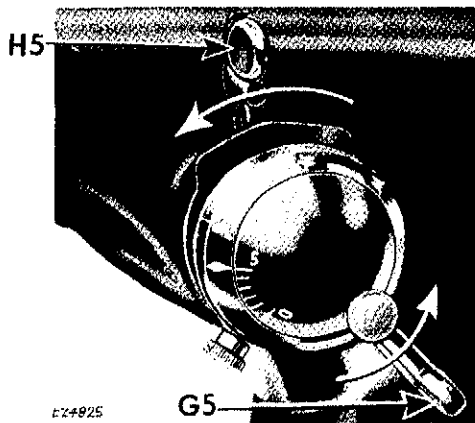

Fig. 121. Left Needle Position (Zigzag Stitching)

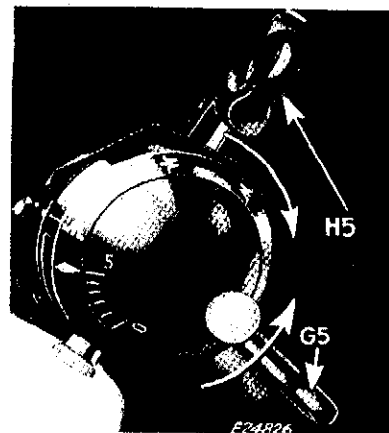

Fig. 122. Right Needle Position (Zigzag Stitching)

NO. 7 MAXIMUM ZIGZAG STITCH, RIGHT NEEDLE POSITION

SETTING: Bight lever **G5** at #5 position and position lever **H5** over to extreme right, as shown in **Fig. 122.**

STITCHING: Zigzag stitching produced at the maximum width possible, as shown in **Fig. 120.**

NOTE: When the bight lever **G5** is set at maximum bight, as described in last three types of stitching the appearance of the stitching should remain the same, regardless of the setting of position lever, see **Fig. 120.**

NO. 8 ZIGZAG STITCH, VARIOUS WIDTHS, CENTRAL NEEDLE POSITION



Fig. 123. Central Needle Position (Various Widths of Bight)

SETTING: Bight lever **G5** at any desired setting between "0" and #5 positions and position lever **H5** in central position, as shown in **Fig. 123**.

STITCHING: Zigzag stitching produced at width desired up to maximum bight—the needle swinging equally to the right and to the left of the central position. Variations of this stitching are shown in **Fig. 124**.



Fig. 124

NO. 9 ZIGZAG STITCH, VARIOUS WIDTHS, LEFT NEEDLE POSITION

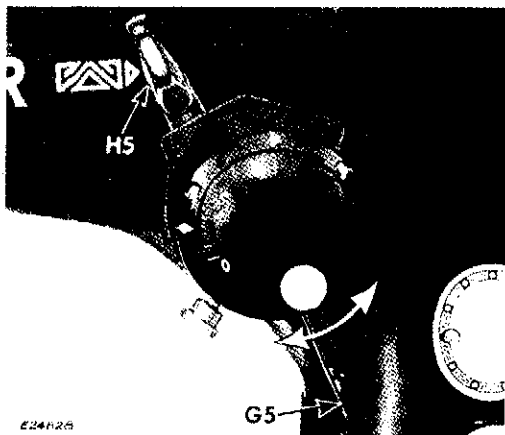

Fig. 125. Left Needle Position (Various Widths of Bight)

SETTING: Bight lever **G5** at any desired setting between "0" and #5 positions and position lever **H5** over to extreme left, as shown in **Fig. 125**.

STITCHING: Zigzag stitching produced at width desired up to maximum bight—the needle swinging from the extreme left toward the right. Variations of this stitching are shown in **Fig. 126**.

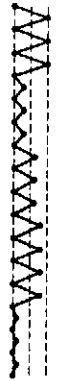

Fig. 126

NO. 10 ZIGZAG STITCH, VARIOUS WIDTHS, RIGHT NEEDLE POSITION

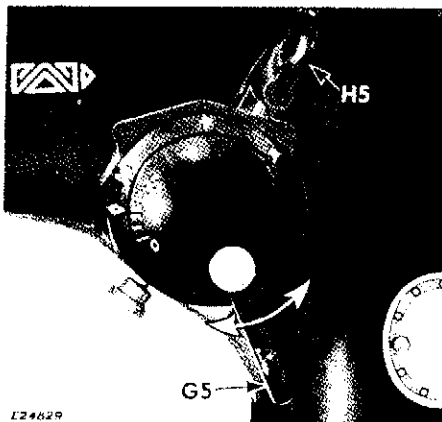

Fig. 127. Right Needle Position (Various Widths of Bight)

SETTING: Bight lever **G5** at any desired position between "0" and #5 positions and position lever **H5** over to extreme right as shown in **Fig. 127**.

STITCHING: Zigzag stitching produced at width desired up to maximum bight—the needle swinging from extreme right toward the left. Variations of this stitching are shown in **Fig. 128**.

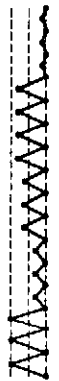

Fig. 128

NO. 11 ZIGZAG STITCH OF VARIOUS WIDTHS AND AT VARIOUS POSITIONS OF THE NEEDLE

SETTING: Bight lever **G5** at any desired position between "O" and #5 positions and position lever **H5** at any desired position from extreme left to extreme right, as shown in **Fig. 129**.

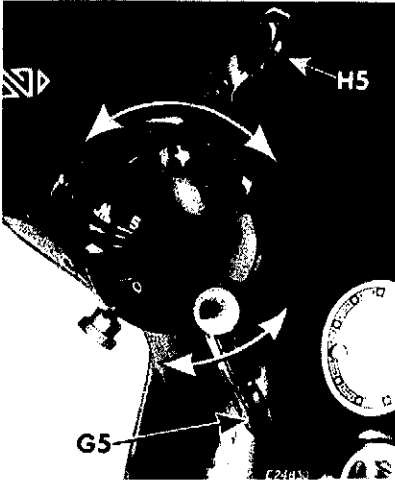

Fig. 129. Irregular Zig-Zag Setting

STITCHING: Zigzag stitching produced at width desired up to maximum bight—the needle swinging from various positions between the extreme left and extreme right of the central position. An example of this very irregular zigzag stitch is shown in **Fig. 130**.



Fig. 130

TO REMOVE THE BIGHT CONTROL MECHANISM

To remove bight control mechanism, set bight lever **G5**, **Fig. 131** at "O" on dial and set position lever **H5** at central position. Loosen the two screws **X5** and slide entire assembly out of machine arm.

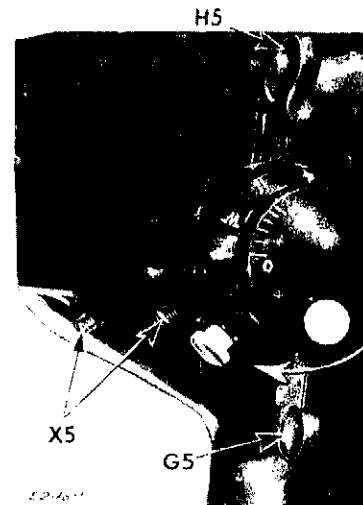

Fig. 131. Removing Bight Control

REASONS FOR REMOVAL

1. Misalignment of eccentric and slide block with bearing sleeve. See **page 73**.
2. Loose eccentric fastening screw. See **page 72**.
3. Excessive end-play in mechanism or tightness of levers. See **page 70**.
4. Left and right needle positions can not be adjusted to coincide with maximum bight positions of needle. See **page 61**.

SUB-ASSEMBLY ARRANGEMENT

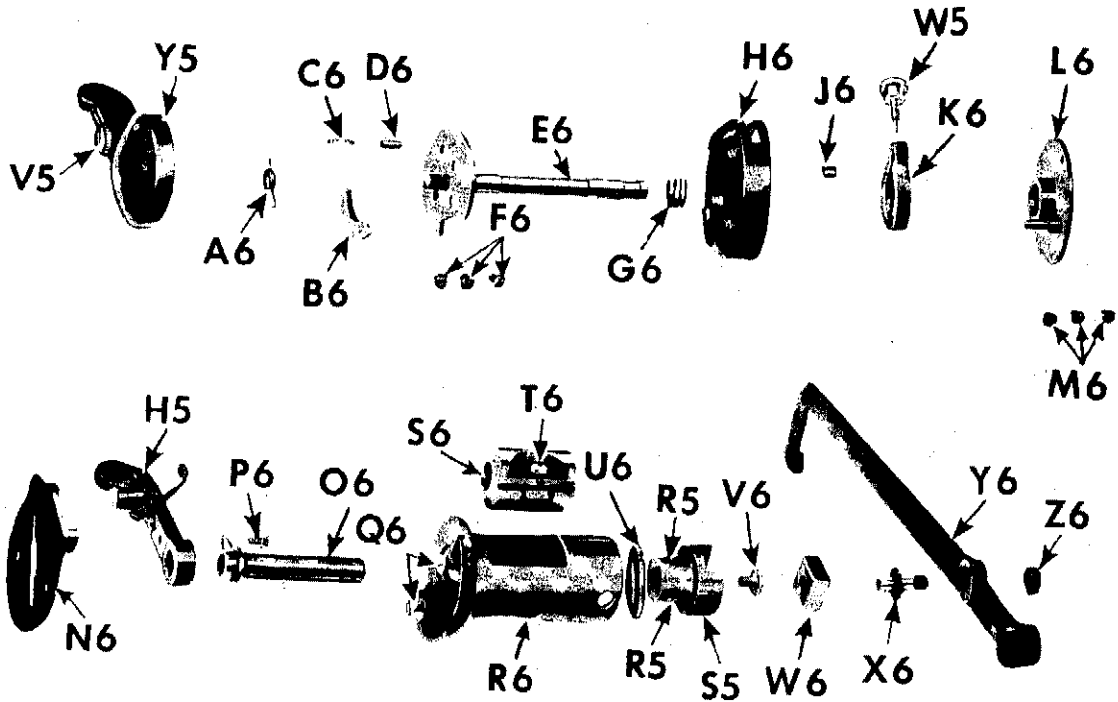

Fig. 132. Exploded View of Bight Control Mechanism

NOTE: Eccentric screw stud **X6**, nut **Z6** and Pitman **Y6** need not be removed from machine when removing bight control mechanism.

Ref.	Part No.	Ref.	Part No.	Ref.	Part No.
H5	105119	F6	934E	Q6	50156X
R5	50311AL	G6	105129	R6	105116
S5	105176	H6	105109	S6	105179
V5	SS668ZA	J6	105104	T6	SS697X
W5	SS669ZA	K6	105103	U6	105117
**Y5	105150	L6	105105	V6	1423E
A6	105107	M6	50362E	W6	105174
B6	105106	N6	105220	X6	SS695AL
C6	105102	O6	105120	Y6	105214
D6	105101	P6	140082E	Z6	1521X
E6	105108				

**Bight regulating lever can be ordered as a complete unit with screw SS668ZA and nut 1530AL. This unit has screw and nut secured so they will not easily vibrate loose or turn off.

TO DISASSEMBLE BIGHT CONTROL MECHANISM

REASONS FOR DISASSEMBLY

1. Bight limit screws not operating correctly. See **pages 70 to 72**.
2. Broken control levers—replacement required.
3. Control levers binding. See **pages 70 and 72**.
4. Failure of bight lever to engage intermediate stop. See instructions on **pages 63 and 71**.
5. Loose tenon plate screws. See **page 70**.

TO DISASSEMBLE BIGHT CONTROL MECHANISM

See **Fig 132**.

1. Remove bight limit thumb screw **W5**.
2. Remove slide block **W6** and tension screw **V6** from regulating slide **S5**.
3. Loosen the two set screws **R5** and remove regulating slide **S5** and thrust washer **U6** from sleeve assembly **R6**.
4. Loosen set screw **T6** and slide the regulating shaft **E6** out of eccentric **S6** and sleeve assembly **R6**.
5. Remove two screws **Q6** and separate tenon plate **N6** from sleeve assembly **R6**.
6. Remove position lever **H5** with its bushing **O6** from eccentric **S6** and sleeve assembly **R6**. Remove screw **P6** and separate position lever **H5** from its bushing **O6**.
7. Remove eccentric **S6** from sleeve assembly **R6**.
8. Slide the regulating scale assembly **H6** off regulating shaft **E6**.
9. Remove the three screws **M6** and separate retaining plate **L6** from regulating scale assembly **H6**.
10. Remove friction spring **G6**, regulating lever indent plate **K6** and small brass clamping pad **J6** from regulating scale assembly **H6**.
11. Remove the three screws **F6** and disengage regulating shaft **E6** from dial and bight lever unit **Y5**.
12. Remove plunger spring **C6** and plunger **D6** from regulating shaft flange.
13. Remove stop-shoe **B6** and spring **A6** from dial assembly **Y5**.

TO REASSEMBLE BIGHT CONTROL MECHANISM

The bight control mechanism should be assembled in the following manner, as illustrated in Figs. 132 to 146.

BEARING SLEEVE SUB-ASSEMBLY

See Figs. 133 and 134.

1. Slip eccentric **S6** into bearing sleeve **R6**, as shown in Fig. 133.
2. Assemble bushing **O6** to position lever **H5** and slide unit through eccentric **S6** and sleeve assembly **R6**, as shown in Fig. 134.

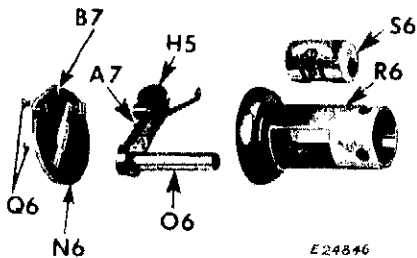

Fig. 133. Exploded View of Bearing Sleeve

3. Attach tenon plate **N6** to sleeve, with groove **B7** facing sleeve assembly, as shown in Fig. 134. Fasten securely with the two screws **Q6**.
4. Set position lever **H5** at point where position stop **A7** engages groove **B7** on tenon plate (central position). Align timing marks **T5** on eccentric and bearing sleeve, as shown in Fig. 134 and tighten eccentric screw **T6**.

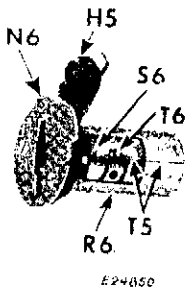

Fig. 134. Bearing Sleeve Reassembled

CAUTION: To avoid binding of position lever **H5**, do not tighten eccentric screw **T6** excessively.

INDICATOR PLATE SUB-ASSEMBLY See Figs. 135 and 136

5. Attach retaining plate **L6** to regulating scale **H6**; fasten securely with the three screws **M6**.
6. Place indent plate **K6** over hub of retaining plate with notch **C7** facing out, as shown in Fig. 136.

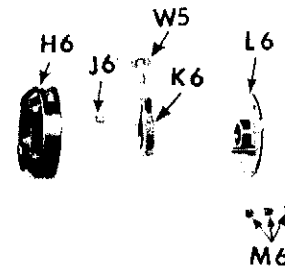

Fig. 135. Exploded View of Indicator Plate

7. Fit small brass clamping pad **J6** in recess between indent plate **K6** and hub of retaining plate, as shown in Fig. 136.
8. Insert bight limit screw **W5** through slot at side of regulating scale **H6** and thread screw **W5** into indent plate **K6**.

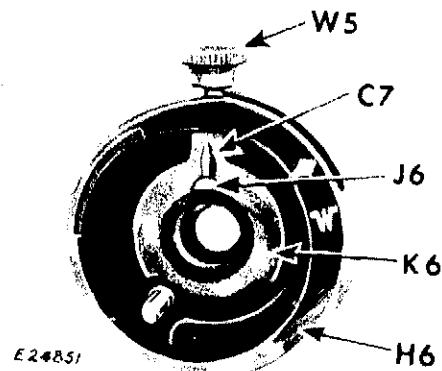

Fig. 136. Indicator Plate Reassembled

BIGHT LEVER SUB-ASSEMBLY See Figs. 137 to 140

9. Place stop-shoe **B6** into the curved channel at rear of dial unit **Y5**, with drilled end of shoe **B6** next to bight limit nut at position **Z5**, as shown in **Fig. 138**.
10. Engage hooked end of spring **A6** into hole at end of stop-shoe **B6** and set the spring in place as shown in **Fig. 138**.
11. Insert bight lever plunger spring **C6** into plunger **D6**, **Fig. 137**. Then insert the combination
12. Insert short end of regulating shaft **E6** into recess provided for it in rear of dial and bight lever unit **Y5**.
13. Using a narrow screwdriver, slide the stop-shoe **B6** back against its spring **A6** (counter-clockwise) until screwdriver drops down into recess behind stop-shoe, as shown in **Fig. 139**.
14. Rotate flange of shaft so that plunger **D6** and spring will slip into hole **D7**, **Fig. 138**.
15. Securely fasten shaft **E6**, **Fig. 138** in position with the three screws. Make certain that plunger **D6** works freely.
16. With screwdriver still in recess at **E5**, move stop-shoe **B6** back against its spring as far as it will go. Then securely tighten bight limit screw **V5**, **Fig. 139**.
17. Mount friction spring **G6**, **Fig. 140** on regulating shaft **E6**, so that ground face of spring faces flange on shaft.

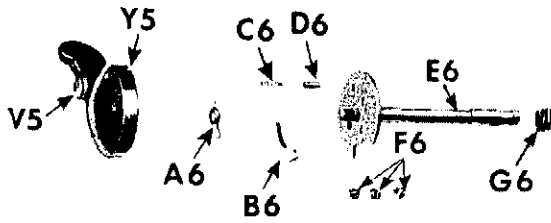

Fig. 137. Exploded View of Bight Lever

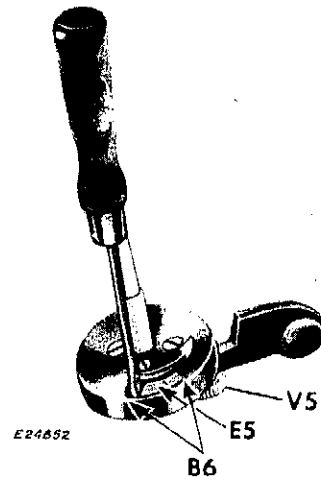

Fig. 139. Screwdriver in Recess behind Stop-Shoe

through hole at position **D6**, **Fig. 138** so spring remains in plunger and is facing hole at position marked for it at **D7**, **Fig. 138**.

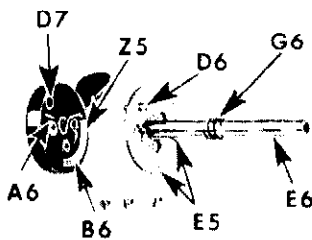

Fig. 138. Bight Lever Assembly

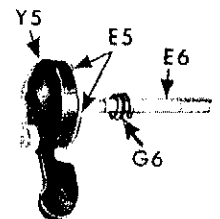

Fig. 140. Bight Lever Reassembled

COMPLETING ASSEMBLY See Figs. 141 and 142

18. Mount indicator plate sub-assembly on regulating shaft **E6** of bight lever sub-assembly, guiding stop pin **F7** into opening **E5** behind dial and bight lever unit **Y5**.

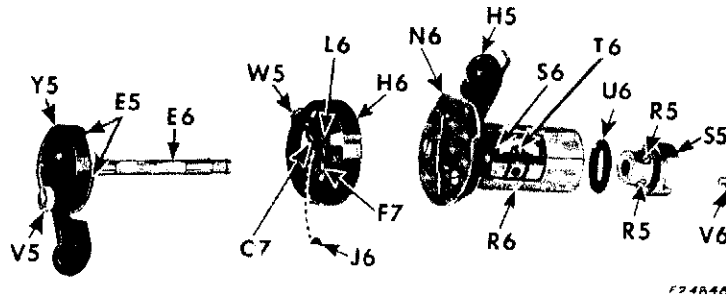

Fig. 141. Completing Assembly of Bight Control Mechanism

19. Insert regulating shaft **E6** into bearing sleeve sub-assembly, guiding the lugs on retaining plate at rear of indicator plate sub-assembly into slot of tenon plate **N6**.

20. Insert bearing sleeve thrust washer **U6** into sleeve **R6** so that its notch **G7** fits over lug **H7** inside sleeve, as shown in Fig. 142.

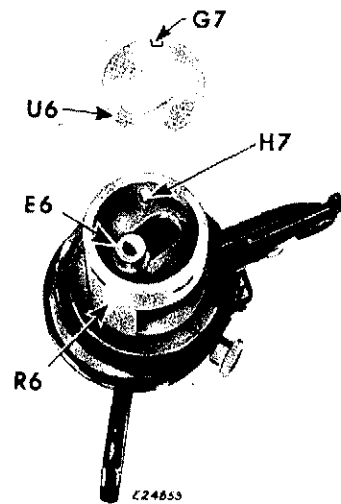

Fig. 142. Placing Thrust Washer in Sleeve

21. Mount slide **S5** on shaft and fasten in place with tension screw **V6**. Make certain that slide **S5** turns freely on shaft.

22. Set bight lever **G5**, Fig. 144 at "O" position. Loosen bight limit screw **V5**, Fig. 141 to release stop-shoe. Slide the stop-shoe until it closes the recess **E5** while maintaining lever **G5** at "O" position. Lock bight at "O" by retightening stop screw **E5**.

23. Set position lever **H5**, Fig. 144 at central position. Align timing mark on slide with timing marks on eccentric and sleeve as shown at **T5**, Figs. 143 and 144. Then set bight lever in

maximum bight position and align timing line on slide with that on cylinder **R6**. Then securely tighten the two set screws **R5** in slide **S5** and the set screw **T6** in the eccentric **S6**.

24. Tighten tension screw **V6** fully, then loosen screw **V6** about a quarter turn to permit ease of operation of control levers without danger of slipping.

TO INSTALL BIGHT CONTROL MECHANISM

NOTE: The two bearing surfaces of the slide **S5** and slide block **W6**, Fig. 143 can be easily detected by their brightness and smoothness in comparison with non-bearing surfaces.

Before installing bight control mechanism in machine arm, make certain that the two bearing surfaces of the slide block **W6** will engage the two bearing faces of the bight control slide **S5**, Fig. 145.

Set both control levers **G5** and **H5** at neutral position, as shown in Fig. 144, and slide entire assembly into arm.

By a slight rotary movement toward left or right, engage slide block **W6**, as shown in Fig. 145.

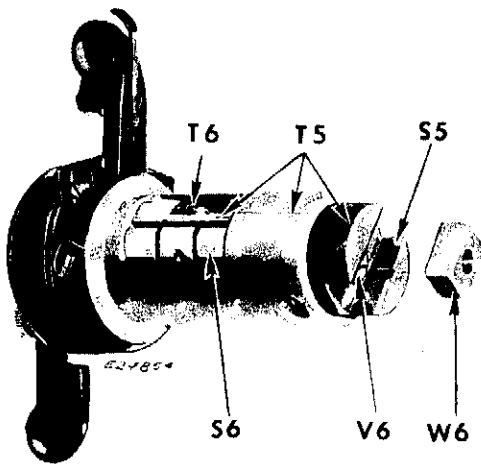

Fig. 143. Aligning Eccentric and Slide with Bearing Sleeve

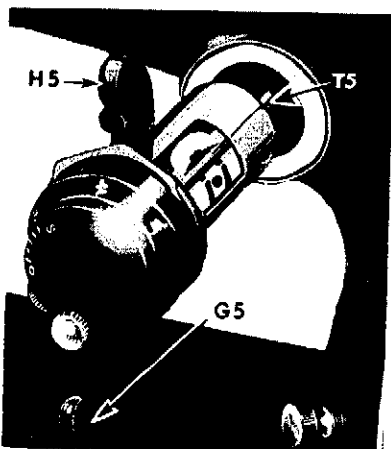

Fig. 144. Installing Bight Control Mechanism

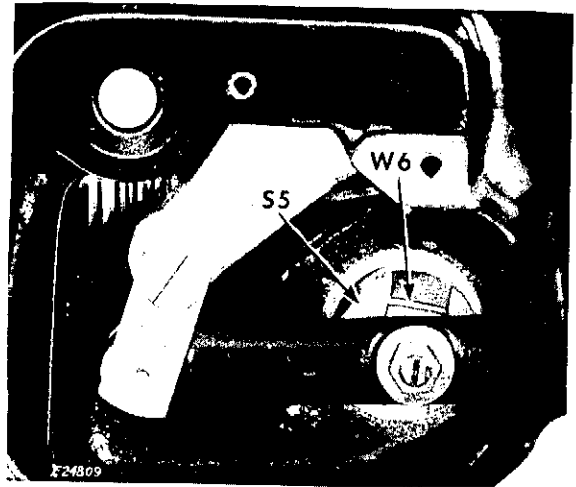

Fig. 145. Pitman and Regulating Slide Block

In some instances it will be necessary to move pitman back and forth and turn hand wheel until slide engages slide block.

In some stubborn cases, a mirror is helpful in engaging slide block.

While maintaining the position of levers **G5** and **H5** in neutral, rotate the hand wheel by hand and check for needle vibration. If needle vibrates, rotate the entire bight control unit toward the right or left until vibration at straight stitching is eliminated. Then tighten the two set screws **X5**, Fig. 146. See page 60 to eliminate needle vibration with a bight gauge.

Adjust bight controls in the same order as instructed on pages 60 to 63.

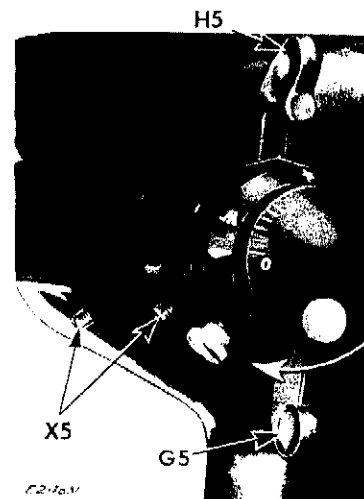

Fig. 146. Positioning Bight Control Mechanism

TO OIL THE MACHINE

Occasionally apply a drop of oil to all points indicated by unlettered arrows in **Figs. 147 to 152.**

Apply a small amount of oil to slide block **W6,** **Fig. 148.**

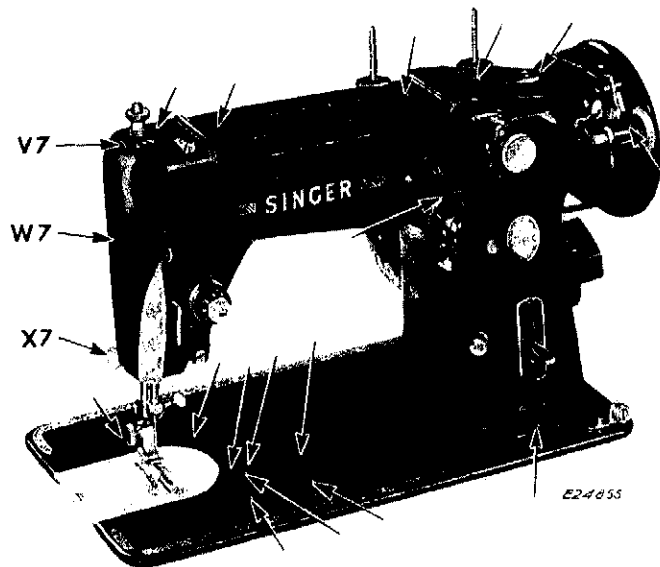

Fig. 147. Front View — Showing Oiling Points

Carefully clean the machine to insure smooth and satisfactory performance.

CAUTION: DO NOT LUBRICATE the arm shaft connection belt. To ensure the long life and effi-

When the arm shaft connection belt becomes loose or worn, it should be removed and replaced as instructed on **pages 25 to 28 and 89 to 90.**

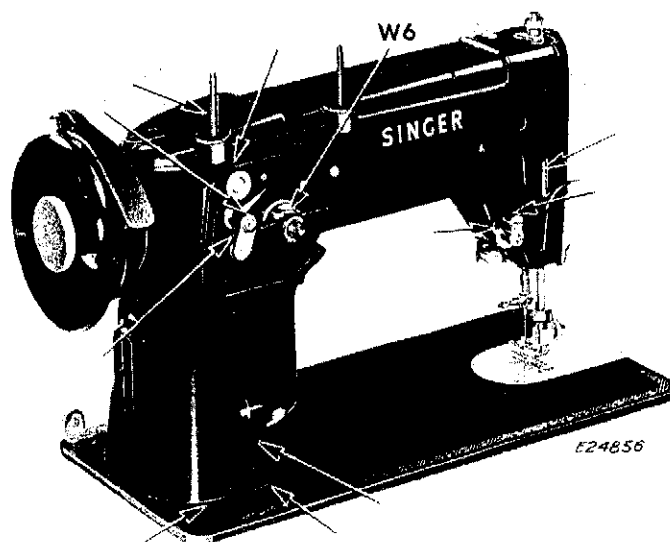

Fig. 148. Rear View — Showing Oiling Points

cient performance of the belt, it must be kept clean and free from excess oil at all times.

NOTE: Motor and sewing light have been removed for clearer view of parts but need not be removed when actually oiling machine.

Remove face plate **W7**, **Fig. 147** by taking out thumb screw **X7**, and slipping plate up and off screw at **V7**.

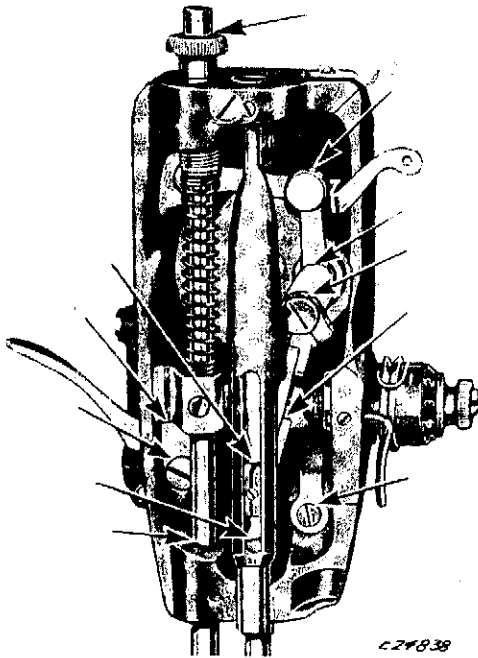

Fig. 149. Face Plate Removed Showing Oiling Points

Oil the points indicated by unlettered arrows in **Fig. 149**. Replace the face plate.

Apply a drop of oil to all other points indicated by unlettered arrows in **Figs. 147 and 148**.

TO GREASE GEARS

CAUTION: The grease, packed in the hook shaft gear case under the bed of the machine as shown in **Fig. 150**, does not require changing unless this section of the machine has been submerged in cleaning fluid. When necessary, remove the two screws at **E4**, **Fig. 150** and the gear case cover **D4** from gear case. Then repack the gear case with **SINGER GEAR LUBRICANT**.

This lubricant, No. **121915**, is obtainable in 4 oz. tubes on order from the factory. **DO NOT USE MOTOR LUBRICANT**, white lubricant S-6 or any other lubricant except **SINGER GEAR LUBRICANT** for this purpose.

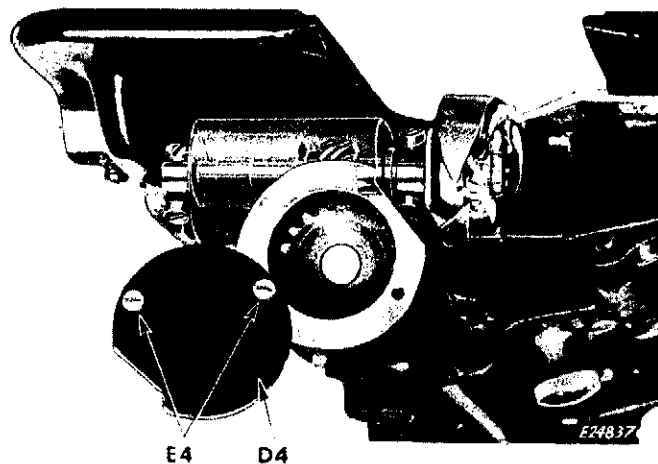

Fig. 150. To Grease Hook Shaft Gear Case

Occasionally apply a drop of oil to the race of the bobbin case holder as shown by unlettered arrow in **Fig. 151**.

Turn the machine back on its hinges and oil the places shown by unlettered arrows in **Fig. 152**.

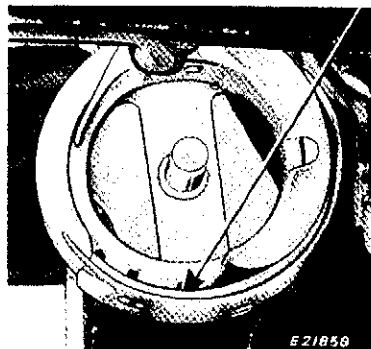

Fig. 151. Oiling Points in Bobbin Case Holder

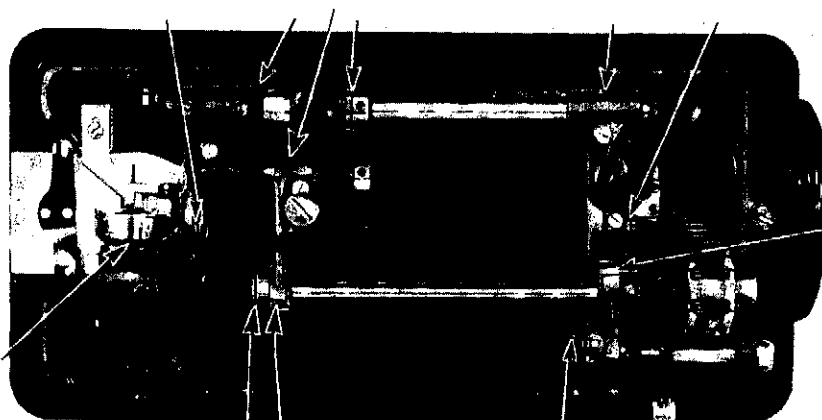

Fig. 152. Oiling Points in Base of Machine

CAUTION: DO NOT LUBRICATE arm shaft connection belt. See instructions on **pages 25 to 28** and **89** and **90** for replacing a loose or worn belt.

DANGERS OF OVER-LUBRICATION

The application of too much oil to the sewing machine parts can cause damage to the arm shaft connection belt, as explained on **page 74**, or can cause damage to fabrics and threads used during sewing. One or two small drops of oil at the right point, when

needed, will give the machine the protection it requires. Excess oil is merely a waste, as well as a source of danger to the appearance of the work accomplished on the machine.

CAUTION

DO NOT LUBRICATE THE MOTOR

On all latest machines shipped from the factory, the two grease tubes Y7, Fig. 153 have been eliminated.

The motor requires no lubrication.

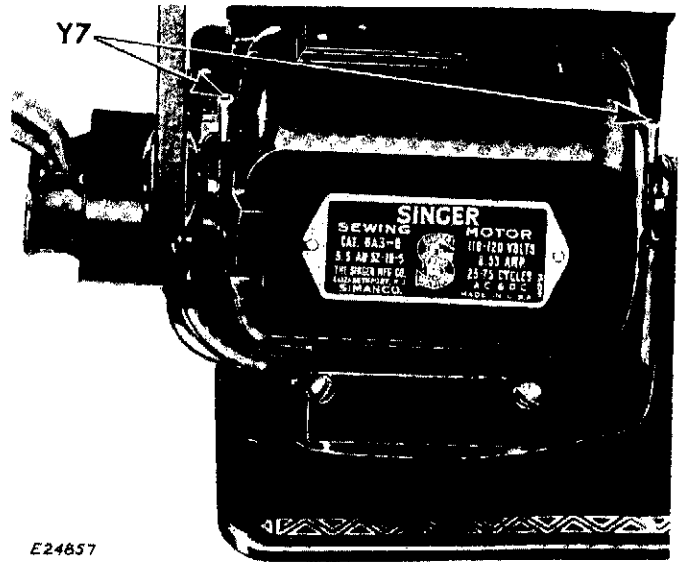

Fig. 153

TREATMENT OF MACHINES WHICH HAVE NOT BEEN USED FOR MONTHS

If machine runs heavily after standing idle for a long period, apply a few drops of kerosene or Varsol at all oiling points, run the machine for a few minutes,

then wipe clean. Apply SINGER Sewing Machine Oil as described on **pages 74 to 76.**

TO "RUN-IN" THE MACHINE

When a machine is completely assembled and adjusted, it should be checked for binding first. Then it should be "run-in" by an electric motor, for from 5 to 10 minutes at medium speed or until all moving parts run smoothly when machine is turned over by hand.

"Running-in" a machine should be done after every installation of an arm shaft, an arm cross shaft or an arm shaft connection belt, and after every general repair.

TO ADJUST THE STOP MOTION MECHANISM FOR WINDING BOBBINS

In order to operate the bobbin winder without running the stitching mechanism, it is necessary to release the stop motion mechanism in relation to the hand

the correct position of the **reversible** clamp washer **P**, **Fig. 155** to see if washer is against the hand wheel hub and washer prongs are in the bushing slots.

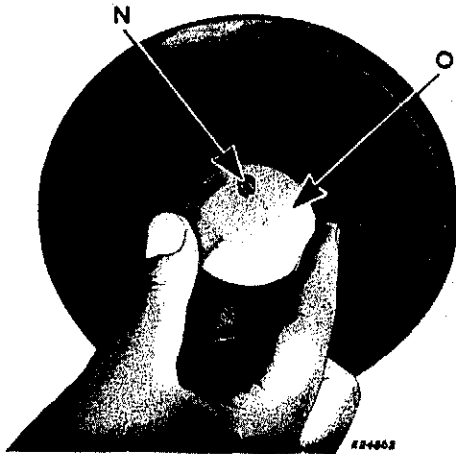

Fig. 154. Removing the Clamp Screw

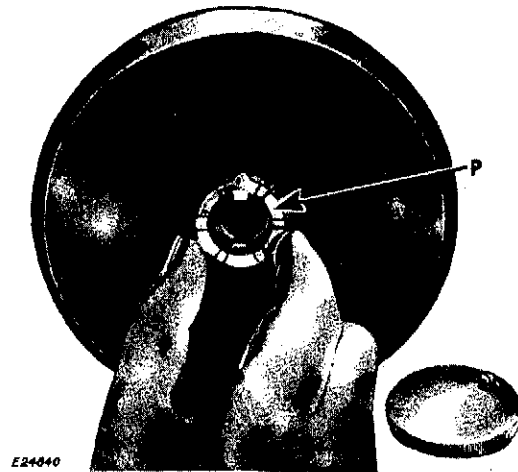

Fig. 155. Removing Reversible
Clamp Washer

wheel. To release the stop motion, hold the hand wheel and turn the stop motion clamp screw **O**, **Fig. 154** over counter-clockwise.

If the machine continues to run after the stop motion clamp screw **O** has been released, **remove it** by loosening the small screw **N**, **Fig. 154** which holds it in place; take off the clamp screw **O** and inspect the parts for wear, dirt, or hardened grease. Check

Before replacing the clamp stop motion washer **P**, remove the hand wheel and check for hardened oil, burrs on bushing or projecting set screw on flanged bushing. Dress down burrs with a fine file. Remove hardened oil with a wire brush or with steel wool. Lubricate the bushing and replace hand wheel. Replace washer **P**.

NOTE: See **page 90** for correct position of a **one-way** clamp stop motion washer.

CAUTION: When replacing clamp screw **O**, be careful that small screw **N** does not rest directly on any of the three external tabs of washer **P**.

TO ADJUST THE BOBBIN WINDER

The pressure of the rubber ring in **Fig. 156**, on the bobbin winder against the hub of the hand wheel, must be sufficient to wind the bobbin.

CAUTION: Too much pressure may cause needless wear of the rubber ring.

To adjust the pressure, press down bobbin winder until latch **A8**, **Fig. 156** drops down and holds the bobbin winder spindle. Loosen screw **B8** and while holding rubber ring firmly against hub of hand wheel, press down on tripper arm at **Z7**, **Fig. 156** to **increase** the pressure, or at **C8**, **Fig. 156** to **decrease** the pressure. When sufficient pressure is obtained, securely tighten screw **B8**.

NOTE: If the rubber ring becomes worn, or if oil has been allowed to come in contact with it, the ring will not have the proper contact with the hand wheel

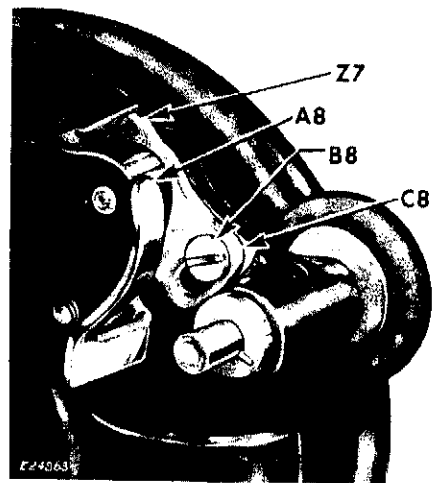

Fig. 156. Adjusting Bobbin Winder

hub and may slip when attempting to wind a bobbin. A worn or oily ring should be replaced.

TO WIND BOBBINS EVENLY

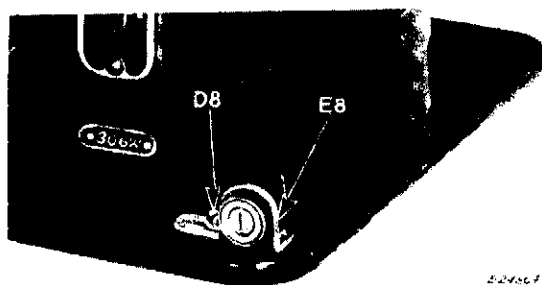

Fig. 157. Adjustment for Winding Bobbins Evenly

If bobbin does not wind evenly, loosen screw **D8**, **Fig. 157**, which holds tension bracket **E8** in position. Move bracket to the left if bobbin winds high on the right; move bracket to the right if bobbin winds high on the left. When bracket is properly centered, thread will wind evenly across bobbin. Retighten tension bracket screw **D8**.

Bobbin can be wound while machine is sewing.

)

)

)

SINGER NON-AUTOMATIC SWING-NEEDLE MACHINES OF CLASS 306 AND MACHINE 206K43

The instructions on pages 1 to 79 generally apply to Non-automatic Swing-Needle Machines of Class 306 and Machine 206K43. Specific instructions applying to parts of the machines which differ from those of the automatic machines are covered on pages 82 to 85.

TO REMOVE NEEDLE VIBRATOR FORK CONNECTION

Remove the connection as follows:

1. Remove needle and move arm side cover upward so fork is visible.
2. Loosen set screw **Y8**, **Fig. 159** and remove cam from shaft **W8**.
3. Remove hinge screw **F9**, **Fig. 158** from crank.
4. Lift fork from machine while guiding slide block **W6**, **Fig. 159** from slide.

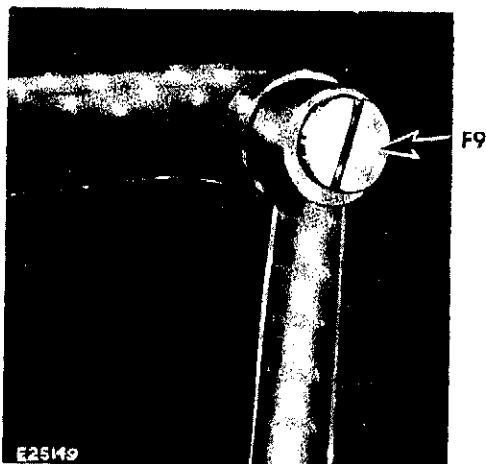

Fig. 158. Releasing Fork at Crank

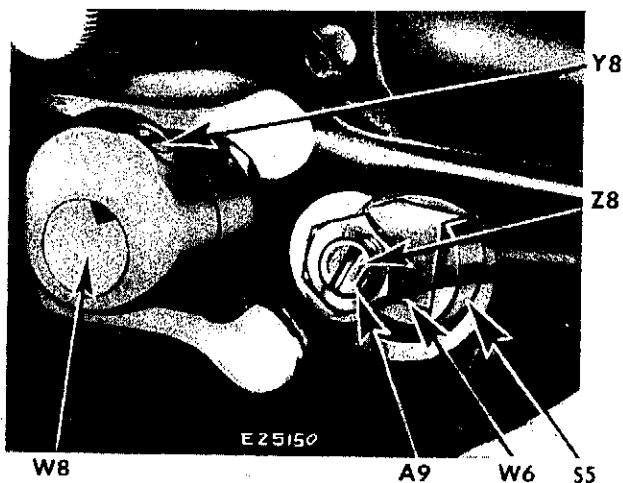

Fig. 159. X-ray View of Block and Slide

TO REPLACE NEEDLE VIBRATOR FORK CONNECTION

Replace the connection as follows:

1. While guiding the two bright bearing surfaces of slide block **W6**, **Fig. 159** into slide **S5** on right mechanism, be certain shaft **W8** is between prongs of vibrator fork.
2. Set right end of fork into position at crank and tighten hinge screw **F9**, **Fig. 158**.
3. Set cam on shaft **W8**, **Fig. 159** with set screw **Y8** over the notch in shaft and two edges of fork over the cam surface.
4. While pressing cam in **Fig. 159** toward fork, push gear in **Fig. 160** toward cam with a screwdriver to eliminate excessive play and noise. Securely tighten set screw **Y8**, **Fig. 159** without binding machine. If machine binds, reset cam.
5. Replace needle and set arm side cover in place.

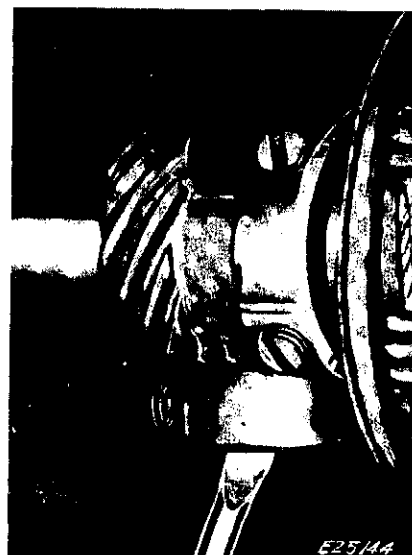

Fig. 160. Removing End Play from Shaft

NOTE: If needle vibrates, see **page 84**.

TIMING PENDULUM MOVEMENT OF NEEDLE BAR WITHOUT GAUGE

Set the bight control lever **G5** at maximum bight and position lever **H5** at its central setting as shown in **Fig. 78, page 52**.

Observe the needle vibrator lever **Z4, Fig. 80, page 52**, while slowly turning hand wheel over toward operator and follow steps **1 through 5** on **page 53**.

The correct and incorrect path of needle pendulum movement is shown in **Figs. 82 and 83, page 53**.

To time the pendulum movement of the needle bar, loosen two set screws **U8, Fig. 161** in spiral gear **V8** in the gear box on top of the machine and free gear **V8** from arm shaft.

Rotate arm shaft by turning hand wheel over toward the operator or away from operator while keeping gear **V8** in place by holding a screwdriver over one of two set screws **U8**. When a desired setting is obtained, tighten one of two set screws **U8, Fig. 161** and recheck pendulum movement. If results are satisfactory, securely tighten both screws.

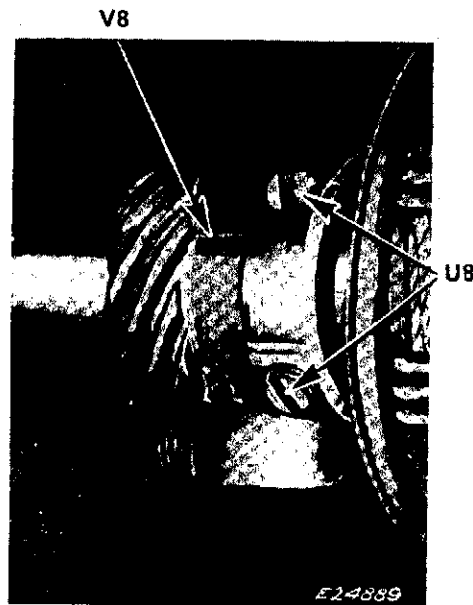

Fig. 161. Adjusting Needle Pendulum Movement

TO ELIMINATE NEEDLE VIBRATION WITH GAUGE

With all bight controls in neutral, there must not be any needle vibration (side movement) in any of the straight stitching positions of the needle.

If needle vibrates:

1. Loosen set screw **Y8** and remove cam **X8** from shaft **W8**.
2. Select gauge Tool No. Serial 198351, and slip gauge on shaft as shown at **B9**, **Fig. 163**.
3. Loosen lock nut **A9**, **Fig. 162** on fulcrum stud **Z8**.
4. Turn stud **Z8** (clockwise or counter-clockwise) until needle bar vibration is eliminated while continually moving bight control lever from zero to full bight as shown in **Fig. 164**.

5. Hold fulcrum stud **Z8**, **Fig. 162** in position with a screwdriver to keep the correct setting obtained and carefully tighten lock nut **A9** with a wrench.
6. Remove gauge **B9**, **Fig. 163** and position cam **X8**, **Fig. 162** on shaft **W8** with set screw **Y8** over the notched shaft.
7. While pressing cam **X8**, **Fig. 162** toward fork, push gear in **Fig. 165** toward cam with a screwdriver to eliminate excessive play and noise. Securely tighten screw **Y8**, **Fig. 162** without binding machine.

NOTE: Should needle bar continue to vibrate, it is recommended that the bight control be removed and rechecked for proper alignment.

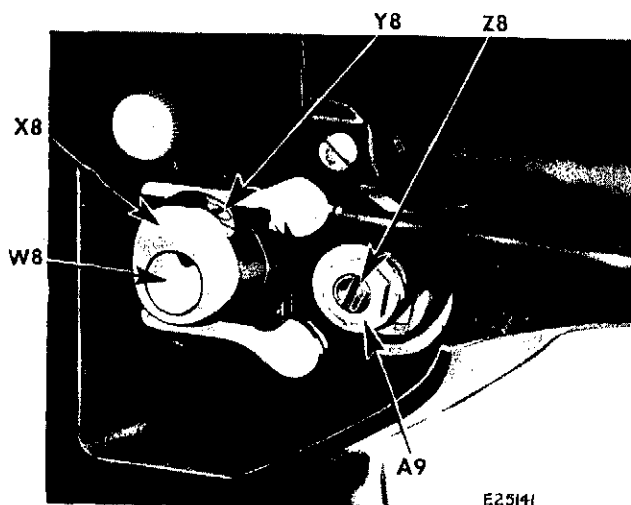

Fig. 162. Removing and Replacing Cam

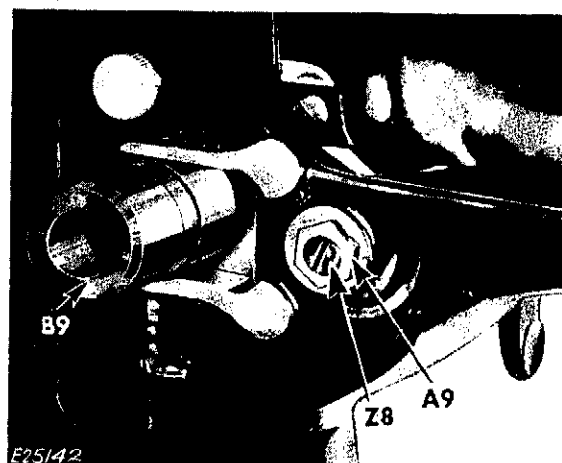

Fig. 163. Using Gauge to Eliminate Needle Vibration

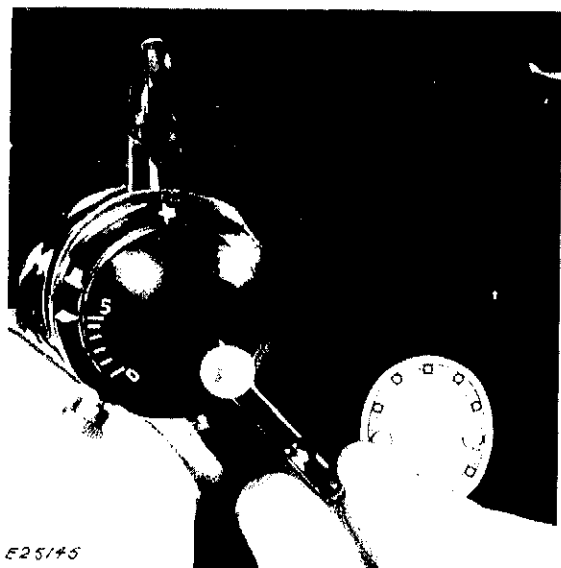

Fig. 164. Moving Bight Control from Zero to Full Bight



Fig. 165. Removing End Play from Shaft

SUB-ASSEMBLY ARRANGEMENT

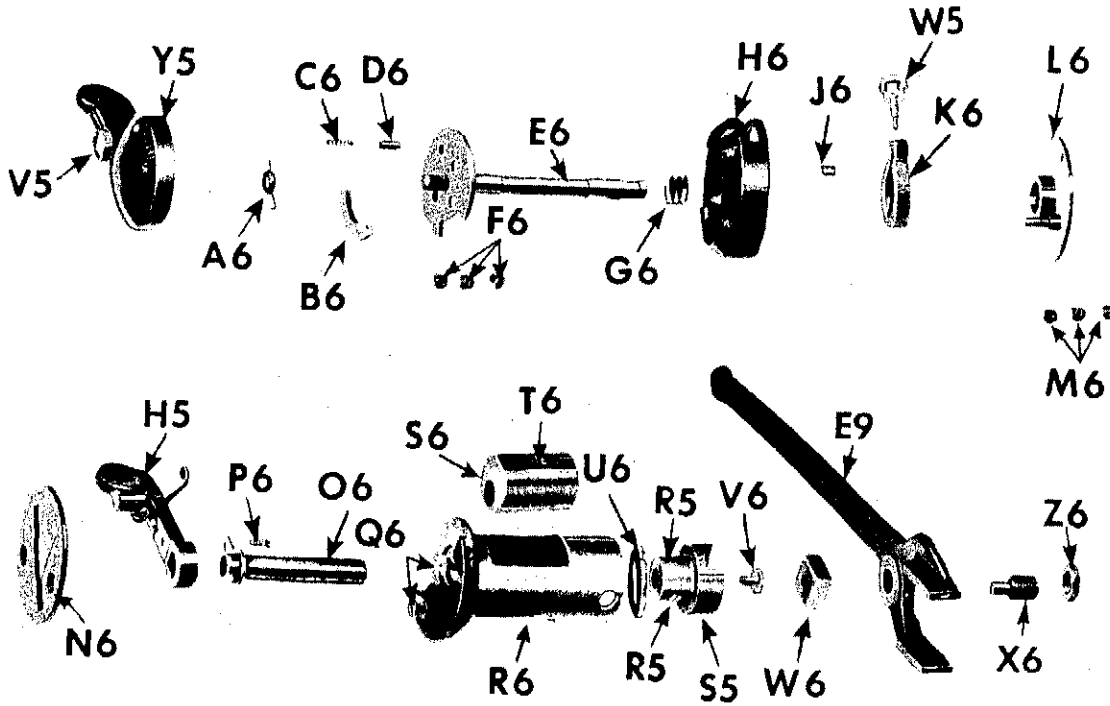

Fig. 166. Exploded View of Bight Control Mechanism

NOTE: Eccentric screw stud **X6**, nut **Z6** and needle vibrator fork connection **E9** need not be removed from machine when removing bight control mechanism.

Disassemble and reassemble bight control mechanism as instructed on pages 69 to 73.

Ref.	Part No.	Ref.	Part No.	Ref.	Part No.
H5	105119	F6	934E	Q6	50156X
R5	50311AL	G6	105129	R6	105116
S5	105114	H6	105109	S6	105118
V5	SS668ZA	J6	105104	T6	448AL
W5	SS669ZA	K6	105103	U6	105117
**Y5	105150	L6	105105	V6	1423E
A6	105107	M6	50362E	W6	188415
B6	105106	N6	105121	X6	SS670X
C6	105102	O6	105120	Z6	1517X
D6	105101	P6	140082E	E9	105111
E6	105108				

**Bight regulating lever can be ordered as a complete unit with screw SS668ZA and nut 1530 AL. This unit has screw and nut secured so they will not easily vibrate loose or turn off.



SINGER NON-AUTOMATIC SWING-NEEDLE MACHINE 206K25

The instructions on pages 1 to 85 generally apply to 206K25 Non-automatic Swing-Needle Machines. Specific instructions which apply only to Machine 206K25 appear on pages 88 to 102.

LOCATION OF NEEDLE IN NEEDLE CLAMP

If the needle is incorrectly placed in the needle clamp and is incorrectly threaded, the machine will not sew.

Be certain that needle is **not** blunt or bent.

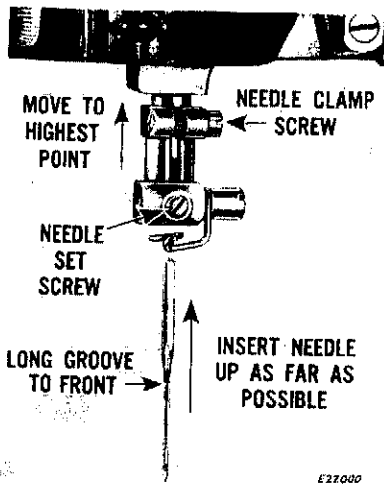

Fig. 167. Setting the Needle

Loosen needle set screw and insert needle in the needle clamp slot, all the way up against the stop, with the flat side of the shank of the needle, see Fig. 168, facing the rear of machine, away from the operator, then securely tighten needle set screw.

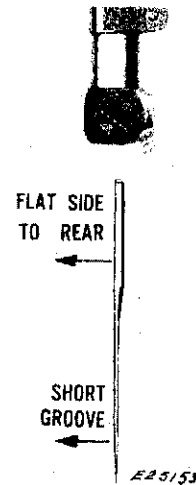

Fig. 168. Flat Side of Needle (Enlarged)

You will note from Fig. 168 that the side of the needle with the flat on the shank has a **short** groove at the eye, while the opposite side, shown in Fig. 167, has a **long** groove. On all machines, the needle is threaded from the long groove side toward the short groove; thus the needle on this machine is threaded from front to rear.

TO REMOVE ARM SHAFT CONNECTION BELT FROM WITHIN THE ARM

To remove arm shaft connection belt proceed as follows:

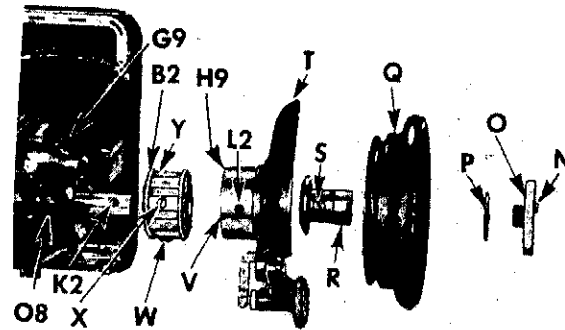

Fig. 169. Removing and Replacing Arm Shaft Connection Belt

Remove needle from needle clamp.

Slide belt off lower sprocket.

Loosen stop motion stop screw **N**, Fig. 169 and remove the following parts:

Clamp screw **O**

Washer **P**

Hand Wheel **Q**

Flanged bushing screw **S** and bushing **R**

Arm shaft bushing set screw **G9**

Arm top cover

Lift belt to left of arm shaft sprocket and loosen sprocket screws **X** and **W**, Fig. 169 so that heads of

screws are flush with surface of sprocket. Failure to raise screws above flat on arm shaft will burr the edge of the flat which will prevent removal of sprocket.

If flanged bushing **R** is difficult to remove, it can be removed simultaneously with rear arm shaft bushing and bobbin winder complete as instructed below.

To remove arm shaft bushing **V**, press fingers against sprocket to ease out sprocket and assembly. (If bushing resists finger pressure, use 5/16 inch brass drift punch against side of sprocket to ease bushing past arm bearing.)

Remove sprocket **Y**.

Insert finger through arm shaft hole inside loop of belt. Then snake out belt as shown in Fig. 27, page 25.

TO REPLACE ARM SHAFT CONNECTION BELT

Replace arm shaft connection belt and sprocket as described and illustrated on page 26 then proceed as follows:

Replace non-reversible clamp washer **R**, Fig.

170 against hand wheel hub with inner prongs

complete by sliding arm shaft bushing along arm shaft while aligning oil hole **L2**, Fig. 169 in bushing with oil hole **O8** in arm and setting long groove **H9** on arm shaft bushing opposite set screw **G9**. Securely tighten set screw **G9**.

If arm shaft bushing resists finger pressure, make sure there are no burrs along bearing edge. A few light strokes of a file or a light dressing down with very fine emery cloth will help to ease bushing into place.

One end of screw hole **K2**, Fig. 169 near end of arm shaft has a seat for hand wheel bushing screw **S**. This seat, like the large hole in the hand wheel bushing, must be in the uppermost position to properly fasten bushing in place.

Drop screw **S** into screw hole and, just before fastening bushing in place, slide a .005 inch shim between bearing and bushing. Press bushing against shim and then lock the screw in position. This method of locating bushing will insure adequate heat expansion clearance and eliminate binding.

Replace hand wheel **Q** on flanged bushing, as shown in Fig. 170.

Replace arm shaft bushing with bobbin winder **M2** set in the slots of the bushing, but projecting outward, to make contact with stop motion clamp screw **O**. Replace clamp screw **O** and tighten stop screw **N**.

NOTE: See page 27 to replace a reversible clamp washer.

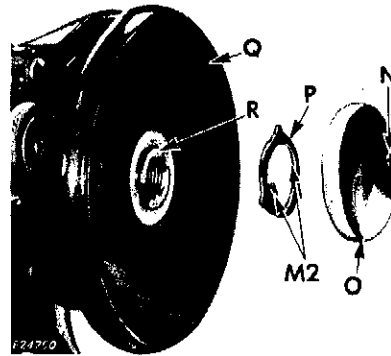

Fig. 170. Replacing Stop Motion Mechanism

To locate sprockets and belt properly, see last two paragraphs on page 27 and follow instructions on page 28.

NEEDLE-PERFORATION TESTS

The adjustment of the bight control mechanism discussed on the following pages, should be checked by means of needle-perforation tests.

It is important to the accuracy of these tests that the paper should be held securely upon the throat plate and under the needle in such a way that it will

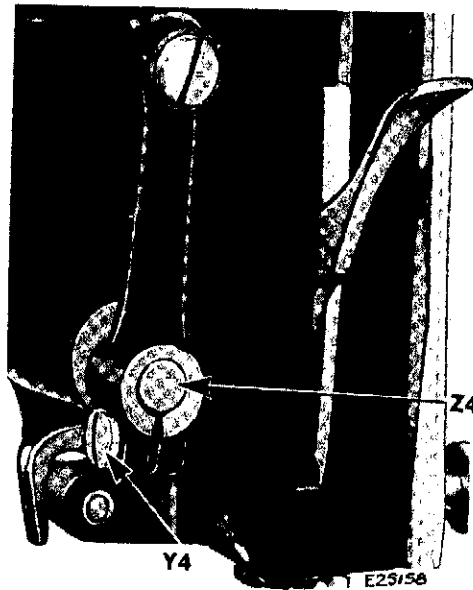

Fig. 171. Adjusting Sidewise Position of Needle

To prepare for these tests, remove the presser foot, throat plate and feed dog. Then replace the throat plate.

To make a needle perforation test, place a sheet of notepaper over the throat plate. Turn hand wheel forward until needle makes a slight perforation in the paper, then backward until another perforation is made. Repeat this operation for each test required, as instructed on the following pages.

To insure an accurate reading during these tests, the perforations should be as small as possible—the needle barely pricking the paper at each test position. Use a Size #9 needle.

not move in any direction throughout each complete test.

If the needle strikes the throat plate during these tests, loosen clamping screw **Y4**, **Fig. 171** gradually so as to retain a pinch hold on the fork shaft **Z4**. Then move needle bar to left or right and securely tighten screw **Y4**.

Before checking the bight control mechanism, back off the limit screw **J9**, **Fig. 172** so that the bight control lever **K9** at its highest position will contact the limit screw boss only, instead of the screw.

TO ADJUST THE CENTRAL SETTING OF THE NEEDLE (STRAIGHT STITCHING)

The bight control mechanism must be adjusted so that when position lever **L9** is moved to its lowest (central) setting and bight control lever **K9** to its lowest (zero bight) position, as shown in **Fig. 172**,

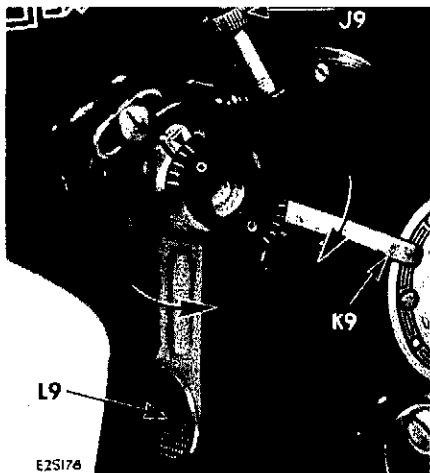

**Fig. 172. Lever Settings—
Straight Stitching at Central Position
of Needle**

Then place a piece of paper over the throat plate and by means of the needle-perforation test, described on **page 91**, establish the two extreme positions of the needle at this setting. Then move the bight

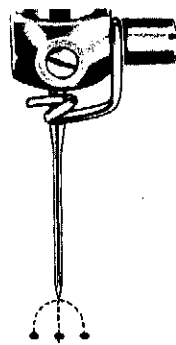

**Fig. 173
Needle Perforation
Test**



**Fig. 174
Sample of
Stitching**

(Straight Stitching and Maximum
Zigzag Stitching at Central
Position of Needle)

the machine will perform straight stitching midway between the two extremes of maximum bight. See **Fig. 174**.

To centralize the zero bight position between the two extreme positions of maximum bight, remove the presser foot, set bight control lever **K9**, **Fig. 172** at **highest** (maximum bight) position and position lever **L9** at its **lowest** (central) setting.

control lever **K9**, **Fig. 172** to its lowest (zero bight) position, as shown in **Fig. 172**, and make the single perforation of the needle representing straight stitching at central setting, as shown in **Fig. 173**. This perforation should be midway between the other two.

NOTE: When the above setting has been correctly adjusted there will be **no vibration of the needle bar** during straight sewing. See **page 102**.



Fig. 175

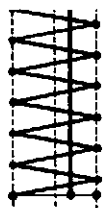

Fig. 176

If this single perforation is **nearer to the right-hand** perforation made at maximum bight setting, as shown in **Figs. 175 and 176**, remove bight control mechanism from the machine as instructed on **pages 99 and 100**, and, raising position lever **L9**, **Fig. 179** slightly, screw the upper set screw **N9**, **Fig. 179**, **inward**. Replace mechanism and recheck.



Fig. 177

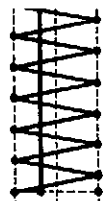
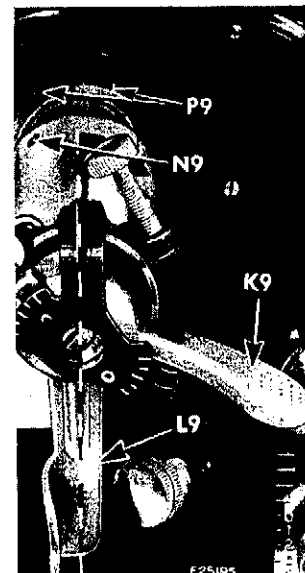

Fig. 178

If this single perforation is **nearer to the left-hand** perforation made at maximum bight setting, as shown in **Figs. 177 and 178**, remove mechanism (see **pages 99 and 100**) and, raising position lever slightly, screw upper set screw **N9** **outward**. Replace bight control mechanism and recheck.

NOTE: Each time that the bight control mechanism is replaced in machine, it must be adjusted at zero bight, as instructed on **page 102**.



**Fig. 179. Adjustment
for Straight Stitching
Central Setting**

TO COORDINATE CENTRAL AND LEFT-HAND SETTINGS OF THE NEEDLE DURING ZIGZAG STITCHING

The bight control mechanism should be now adjusted so that the two extreme positions of the needle, at maximum bight and **central** setting **coincide** with the two extreme positions of the needle at maximum bight and **left-hand** setting, as shown by the sample of stitching in **Fig. 183**.

position, as shown in **Fig. 180**, while loosening screws **O9**, **Fig. 180**, on hub of bight control lever and rotating slideway **P9**, **Fig. 184**, at rear of machine over toward hand wheel to a position where the needle perforations coincide. Then securely tighten screws **O9** and recheck.

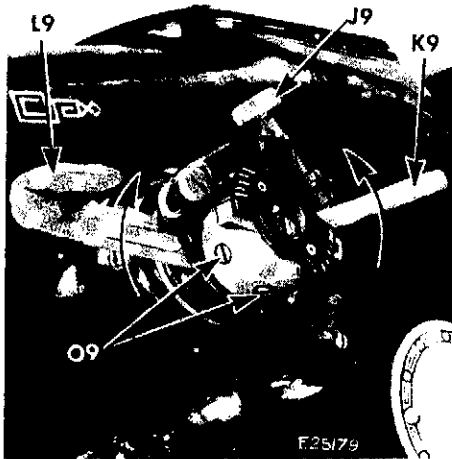

Fig. 180.
Lever Settings—
Maximum Zigzag at
Left-Hand Position
of Needle

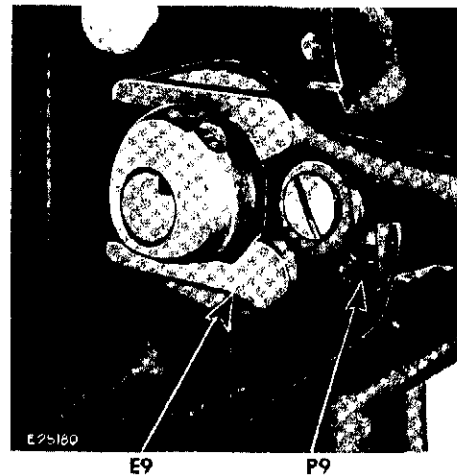

Fig. 184. Needle Vibrator Slideway

Check the two extreme positions of the needle at maximum bight, by means of the needle-perforation test, first with the position lever at its lowest (central) setting and then with the position lever at its highest (left-hand) setting as shown in **Fig. 180**. The two extreme positions of the needle at left-hand setting should respectively coincide with the extreme positions of the needle at central setting.

If the two perforations made at left-hand setting are to the right of the perforations made at central setting, as shown in **Figs. 181** and **182**, hold bight control lever **K9** securely at maximum bight and position lever at its highest



Fig. 185.

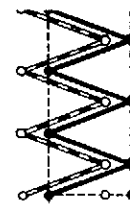

Fig. 186.

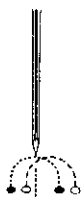

Fig. 181.
Needle Perforation
Test

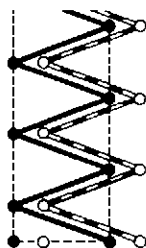

Fig. 182.
Incorrect
Sample of
Stitching

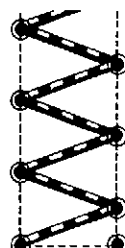

Fig. 183.
Correct
Sample of
Stitching

If the two perforations made at left-hand setting are to the **left** of the two perforations made at central setting, as shown in **Figs. 185** and **186**, hold bight control lever **K9** securely at its highest position, while loosening the two screws **O9** and rotating the slideway **P9** over away from the hand wheel to a position where the needle perforations coincide. Then securely tighten the two screws **O9** and recheck.

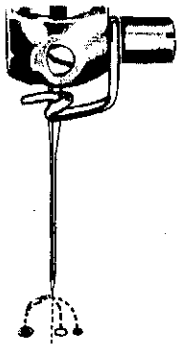

Fig. 187.

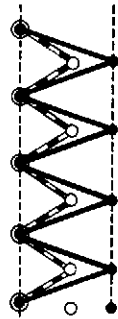

Fig. 188.

It may be found that **only one** of the two extreme positions of the needle at one setting **coincides** with its respective needle position at the other setting, while the opposite extreme position does not, as shown in **Figs. 187** and **188**. This variation, which will be slight when it does exist, is permissible and no further adjustment is necessary.

NOTE: Coordination of the two positions of the needle at central and left-hand settings can be **tested** also by setting the bight control lever at maximum bight and moving the position lever several times between its highest and lowest points, while watching the vibrator fork connection **E9**, **Fig. 184**. There will be no movement whatsoever of the vibrator fork connection **E9** during this test, if the bight control is properly adjusted. **Adjustment** is accomplished in the same manner as instructed on **page 93**.

When these two settings of the bight control mechanism are coordinated, recheck and adjust the position of the needle at zero bight as described on **page 102**.

TO ADJUST THE LEFT-HAND SETTING OF THE NEEDLE AT STRAIGHT STITCHING

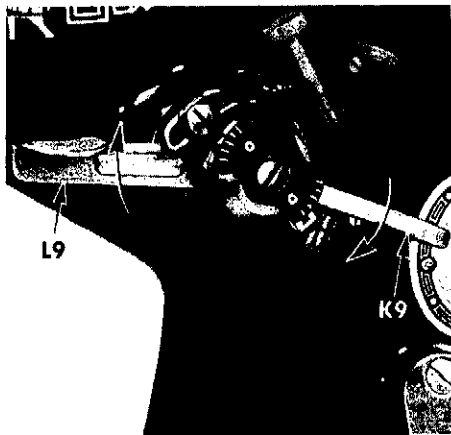

Fig. 189.
Lever Settings—
Straight Stitching at Left-Hand
Position of Needle

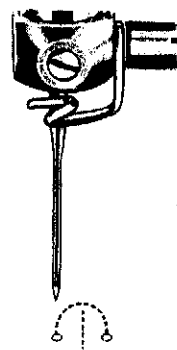

Fig. 190.
Needle Perforation
Test

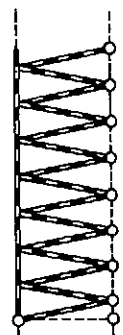

Fig. 191.
Sample of
Stitching

(Straight Stitching and Maximum Zigzag
Stitching at Left-Hand Position of
Needle)

The bight control mechanism must be adjusted so that when the bight control lever **K9**, **Fig. 189** is moved to its lowest (zero bight) position and the position lever **L9** is at its highest (left-hand) setting,

the machine will perform straight stitching at the extreme left-hand position of the needle at maximum bight as shown in **Figs. 190** and **191**.

To check whether the zero bight (straight stitching) position coincides with the extreme left-hand position of the needle at maximum bight, move bight control lever **K9** to its highest (maximum bight) position and position lever **L9** to its highest (left-hand) setting. Place a piece of note-paper over the throat plate and, by means of the needle-perforation test described on **page 91**, establish the two extreme positions of the needle at this setting. Then move the bight control lever **K9** to its lowest (zero bight) position, as shown in **Fig. 192**, and make the single perforation of the needle, representing straight stitching at left-hand setting.

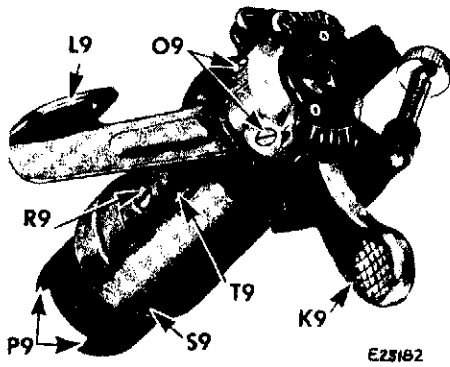

Fig. 192. Adjustment for Straight Stitching, Left-Hand Setting

If the single perforation made at zero bight, is to the **right** of the left-hand perforation made at maximum bight as shown in **Figs. 193** and **194**, remove bight control mechanism (see **pages 99** and **100**) and screw the lower set screw **S9**, **Fig. 192** **outward**. Replace mechanism and recheck.

If the single perforation is to the **left** of the left-hand perforation made at maximum bight, as shown in **Figs. 195** and **196** remove bight control mechanism (see **pages 99** and **100**) and screw the lower set screw **S9**, **Fig. 192** **inward**. Replace the bight control mechanism in the machine, adjust for zero bight, as instructed on **page 102** and recheck left-hand setting.

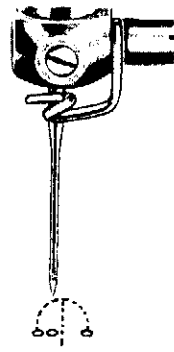

Fig. 193.

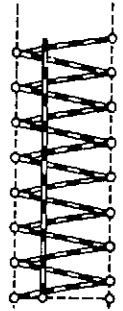

Fig. 194.

CAUTION: After each adjustment involving regulating slideway **P9**, **Fig. 192**, eccentric sleeve **T9**, hub screws **O9**, stop screws **S9** and **R9**, **Fig. 192**, all positions of the needle determined by the opera-

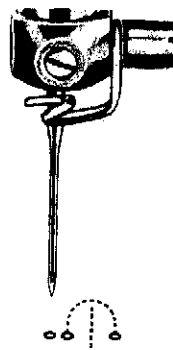

Fig. 195.

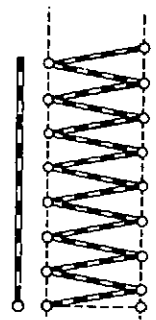

Fig. 196.

tion of the bight control mechanism must be rechecked, as it is quite possible, while correcting one, to over-correct another previously made adjustment.

BIGHT





The width of the zigzag movement of the needle, while stitching, is termed the **BIGHT**. See **Figs. 197** to **201**. The mechanism, in the upright part of the machine arm, which controls the width and the position of the bight is called the **BIGHT CONTROL**.

The width of bight is sometimes referred to as the "swing of the needle" or the "needle vibration."

The sidewise position of the needle during straight or zigzag stitching is determined by the setting of the **needle bar position lever L9, Fig. 202**.

The width of the bight is determined by the setting of the **bight control lever K9, Fig. 202**.

STITCHING AT VARIOUS WIDTHS OF BIGHT

SETTINGS ON BIGHT CONTROL SCALE	"0"	#1	#2	#3	#4
APPROXIMATE INCH	0	3/64	3/32	9/64	3/16
SAMPLE OF STITCHING (actual size)					
	ZERO BIGHT Fig. 197	Fig. 198	Fig. 199	Fig. 200	MAX. BIGHT Fig. 201

When the bight control lever **K9, Fig. 202** is at its **lowest position**, the machine is set at **zero bight** and should perform **straight stitching** only as shown in **Fig. 197**.

When the bight control lever **K9** is at its **highest position**, the machine is set at **maximum bight** and should perform zigzag stitching approximately 3/16 inch wide, as shown in **Fig. 201**.

The bight control lever **K9** may also be set at positions **#1, #2** or **#3** on the Bight Control Scale **U9, Fig. 202**, thus setting the width of bight to one of those shown in **Figs. 198, 199** or **200**.

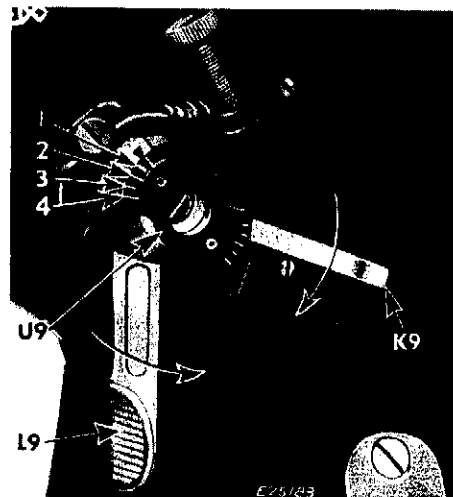

Fig. 202. Bight Control Mechanism (straight stitching)

VARIETIES OF STITCHING AND SUMMARY OF CONTROLS OBTAINABLE FROM BIGHT CONTROL MECHANISM

NO. 1. STRAIGHT STITCH, CENTRAL POSITION

SETTINGS: Bight control lever **K9** at **lowest** point (ZERO BIGHT) and position lever **L9** at **lowest** point (CENTRAL POSITION), as shown in **Fig. 202**.

STITCHING: Straight stitching **midway between two extremes of maximum bight**, as shown in **Fig. 203**.

CAUTION: A machine equipped with **straight stitching** throat plate and presser foot **must always be set as described above**. See **Fig. 202**.



Fig. 203

However, this type of stitch as well as all of those listed below and on **pages 98 and 99** can be accomplished on a machine equipped for zigzag stitching.

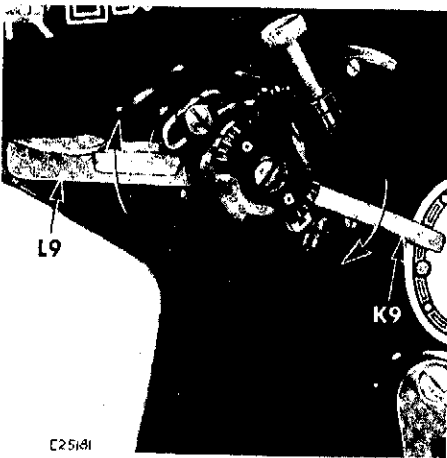

Fig. 204

NO. 2. STRAIGHT STITCH, LEFT-HAND POSITION

SETTINGS: Bight control lever **K9** at **lowest** point and position lever **L9** at **highest** point as shown in **Fig. 204**.

STITCHING: Straight stitching at the **extreme left-hand** position of the needle. See **Fig. 205**.



Fig. 205

NO. 3. STRAIGHT STITCH BETWEEN LEFT AND CENTRAL POSITION

SETTINGS: Bight control lever **K9** at **lowest** point and position lever **L9** at any one of the **infinite number of settings between the central and the left-hand** positions of the needle, as shown in **Fig. 206**.

STITCHING: Straight stitching on one of the infinite number of lines between the extreme left and center positions of the needle. See **Fig. 207**.

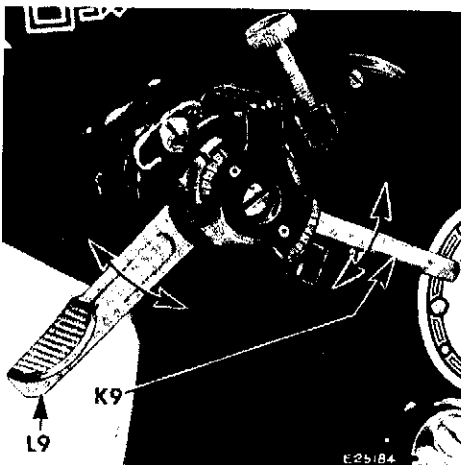

Fig. 206

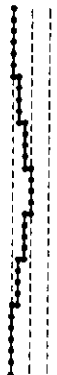

Fig. 207

NO. 4. MAXIMUM ZIGZAG STITCH, CENTRAL POSITION

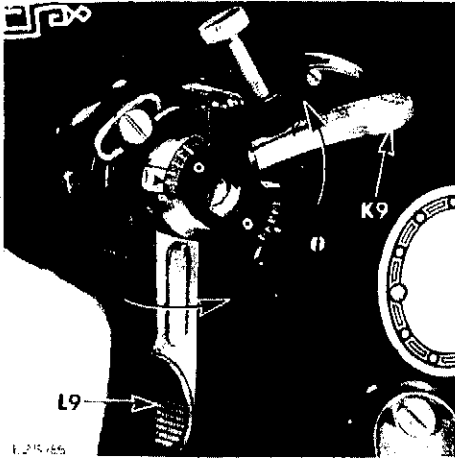

Fig. 208

SETTINGS: Right control lever **K9** at **highest** point and position lever **L9** at **lowest** point, as shown in **Fig. 208**.

STITCHING: Zigzag stitching performed at the maximum width possible, the needle swinging equally to the right and to the left of the central needle position, as shown in **Fig. 209**.

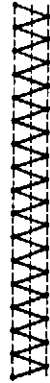

Fig. 209

NO. 5. MAXIMUM ZIGZAG STITCH, LEFT-HAND POSITION

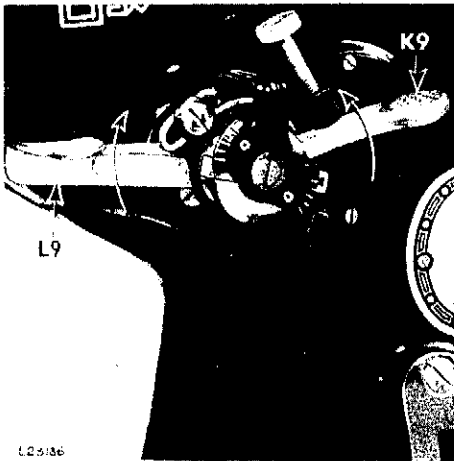

Fig. 210

SETTINGS: Right control lever **K9** at **highest** point and position lever **L9** at **highest** point as shown in **Fig. 210**.

STITCHING: Zigzag stitching performed at the maximum width possible, the needle swinging from the extreme left hand position toward the extreme right as shown in **Fig. 211**.

NOTE: When the right control lever **K9** is set at maximum right as described in the last two types of stitching, the **appearance** of the stitching **should remain the same** whether position lever **L9** is set at its **highest** or **lowest** point or at any other setting in between these extremes. Compare the stitching in **Figs. 209** and **211**.

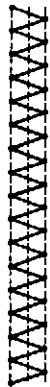

Fig. 211

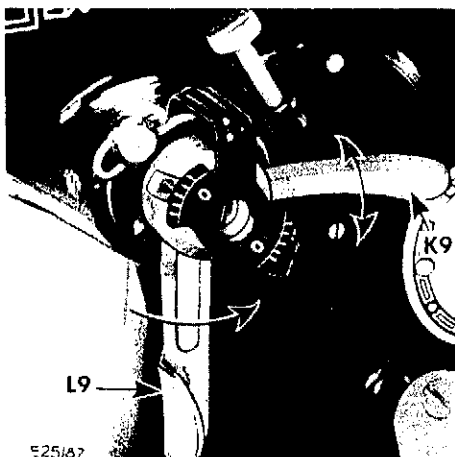

Fig. 212

NO. 6. ZIGZAG STITCH OF VARIOUS WIDTHS CENTRAL POSITION

SETTINGS: Right control lever **K9** at any desired setting **between lowest and highest** point and position lever **L9** at **lowest** point, as shown in **Fig. 212**.

STITCHING: Zigzag stitching performed at width desired up to maximum right, the needle swinging equally to the right and to the left of the **central position**. Variations of this stitching are shown in **Fig. 213**.



Fig. 213

NO. 7. ZIGZAG STITCH OF VARIOUS WIDTHS, LEFT-HAND POSITION

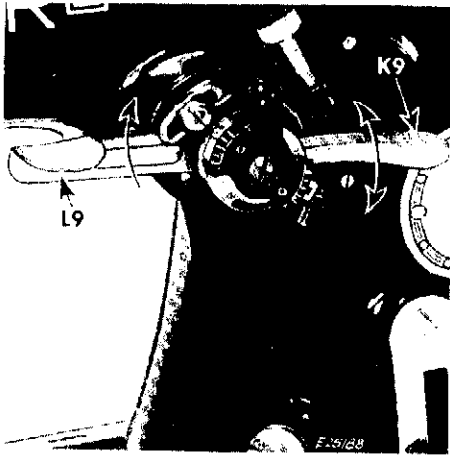

Fig. 214

SETTINGS: Bight control lever **K9** at any desired setting **between lowest and highest** point and position lever **L9** at **highest** point, as shown in Fig. 214.

STITCHING: Zigzag stitching performed at width desired up to maximum bight, the needle swinging from the extreme left toward the right. Variations of this stitching are shown in Fig. 215.

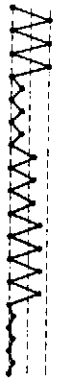

Fig. 215

NO. 8. ZIGZAG STITCH OF VARIOUS WIDTHS AND AT VARIOUS POSITIONS OF THE NEEDLE

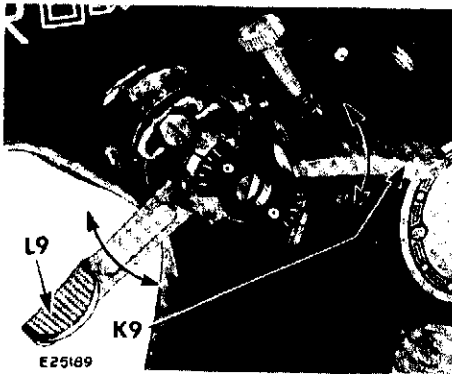

Fig. 216

SETTINGS: Bight control lever **K9** and position lever **L9** at any position **between highest and lowest** point as shown in Fig. 216.

STITCHING: Zigzag stitching performed at width desired up to maximum bight, the needle swinging from various positions at the left of the central position toward the right. An example of this very irregular zigzag stitch is shown in Fig. 217.

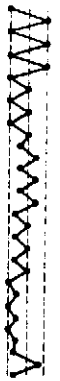

Fig. 217

TO REMOVE THE BIGHT CONTROL MECHANISM

To remove the bight control mechanism, move bight control lever **K9**, Fig. 218 and position lever **L9** toward each other. Loosen two screws **V9** and slide entire assembly out of machine arm.

If necessary, disassemble the mechanism as illustrated in Fig. 219.

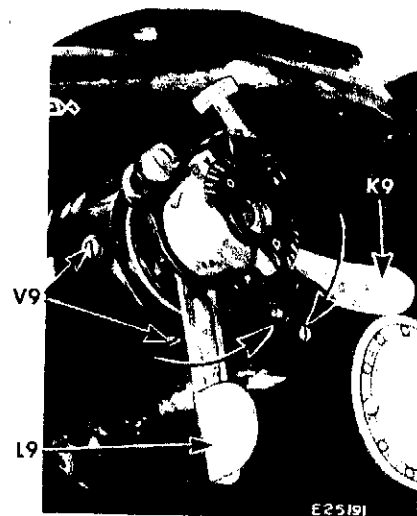

Fig. 218. Removing Bight Control Mechanism

SUB-ASSEMBLY ARRANGEMENT

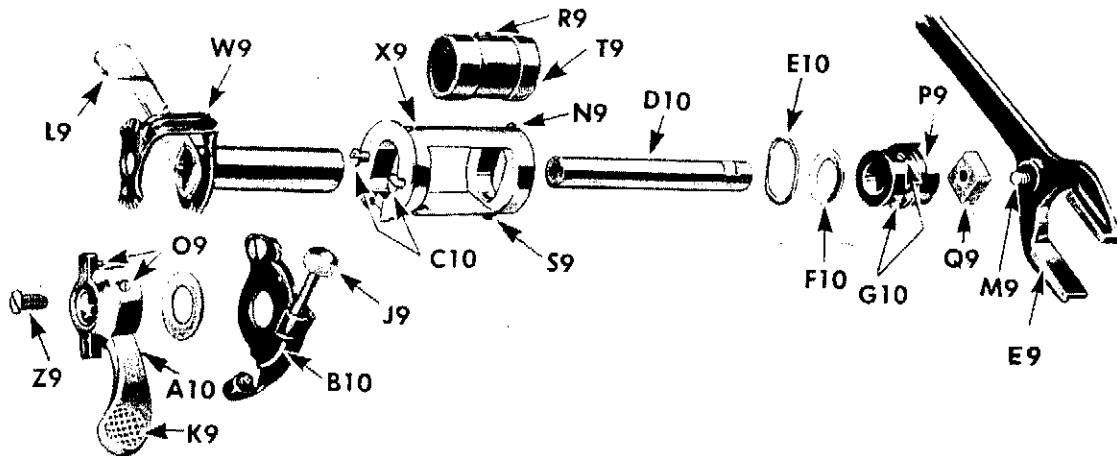

Fig. 219. Exploded View of Bight Control Mechanism

NOTE: Stud **M9** and connection fork **E9** need not be removed from machine when removing bight control mechanism.

Ref.	Part No.	Ref.	Part No.	Ref.	Part No.
E9	189600	P9	188416	Z9	691
J9	183025	Q9	188415	A10	189673
K9	189618	R9	453	B10	189616
L9	105001	S9	460	C10	50156
M9	1085	T9	189612	D10	189613
N9	460	W9	105020	E10	188413
O9	624	X9	105022	F10	56038
				G10	624

TO REPLACE THE BIGHT CONTROL MECHANISM

The bight control mechanism should be assembled as illustrated in **Figs. 219** and **220**, bearing in mind the following facts.

Stop pin **A10**, **Fig. 219** on the bight control lever **K9** must lie **outside** spring **B10**, **Fig. 219** in the assembled device.

When the bight control mechanism is assembled, as shown in **Fig. 220**, tighten screw **Z9**, **Fig. 221** which regulates compression of spring washer **F10**, **Fig. 219** just enough to allow operation of levers **K9** and **L9**, **Fig. 221** without shifting during sewing.

Turn set screws **N9**, **Fig. 221** and **S9**, **Fig. 220** inward until flush with outer surface of sleeve **X9**, **Fig. 220**.

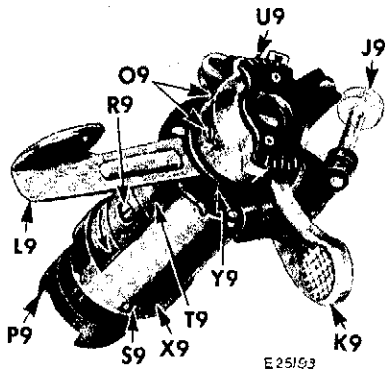

Fig. 220. Rough Adjustment of Bight Control Mechanism

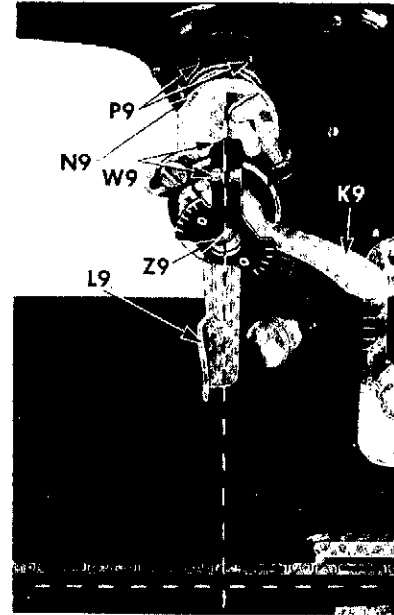

Fig. 221. Setting of Bight Control Mechanism During Installation

Turn eccentric **T9**, **Fig. 220** as far as possible in the direction of arrow. Move position lever **L9** downward until it clears the stop **Y9**, **Fig. 220** by approximately 1/32 inch. Then securely tighten set screws **N9**, **Fig. 221** and **R9**, **Fig. 220**.

Move position lever **L9** to its highest point and securely tighten set screw **S9**, **Fig. 220**.

Move levers **K9** and **L9** to their lowest points and rotate slideway **P9**, **Fig. 221** until it is parallel to a line through the centers of the bight control scale bridge **W9**, adjusting screw **Z9** and position lever **L9**, as shown in **Fig. 221**. Securely tighten set screws **O9**, **Fig. 220**.

Apply heavy grease to slide **P9**, **Figs. 220** and **221**. Then set slide block **Q9**, **Fig. 219** into slide **P9** so that the grease holds block.

Hold bight control mechanism so that the line through the centers of the bridge **W9**, adjusting screw **Z9** and position lever **L9**, described above is approximately perpendicular (\perp) to the bed of the machine as shown in **Fig. 221**. Slide assembly into machine arm while simultaneously guiding slide block **Q9**, **Fig. 222** onto stud **M9**. Tighten stud **M9**. Then securely tighten set screws **V9**, **Fig. 223**.

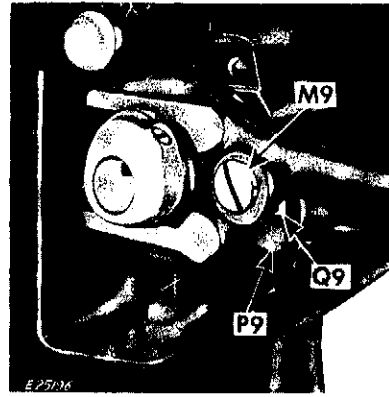

Fig. 222. Vibrator Fork Connection and Regulating Slide Block

TO ADJUST THE BIGHT CONTROL MECHANISM AT ZERO BIGHT (STRAIGHT STITCHING)

When the machine is set at zero bight, with bight lever **K9**, **Fig. 223** at the lowest position, there must not be any vibration or zigzag movement of the needle. If needle vibrates, a radial adjustment may be needed as described below.

RADIAL ADJUSTMENT FOR ZERO VIBRATION DURING STRAIGHT SEWING

To adjust position of bight control mechanism at zero bight (removing all vibration of the needle during straight sewing) loosen set screws **V9**, **Fig. 223** and turn entire mechanism clockwise or counter-clockwise as required.

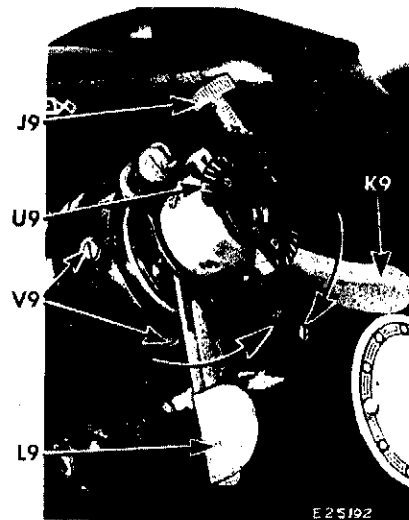
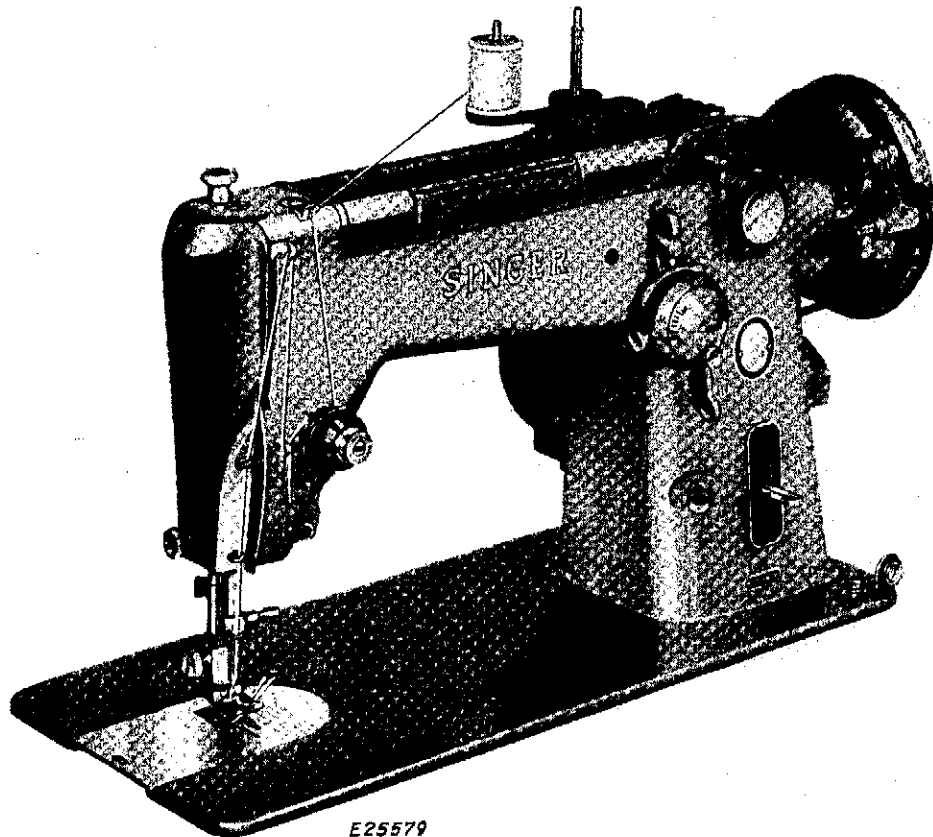

Fig. 223. Adjusting Zero Bight

NOTE: If **all** vibration of the needle, during straight sewing, cannot be eliminated by a **slight radial adjustment** as described above, return the

mechanism to the perpendicular (\perp) position, as instructed above, and check entire bight control mechanism as instructed on **pages 91 to 95**.

SINGER AUTOMATIC SWING-NEEDLE MACHINES OF CLASS 319



E25579

Fig. 224. Machine 319w2

The instructions on pages 1 to 79 generally apply to Class 319 Automatic Swing-Needle Machines.

Specific instructions which apply only to Machines of Class 319 appear on pages 105 to 123.

)

)

)

**DIFFERENCES IN BOBBIN CASE HOLDERS AND
BOBBIN CASES OF MACHINES 306 AND 319**

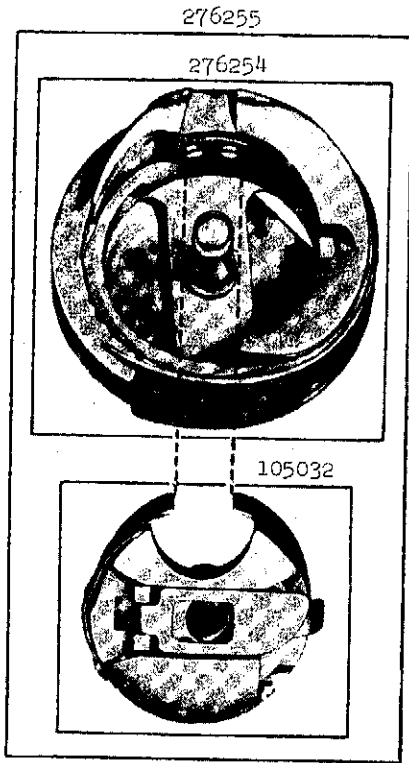
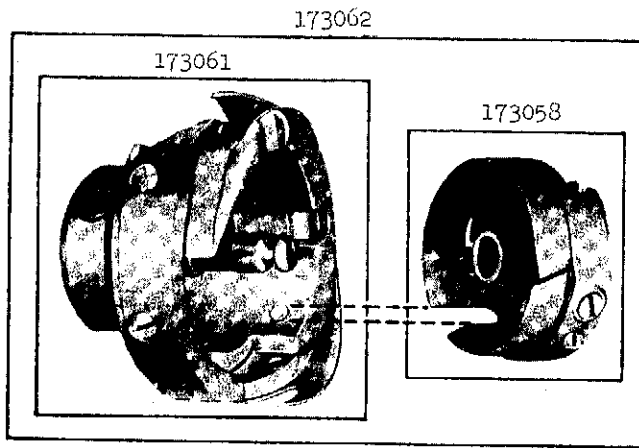

Fig. 225. Bobbin Case Holder and Sewing Hook of Machine 306

Fig. 226. Bobbin Case of Machine 306

306



319

**Fig. 227
Bobbin Case Holder and Sewing Hook of Machine 319**

**Fig. 228
Bobbin Case Machine 319**

TO REMOVE ARM SHAFT CONNECTION BELT FROM WITHIN THE ARM

To remove arm shaft connection belt proceed as follows:

Remove needle from needle clamp.

Slide the connection belt **A3**, **Fig. 229** to the left on lower sprocket **A2**, then loosen the two sprocket screws **A4** and slide the sprocket to the extreme left and slide belt to the right and over edge of sprocket as illustrated in **Fig. 230**.



Fig. 229. Lower Sprocket

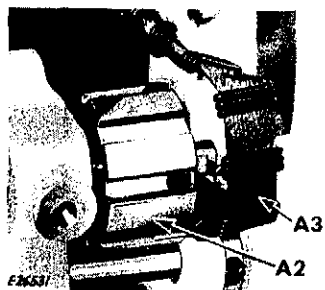

Fig. 230. Removing Belt

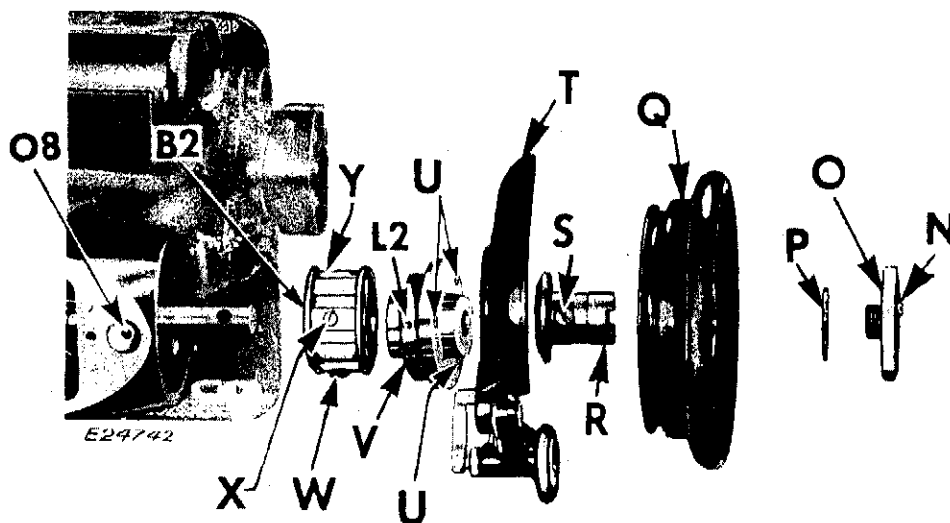

Fig. 231. Removing and Replacing Arm Shaft Connection Belt

Loosen stop motion stop screw **N**, **Fig. 231** and remove the following parts:

Clamp screw **O**

Washer **P**

Hand wheel **Q**

Flanged bushing screw **S** and bushing **R**

Three arm shaft bushing screws **U** with bobbin winder **T** complete

Arm top cover

Raise levers

Lift belt to left of arm shaft sprocket and loosen sprocket screws **X** and **W**, **Fig. 231** so that heads of screws are flush with surface of sprocket.

Press oil wick down at **O8** so that it will not interfere when removing rear arm shaft bushing **V**.

To remove arm shaft bushing **V**, press fingers against sprocket to ease sprocket and bushing out until bushing is free from bearing in casting. (If bush-

ing resists finger pressure, use 5/16 inch brass drift punch against side of sprocket to ease bushing past arm bearing.)

Remove sprocket **Y**.

NOTE: Purchase 5/16 inch brass rod at local hardware and mill supply store.



Fig. 232. Drawing the Belt Out of Arm

Insert finger through arm shaft hole and inside loop of belt. Then snake out belt as shown in **Fig. 232**.

TO REPLACE ARM SHAFT CONNECTION BELT



Fig. 233.
Inserting Belt into
Arm Shaft Hole

With seam clips on inside of belt, form loop with belt and slide along shaft as shown in Fig. 233. Grasp belt with left hand as shown in Fig. 234 and pull belt through top of arm until bottom of belt clears arm shaft hole. Then drape upper half of belt over arm as shown in Fig. 235.

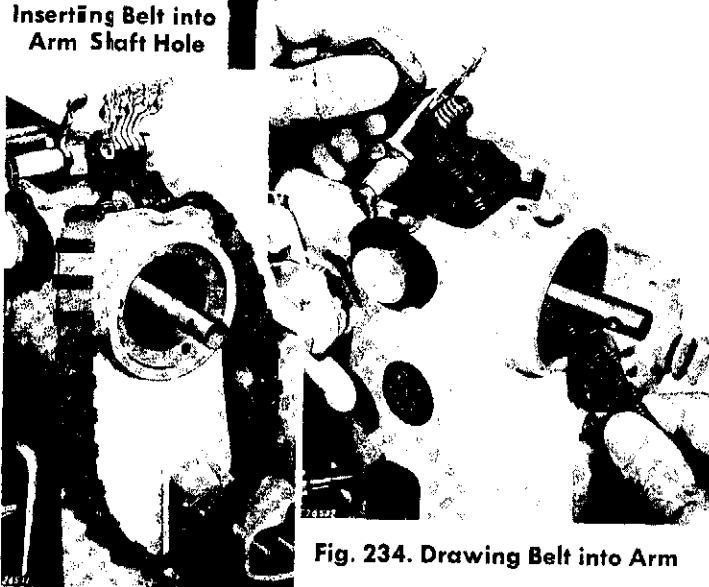

Fig. 234. Drawing Belt into Arm

Fig. 235. Draping Belt over Arm

Slide sprocket on to arm shaft with **timing notch**, atop flange edge, facing take-up lever end of machine. Locate set screw nearest notch on flat of arm shaft and fasten screw **X**, Fig. 236 lightly.

NOTE: To avoid bending arm shaft, do not tighten sprocket screws as long as arm shaft is unsupported. Permanent tightening of screws should be delayed until hand wheel is mounted.

To insure sufficient clearance for heat expansion between sprocket and rear arm shaft bushing, sprocket must be located as close to the bank of cams as is possible without high points of cams striking or rubbing against flange of sprocket. For maximum clearance use two strips of letter paper, as illustrated in Fig. 236, to make sure that high points of cams do not interfere. This clearance should be checked for at least ten (10) complete turns of the hand wheel.

Slide bushing along arm shaft, making sure that oil hole **L2**, Fig. 231 at top of the bearing is in alignment with oil hole **08**, Fig. 231 at top of arm.

If arm shaft bushing resists finger pressure, make sure there are no burrs along bearing edge. A few light strokes of a file or a light dressing down with very fine emery cloth will help to ease bushing into place.

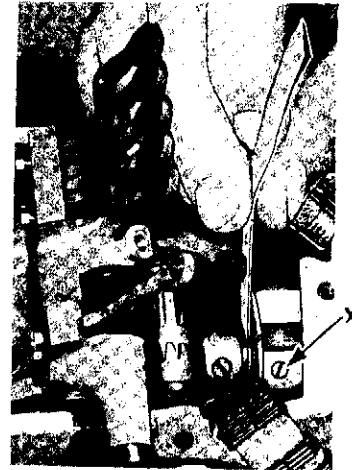

Fig. 236. Locating Sprocket
in Relation to Gear

Mount bobbin winder complete so that screws barely pinch. Insert third bearing screw until it pinches. Then progressively tighten each screw a slight amount until all screws are tightened firmly.

CAUTION: If each screw is tightened individually rather than gradually, arm shaft will bind or machine will run slowly.

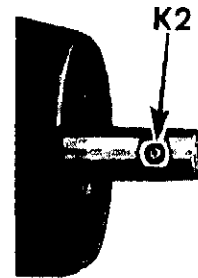

Fig. 236A. Screw Seat Near End of Arm Shaft

One end of screw hole **K2**, Fig. 236A near end of arm shaft has a seat for hand wheel bushing screw **S**, Fig. 33. This seat, like the large hole in the hand wheel bushing, must be in the uppermost position to properly fasten bushing in place. Drop screw **S** into screw hole and, just before fastening bushing in place, slide .020 inch Feeler Gauge No. G34203 between bearing and bushing. Push bushing against gauge and then lock the screw in position. This method of locating bushing will insure adequate heat expansion clearance—.020 inch as illustrated in Fig. 33. If more clearance is needed, try .022 to .024 inch.

To time feed, see **page 29** for details.

TO SET THE FEED DOG AT THE CORRECT HEIGHT

To check the height of the feed dog, tighten feed throw thumb screw **O2**, **Fig. 239**, turning it clockwise as far as possible. Then set the stitch regulator **X2**, **Fig. 43**, page 33 for the longest stitch.

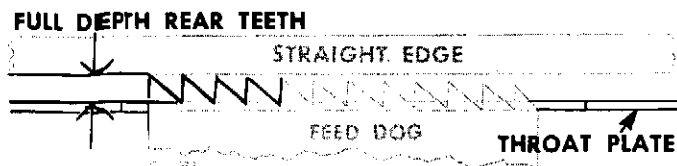

Fig. 237. Feed Dog at Correct Height

Turn the hand wheel over toward you until the feed dog is raised to its highest point. In this position, the full depth of the rear teeth of the feed dog, farthest from operator, should project above the top surface of the throat plate, as shown in **Fig. 237**. Gauge No. G34202 for setting correct feed dog height is shown in use in **Fig. 238**.

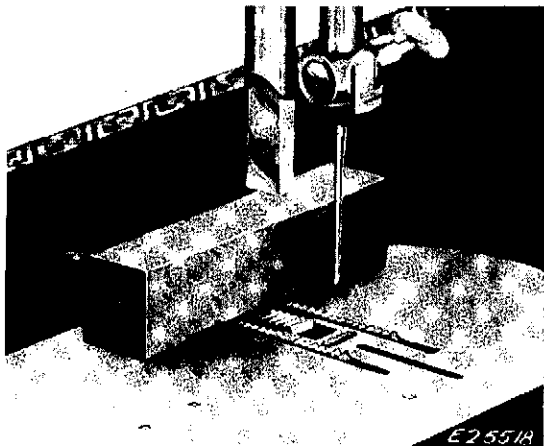

Fig. 238. Feed Dog Height Being Checked with Gauge

Be certain feed dog does not "kick back," as it rises. If it should "kick back," lower feed dog slightly.

To set the feed dog at the correct height, loosen clamping screw **P8**, **Fig. 239** and raise or lower the feed dog **Q2**, **Fig. 239** as required. Then securely tighten clamping screw **P8**.

NOTE: The feed lifting eccentric is timed to lift feed dog at a particular time in the stitch formation process. For this reason it is not adjustable and is fixed by location of the upper fillister head screw on the flat of the hook driving shaft.

For quick reference, the relative location of gear, eccentrics and sprocket is illustrated in **Fig. 240** to show which screw correctly locates each part on the hook driving shaft.

On occasion, screw **P2** will be loosened to raise or lower feed dog height. In so doing it is possible to inadvertently create end play in the sub-assembly, thus causing noise and binding troubles. Also it is difficult to correctly adjust the feed dog height by this means because in tightening the screw, the feed dog will be lowered instead of maintaining its height.

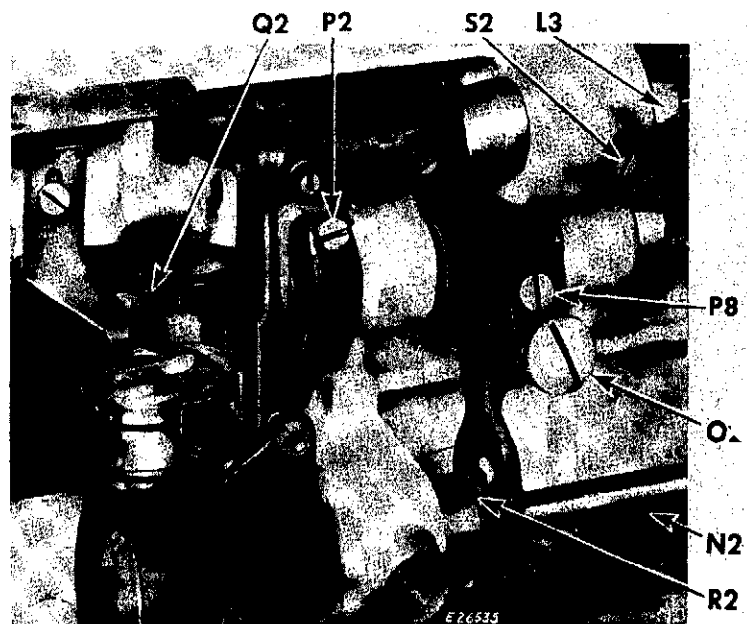

Fig. 239. Adjusting Height of Feed Dog

Screw **P2** should be used only to take up end shake or relieve binding that may exist between crank and collar in feed lifting sub-assembly. When making this adjustment, hold crank and collar gently between fingers.

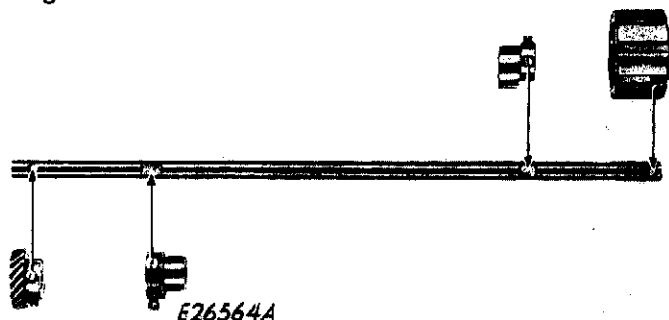

Fig. 240. Location of Gear, Eccentrics and Sprocket on Hook Driving Shaft

TO REMOVE BINDING IN THE FEED CONNECTION ASSEMBLY

1. Turn out feed regulator stop screw **S7**, Fig. 241 to permit maximum up and down movement of stitch regulator.
2. Loosen slide bar nut **S5** with Wrench #255539. By means of a small screwdriver **S3** turn eccentric slide bar **S6** clockwise about 1/8 of a turn with left hand. Then with right hand move stitch regulator up and down to test for stickiness or
- binding. Repeat the 1/8 turn and stitch regulator test until all evidence of stickiness is eliminated.
3. Then turn hand wheel 1/8 of a turn at a time and repeat the test in Step 2 until free action is found in every position of the feed cycle.
4. Hold slide bar position carefully while tightening nut **S5**.

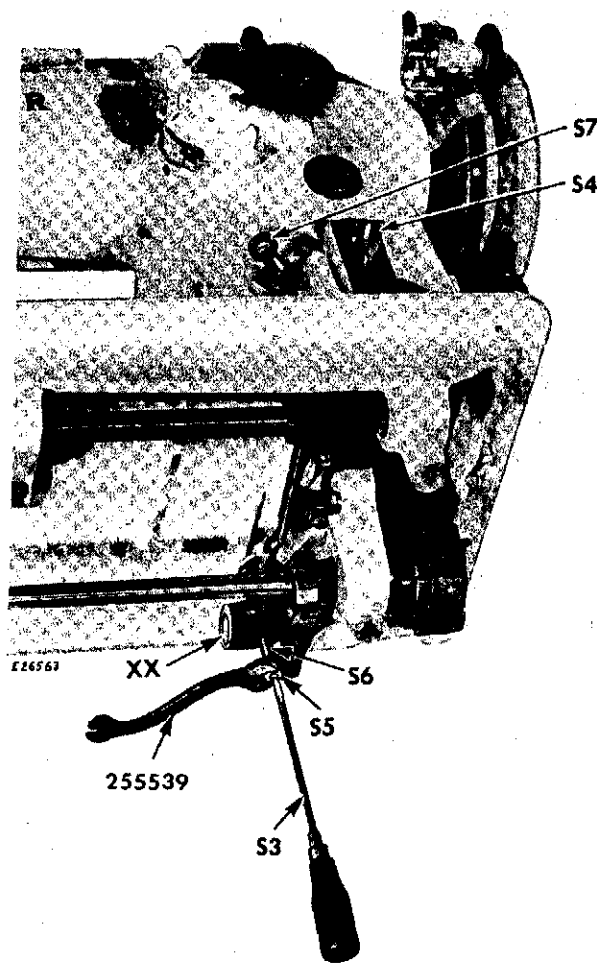

Fig. 241

TO REMOVE HOOK DRIVING SHAFT

1. Remove cover from gear case.
2. Loosen sprocket screws **C4**, Fig. 242.
3. Loosen feed eccentric screws **W3** and **Z3**.
4. Ease shaft to the left until lower sprocket with belt is free.
5. Continue to push shaft with a rocking spiral motion until both eccentrics are free of the shaft.
6. Pull shaft out of gear case.
7. Save grease† unless it is contaminated.

TO REPLACE HOOK DRIVING SHAFT

1. Insert hook driving shaft into gear case bearing.
2. Slide shaft to the right and mount feed lifting eccentric **R2**, Fig. 51, page 38 with collar adjacent to bearing **Y3**.
3. Mount feed advance eccentric with collar **A4**, Fig. 242. Collar must be set close to fork without rubbing against jaw of fork to avoid binding of machine from heat expansion.
4. Pass shaft through rear bushing **B4** and enter lower sprocket.

CAUTION: To locate eccentrics and sprocket properly, refer to Fig. 243.

5. Repack gear case as instructed on page 123.
6. Replace cover on gear case and fasten with two screws.
7. Check belt on both sprockets in accordance with the instruction on timing the feed on page 29.

NOTE: To avoid binding at end of bushing **B4** and sprocket **J2**, due to heat expansion, see Fig. 56, page 40.

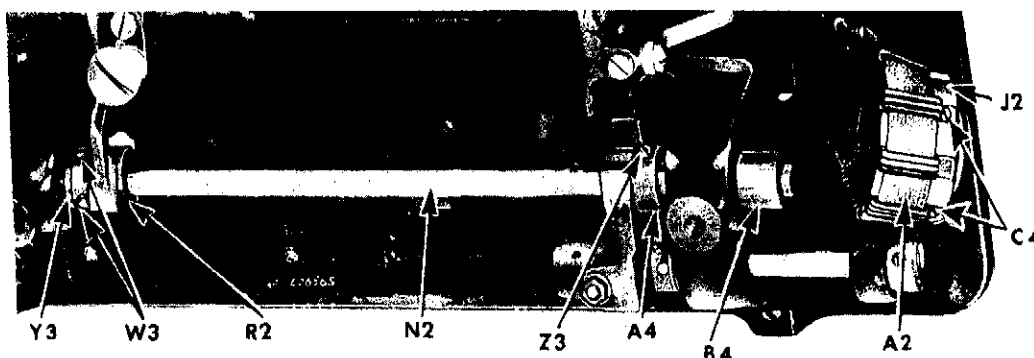

Fig. 242. Removing Sprocket and Hook Driving Shaft

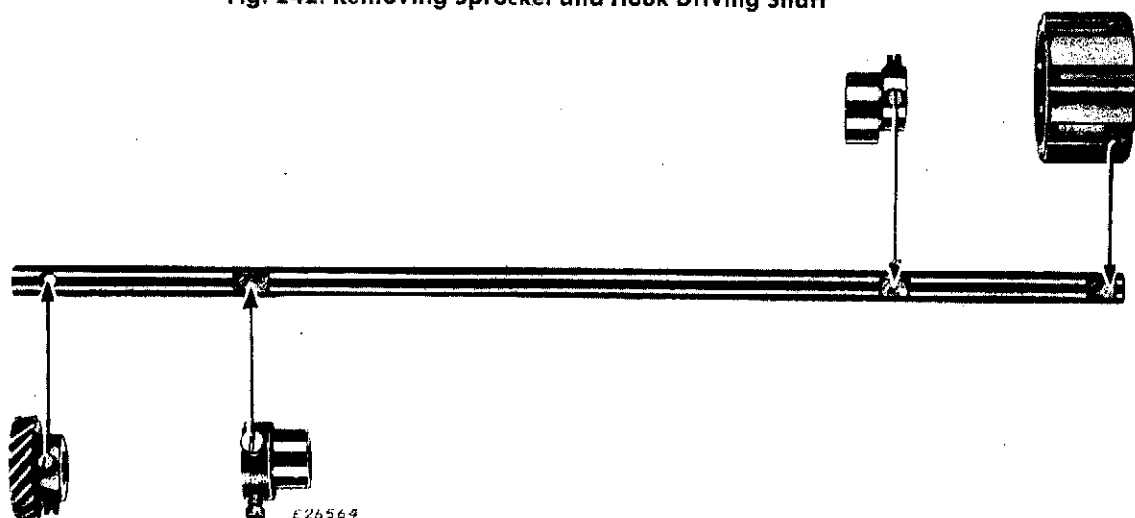

Fig. 243. Location of Gear, Eccentrics and Sprocket on Hook Driving Shaft

† If new grease should be needed, use tubed grease No. 121915.

ADJUSTMENT FOR THREAD CLEARANCE BETWEEN POSITION FINGER AND BOBBIN CASE BASE

The thread clearance between the position finger **O4** and the bobbin case base **P4**, **Fig. 244** must be set at approximately .020 inch, so that there is free passage for the upper and under threads while the loop of needle thread is being passed around the bobbin case. There may be a tolerance of .002 inch deviation in either direction from approximately .020 thread clearance.

To check thread clearance, use feeler gauge No. G34203, as shown in **Fig. 244**.

If bobbin case shows a weaving motion, it may be necessary to increase thread space to .022 inch.

To adjust the position finger for proper clearance, loosen the screw **N4** and move the finger toward the front or rear, as required, then securely tighten screw **N4**.

TO SET THE NEEDLE BAR HEIGHT INDICATOR

To set the needle bar height indicator, **Q4**, **Fig. 245**, turn the hand wheel over toward the operator until the needle bar is at its lowest position. Loosen screw **R4** and move indicator **Q4** up or down, as required, so that gauge line corresponds with the upper timing mark **T4** of needle bar. Then securely tighten screw **R4**.



Fig. 244. Adjusting Position Finger

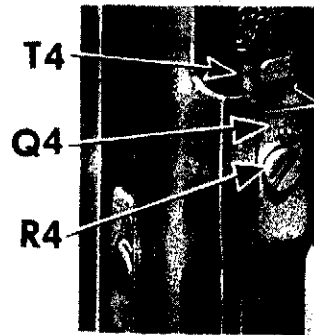

Fig. 245

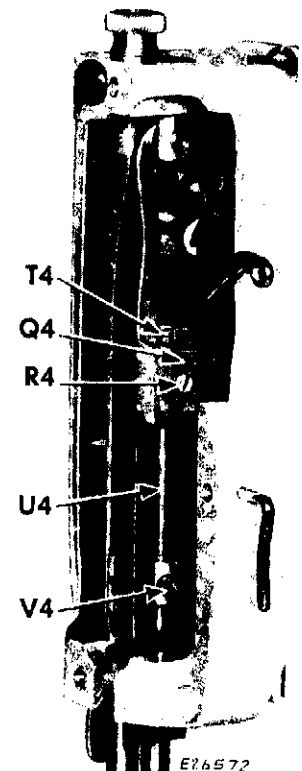

Fig. 246. Upper Timing Mark on Needle Bar

TO INSTALL BIGHT CONTROL MECHANISM

NOTE: The two bearing surfaces of the slide **S5** and slide block **W6**, Fig. 247 can be easily detected by their brightness and smoothness in comparison with non-bearing surfaces.

Before installing bight control mechanism in machine arm, make certain that the two bearing surfaces of the slide block **W6** will engage the two bearing faces of the bight control slide **S5**, Fig. 249.

Mount the spring retainer plate **Y6**, Fig. 247 on the bight control slide **S5** with two retainer screws **Z6**. Make certain that the spring prong **U5** is toward the open side of the bight control slide **S5**.

Set both control levers **G5** and **H5** at neutral position, as shown in Fig. 248, and slide entire assembly into arm.

By a slight rotary movement toward left or right, engage slide block **W6**, as shown in Fig. 249.

In some instances it will be necessary to move pitman back and forth and turn hand wheel until slide engages slide block.

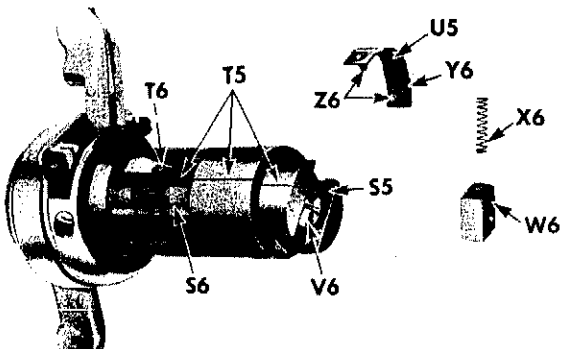

Fig. 247. Aligning Eccentric and Slide with Bearing Sleeve

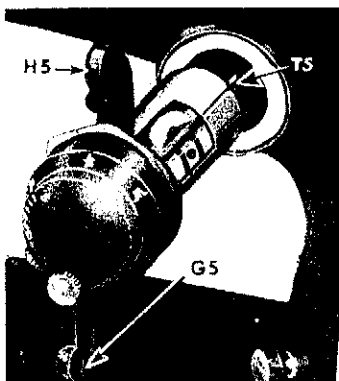

Fig. 248. Installing Bight Control Mechanism

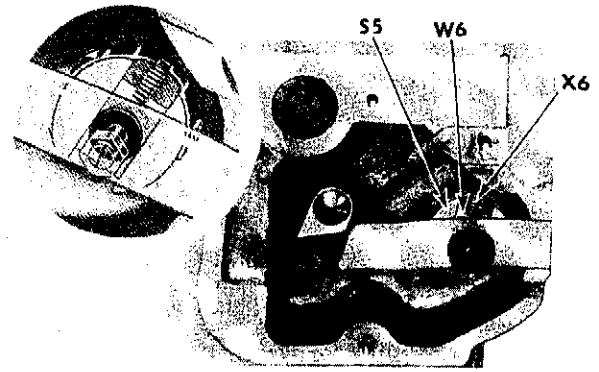

Fig. 249. Pitman and Regulating Slide Block

In some stubborn cases, a mirror is helpful in engaging slide block.

After the slide block **W6**, Fig. 249 is engaged in the bight control mechanism, the spring **X6**, Fig. 249 is inserted into the hole in the slide block; this is done with the aid of a small screwdriver by compressing and positioning over the spring prong **U5**, Fig. 247 on the retainer plate **Y6**, Fig. 247.

While maintaining the position of levers **G5** and **H5** in neutral, rotate the hand wheel by hand and check for needle vibration. If needle vibrates, rotate the entire bight control unit toward the right or left until vibration at straight stitching is eliminated. Then tighten the two set screws **X5**, Fig. 250. See page 60 to eliminate needle vibration with a bight gauge.

Adjust bight controls in the same order as instructed on pages 60 to 63.

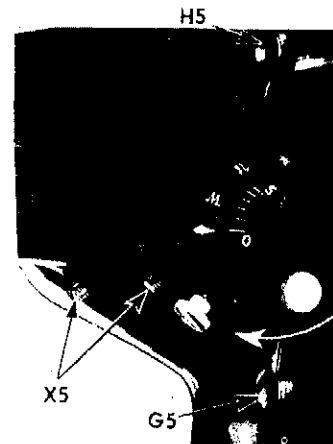

Fig. 250. Positioning Bight Control Mechanism

TO REMOVE THE DISC SELECTORS FROM FOLLOWER FRAME

The follower frame is shown removed from machine only for the purpose of enlarged illustration.

CAUTION: To avoid loss of disc selector locking pin springs, loosen screws equal in sequence, until complete pressure is removed from the disc selector retainers **B3** and **B7**.

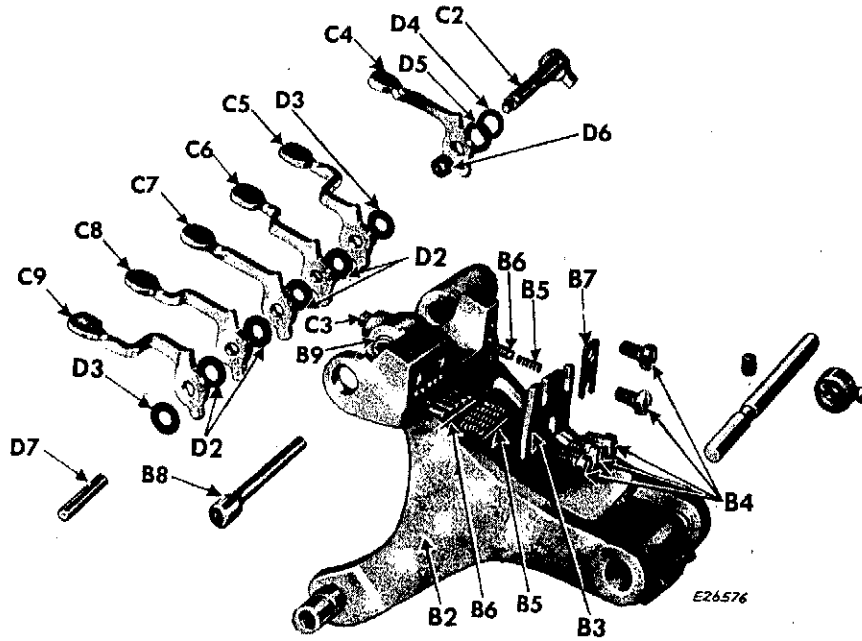

Fig. 251

1. Remove:
 - (a) Three disc retainer screws **B4**, Fig. 251 and retainer **B3**.
 - (b) Five disc selector locking pin springs **B5**.
 - (c) Five disc selector locking pins **B6**.
2. Loosen disc selector stud set screw **C3** and remove selector stud **B8** and spring **B9**. This will release the marked selectors and washers.
3. Remove:
 - (a) Two disc retainer screws **B4** and retainer **B7**.
 - (b) Disc selector locking pin spring **B5**.
 - (c) Disc selector locking pin **B6**.
4. Remove:
 - (a) Disc selector stud nut **D6**.
 - (b) Disc selector **C4**.
 - (c) Disc selector stud friction washer **D5**.
 - (d) Disc selector stud washer **D4**.
 - (e) Disc selector stud **C2** from follower frame.

TO REPLACE THE DISC SELECTORS ON THE FOLLOWER FRAME

The disc selectors should be mounted on the follower frame in the following manner:

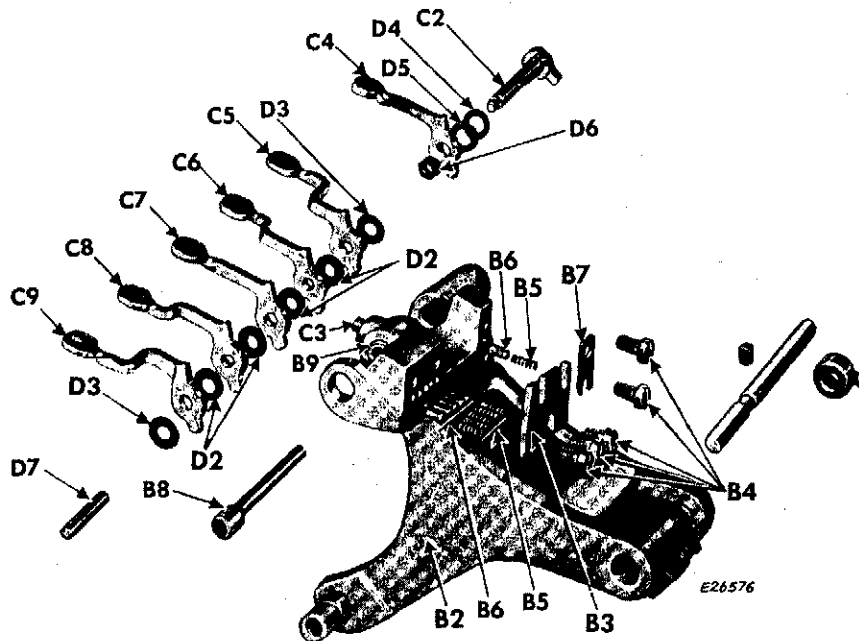

Fig. 252

1. Insert selector stud spring **B9** in the follower frame **B2**.
2. Pre-assemble selector levers with washers on Guide Pin (Tool No. T4346) **D7**, in the order given in **Fig. 252**.
CAUTION: Spacing washers **D3** are thin washers and belong on **each** end of the assembly.
3. Place the pre-assembled disc selectors into the space in front of stud spring **B9**, **Fig. 252**.
4. Then guide the selector stud **B8** into the follower frame, gradually easing out the guide pin **D7** until stud protrudes slightly beyond center bearing. Then fasten stud with set screw **C3**.
5. Insert the five disc selector locking pins **B6** (round end toward the selectors) into the follower frame **B2**.
6. Next insert five disc selector locking pin springs **B5** into follower frame.
7. Assemble disc selector retainer **B3** to follower frame with three retainer screws **B4**.
8. Insert disc selector stud **C2** into follower frame, then mount spacing washer **D4** and friction washer **D5** on end of stud as illustrated in **Fig. 252**.
9. Place disc selector (plain) on the square end of the stud and securely tighten selector stud nut **D6**.
10. Insert the disc selector locking pin (round end toward the selector) into follower frame followed by the spring **B5** and assemble retainer **B7** to the frame with two screws **B4**.

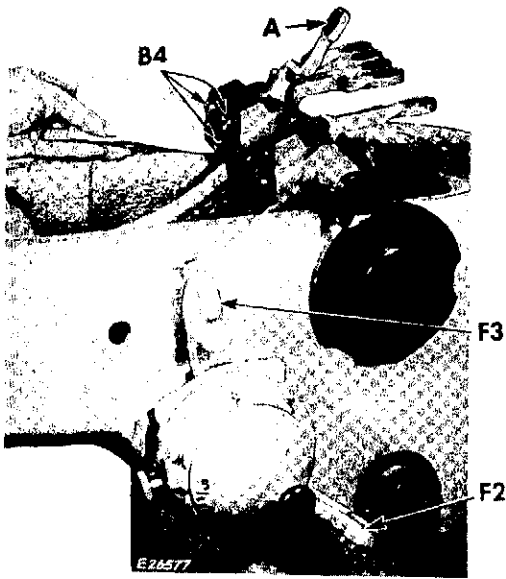

Fig. 253

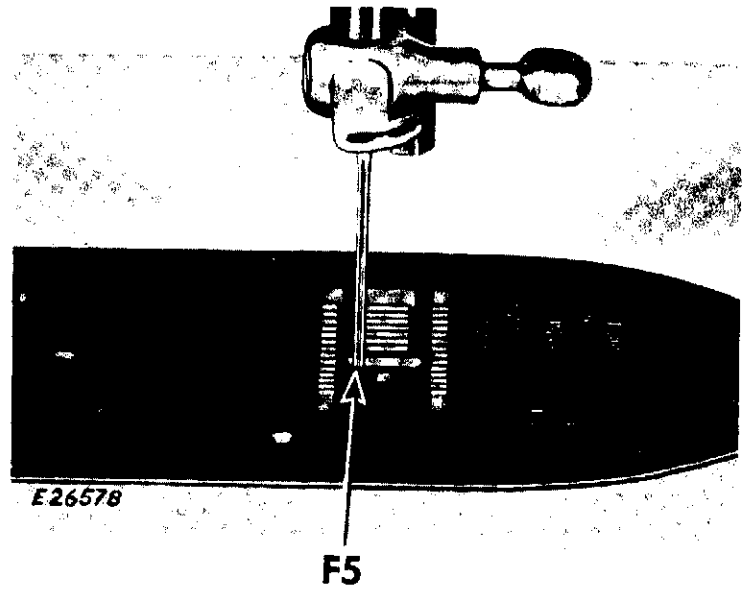

Fig. 254

TO CHECK DISC FOLLOWER FRAME ADJUSTMENT

11. Set bight control lever **F2** at maximum bight, needle position lever **F3** in central position and raise selector lever **A**, as illustrated in **Fig. 253**.
12. Turn hand wheel until cam follower reaches its lowest point. With a single thickness of newspaper check the clearance between selector retainer and top of arm as shown in **Fig. 253**. In this position the paper should slide freely.
13. Set selector lever **A** in down position. Then test for clearance between follower frame and top of arm. Frame should pinch paper.

NOTE: If retainer does not pinch paper, loosen the three screws **B4** and lower retainer until paper is pinched. Tighten screws and recheck clearance.

14. Check clearance of needle in relation to throat plate **F5**. Needle should clear left side of needle slot as illustrated in **Fig. 254**.

TO REMOVE THE STACK OF FASHION DISCS FROM THE MACHINE

Loosen the three arm top cover screws and remove the arm top cover. Loosen the arm side cover thumb screw and remove the side cover. Set all selector levers in up position.

Loosen the two gear screws **K2**, Fig. 255, and the two collar screws **K3**. Then with the locating tool (No. T4345) **K5**, push cross shaft **K4** towards the front of machine until the cross shaft clears the stack of discs **K7**. Hold the stack of discs with the right hand and with the left hand withdraw locating tool. Then with the selectors in a down position, lift follower frame **M2** with the left hand and remove the stack of discs **K7**, meanwhile raising the selectors, then release the follower frame **M2**. The gear **K9** and collar **K8** are left on the cross shaft to remain until reassembly of stack of discs.

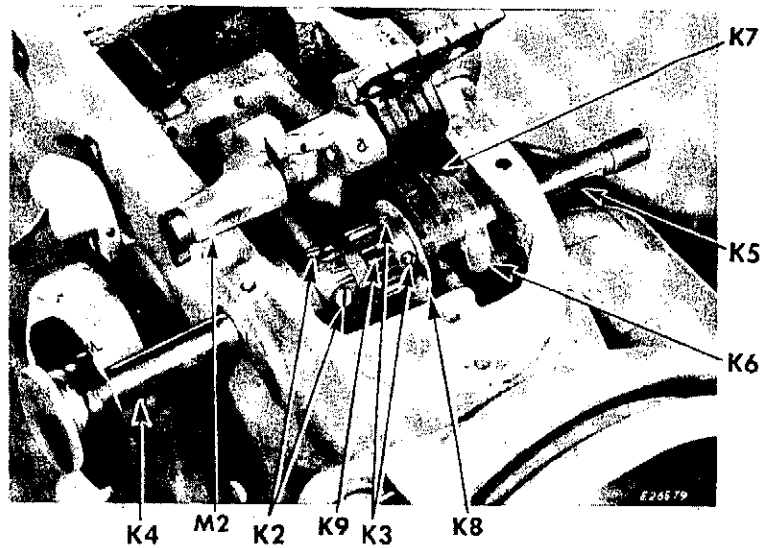

Fig. 255

TO SUBSTITUTE A NEW FASHION DISC

1. With locating tool No. T4345 set in an upright position, mount stack of discs onto locating tool with keys **B4** facing up, as shown in Fig. 255A.
2. Press with thumbs against discs astride the locating tool and press down, as shown in Fig. 255B.
3. Remove from the stack the disc to be replaced and substitute with new counterpart.
4. Then mount discs as described in paragraph 5.

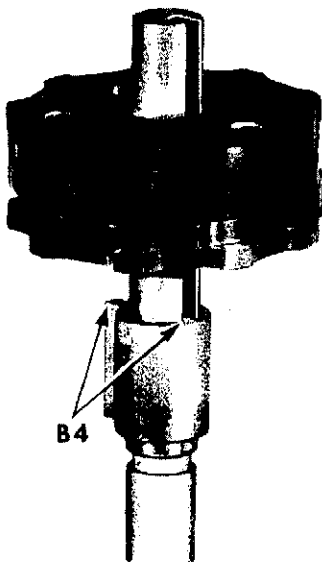

Fig. 255A

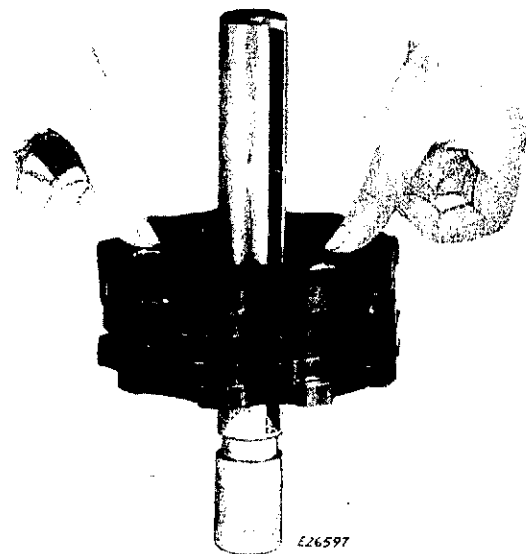

Fig. 255B

TO ASSEMBLE THE STACK OF FASHION DISCS

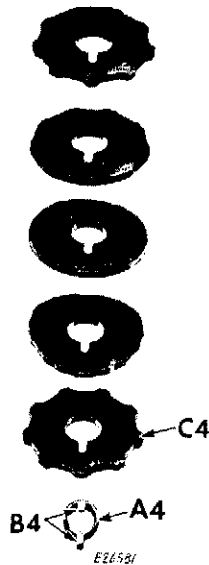

Fig. 256

5. Place the disc bushing **A4**, Fig. 256 in an upright position, with keys **B4** facing up. Then take one disc **C4** at a time and with the STITCH PATTERN DESIGN FACING DOWN, align the key slot with the key on the bushing and press on, as shown in Fig. 255B. This procedure is the same for the remaining discs.

TO REPLACE THE STACK OF FASHION DISCS IN THE MACHINE

Insert the locating tool **K5**, Fig. 255 with slot in upright position through the cross shaft hole in the back of the arm, then place disc washer **K6** on the protruding end of locating tool inside the arm.

With selector levers raised, hold stack of discs so that key in stack cam bushing is in the uppermost position. Then insert the stack of discs **K7** with zigzag disc facing right control levers.

With selector levers in a down position, lift follower frame **M2** with the left hand and gradually work cam stack into position with the right hand. Then release follower frame **M2**, raise the selectors and push

locating gauge **K5** towards right control levers until it clears stack of discs. Mount second disc washer **K6** on the protruding end of locating tool.

With one hand hold locating tool with slight pressure, gradually turn and press cross shaft against cam stack; with the other hand engage stack and slowly eject locating tool.

Position and securely tighten the two collar screws **K3** tightly against disc washer **K8**.

To correctly time pendulum movement of needle, one of the cross shaft gear screws should just pinch until gear position is set as described on page 54.

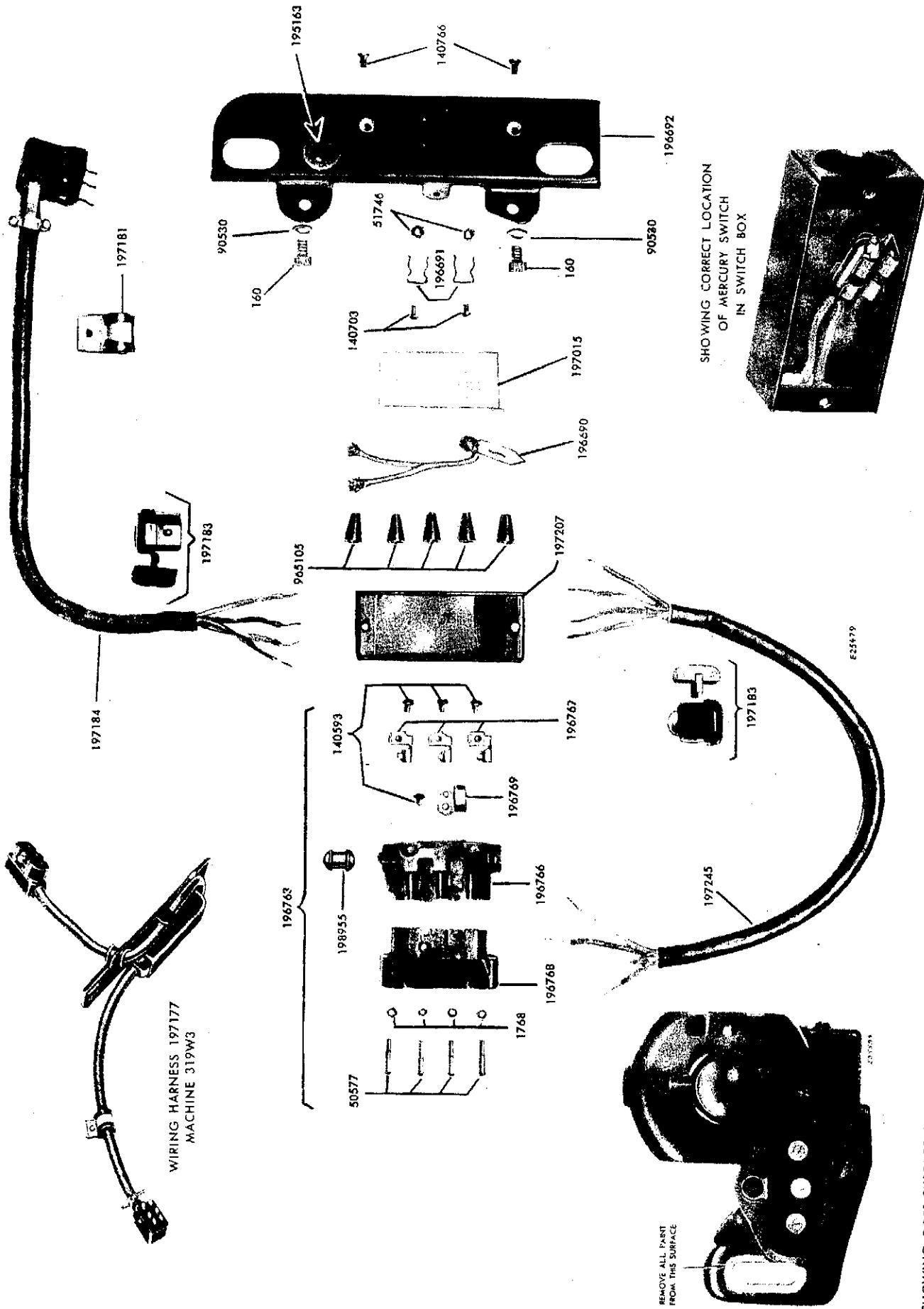

Fig. 257. Parts Chart showing Wiring Harness Complete No. 197177 for Machine 319W3 on School Tables 417, 418 and 419.

SHOWING BOSS SURFACE AROUND SCREW HOLE ON 319W3 MACHINE MOTOR BRACKET WHICH MUST BE CLEANED FOR GROUNDING.

WHEN DISC FOLLOWER FRAME SEEMS TO BE NOISY

Noise, in its various forms, is usually caused by improperly adjusted parts. The parts may be loosely fitted or they may be binding. Follow the sequence of check-points to eliminate operating noise:

1. Test arm shaft for end-play. Take up looseness with front arm shaft collar. Check for a loose clamp Stop Motion Bushing, #45311.

2. Check for end-play in cross shaft. Take up all play by setting gear against side of arm.

3. Check outside disc for looseness on cross shaft. Tighten thumb nut securely.

4. Lift disc follower frame with the left hand to relieve pressure on cam stack. With right hand, test cross shaft at thumb nut for back lash between gears. If play between gear teeth appears excessive, replace cross shaft gear.

5. Hold Cross shaft thumb nut with left hand and with right hand test cam stack for looseness. Check for play at:

(a) Cam stack collar #173003 too far away from discs.

(b) No. 1 or No. 5 disc loose on cam bushing.

(c) Disc bushing, #173014 loose on cross shaft. Replace loose components.

6. If disc follower frame hinges freely (up and down), loosen collar on hinge pin and move frame (forward or backward)—from a very free position to a position where frame begins to drag slightly. This adjustment will take up any slack motion in the assembly.

NOTE: Make sure cam followers do not ride two discs or interfere with wall of adjacent disc.

7. If all the items noted are in good order, disconnect needle bar frame at its lowest extremity and slightly stretch compression spring, #173048 or install a new spring.

Occasionally, the bight control slide block spring may not exert sufficient spring pressure in which case a new spring should be inserted.

8. Check for interference between rear arm side cover and needle vibrating linkage. Any rubbing against cover requires re-alignment of disc follower frame and selector levers.

9. Look for tightness of needle vibrating fork, #188417 between arm and link. There should be .005" to .008" end-play.

10. If noise seems to occur only when sewing, check take-up lever linkage for up and down play. If loose, replace take-up lever.



"THUMPING" NOISE

This type of noise occurs when crossing heavy, welted seams or when crossing lines of satin stitching as would be done in many forms of monogramming.

Test needle bar linkage for up-and-down play. Excessive play in the needle bar connecting link assembly is the cause. A loose fitting throat plate will also cause a similar noise. Test throat plate by tapping at curved end with a rigid finger, as shown in **Fig. 258B**.

To replace the connecting link #105015 (C, **Fig. 258**):

(a) Raise needle bar to its highest position.

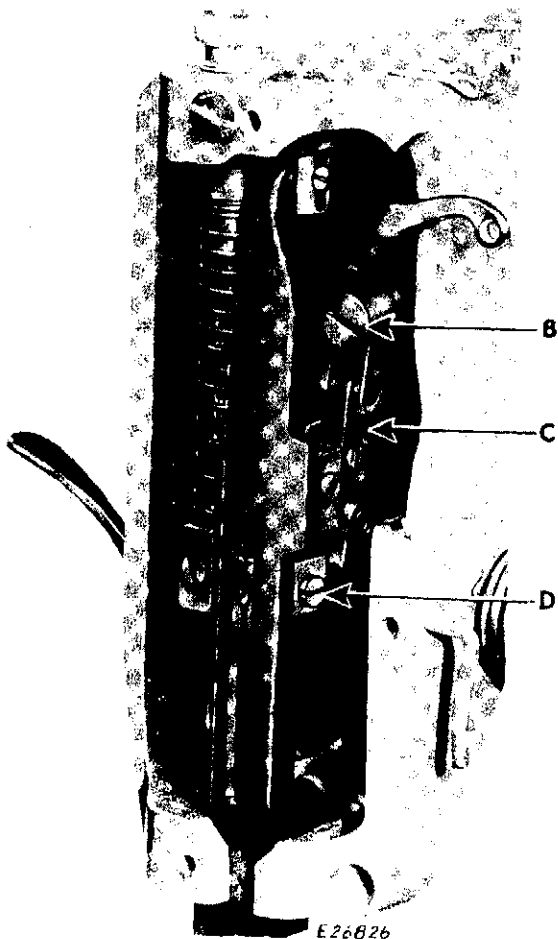

Fig. 258. To Replace Needle Bar Connecting Link

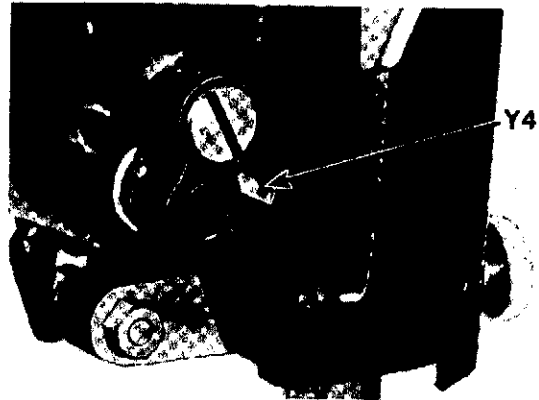

Fig. 258A. To Replace Needle Bar Connecting Link

- (b) Loosen pinch screw **Y4**, **Fig. 258A** and disconnect fork.
- (c) Remove needle, needle clamp and throat plate.
- (d) Loosen needle bar screw **D**, **Fig. 258** and pull needle bar down through throat plate opening.
- (e) Loosen screw **B**, **Fig. 258** which holds thread take-up crank and ease out complete assembly.

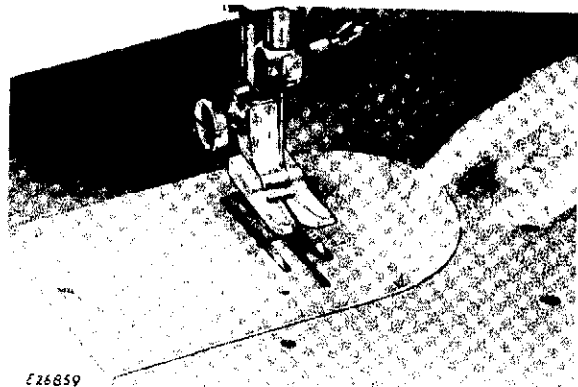

Fig. 258B. Testing Throat Plate for Looseness

TO OIL THE MACHINE

Occasionally apply a drop of oil to all points indicated by unlettered arrows in **Figs. 259 to 264.**

Apply a small amount of oil to slide block **W6,** **Fig. 260.**

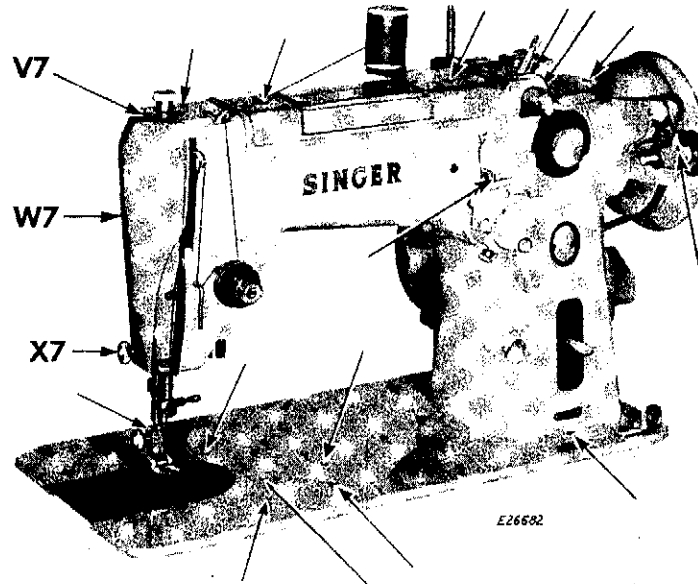

Fig. 259. Front View—Showing Oiling Points

Carefully clean the machine to insure smooth and satisfactory performance.

CAUTION: DO NOT LUBRICATE the arm shaft

When the arm shaft connection belt becomes loose or worn, it should be removed and replaced as instructed on **pages 106 and 107.**

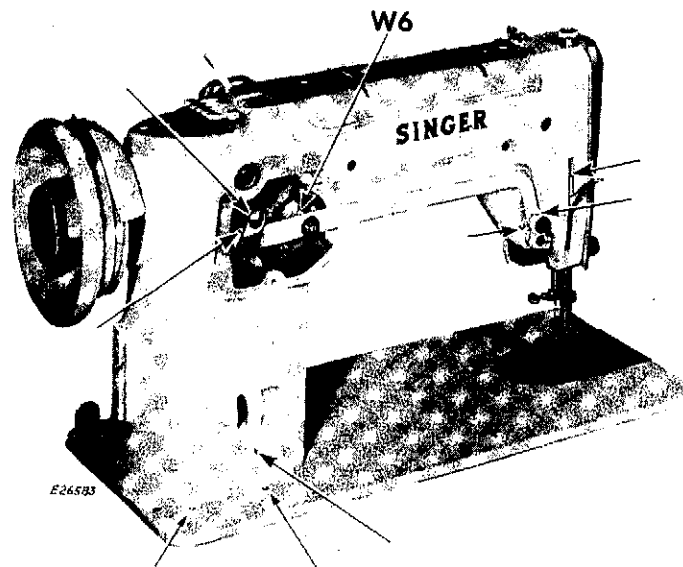

Fig. 260. Rear View—Showing Oiling Points

connection belt. To ensure the long life and efficient performance of the belt, it must be kept clean and free from excess oil at all times.

NOTE: Motor and **SINGER light** have been removed for clearer view of parts but need not be removed when actually oiling machine.

Remove face plate **W7**, **Fig. 259** by taking out thumb screw **X7**, and slipping plate up and off screw at **V7**.

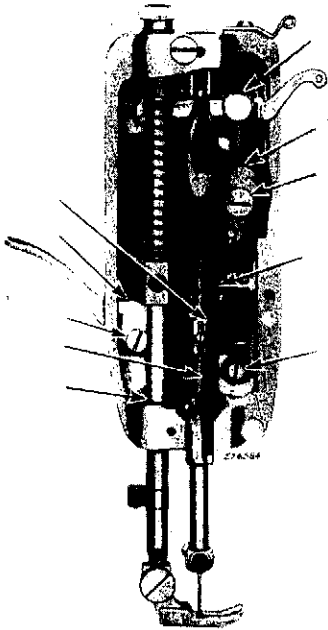

Fig. 261. Face Plate Removed Showing Oiling Points

Oil the points indicated by unlettered arrows in **Fig. 261**. Replace the face plate.

TO GREASE GEARS

CAUTION: The grease, packed in the hook shaft gear case under the bed of the machine as shown in **Fig. 262**, does not require changing unless this section of the machine has been submerged in cleaning fluid. When necessary, remove the two screws at **E4**, **Fig. 262** and the gear case cover **D4** from gear case. Then repack the gear case with **SINGER GEAR LUBRICANT**.

This lubricant, No. 121915, is obtainable in 4 oz. tubes on order from the factory. **DO NOT USE MOTOR LUBRICANT**, white lubricant S-6 or any other lubricant except **SINGER GEAR LUBRICANT** for this purpose.

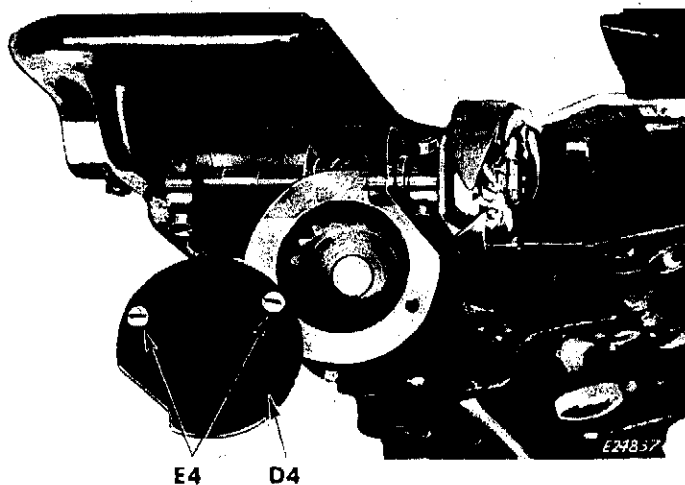

Fig. 262. To Grease Hook Shaft Gear Case

Occasionally apply a drop of oil to the race of the bobbin case holder as shown by unlettered arrow in **Fig. 263**.

Turn the machine back on its hinges and oil the places shown by unlettered arrows in **Fig. 264**.

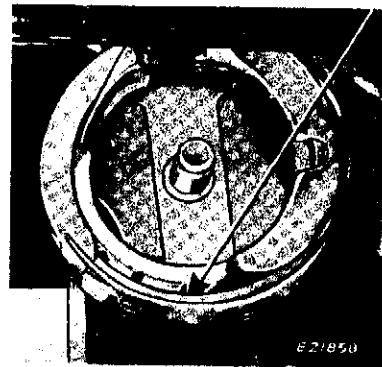

Fig. 263. Oiling Point in Bobbin Case Holder

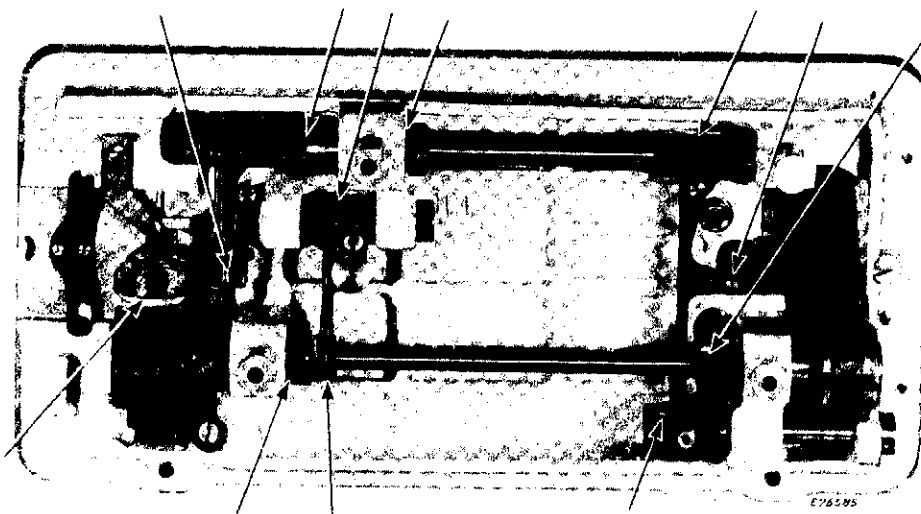

Fig. 264. Oiling Points in Base of Machine

CAUTION: DO NOT LUBRICATE arm shaft connection belt. See instructions on **pages 106** and **107** for replacing a loose or worn belt.

DANGERS OF OVER-LUBRICATION

The application of too much oil to the sewing machine parts can cause damage to the arm shaft connection belt, as explained on **page 121**, or can cause damage to fabrics and threads used during sewing.

One or two small drops of oil at the right point, when needed, will give the machine the protection it requires. Excess oil is merely a waste, as well as a source of danger to the appearance of the work accomplished on the machine.

)

)

)

SINGER AUTOMATIC SWING-NEEDLE MACHINES OF CLASS 401

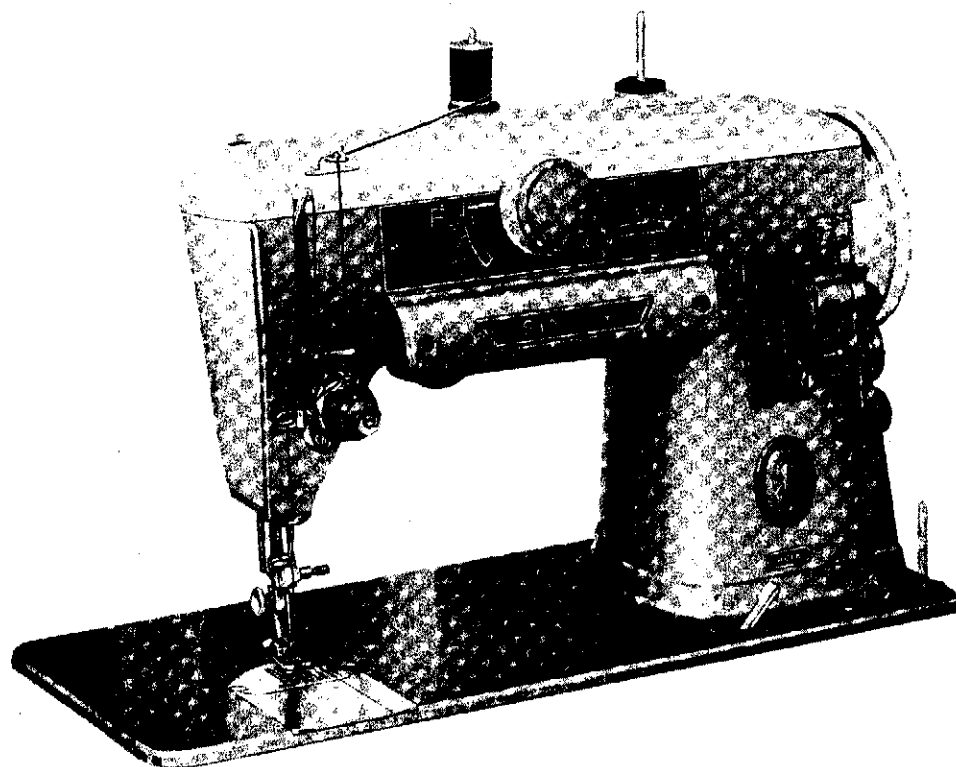

Fig. 265. Machine 401A

The instructions on **pages 1 to 79** generally apply to Class 401 Automatic Swing-Needle Machines.

Specific instructions which apply only to Machines of Class 401 appear on **pages 125 to 162**.

For detailed information concerning OPERATION of Machines of Class 401, see regular instruction book, **Form 20857**.

PREPARATION OF MACHINE FOR INSPECTION

Before any extensive inspection is undertaken to find causes of faulty operation, machine should be thoroughly cleaned and oiled.

Remove all lint, dust or other foreign particles from machine.

Remove motor, light and wiring harness, as described on **pages 145 to 147** and dip machine in large container of Varsol. If grease or dirt has become considerably hard and tacky it may be neces-

sary to leave machine in Varsol for several hours.

Wipe machine clean and dry.

Oil the machine as instructed below and on **page 127**.

Wipe away all surplus oil.

See **pages 4 to 7** for general tips on setting up and inspection.

LUBRICATION

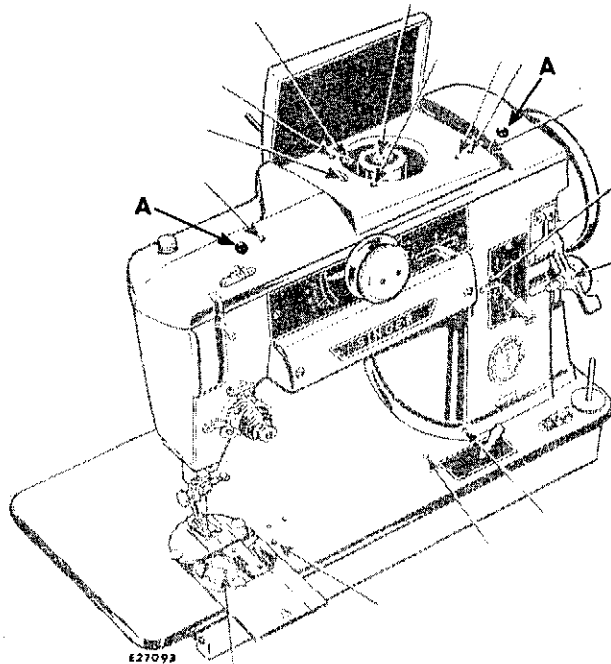

Fig. 266. Front View — Oiling

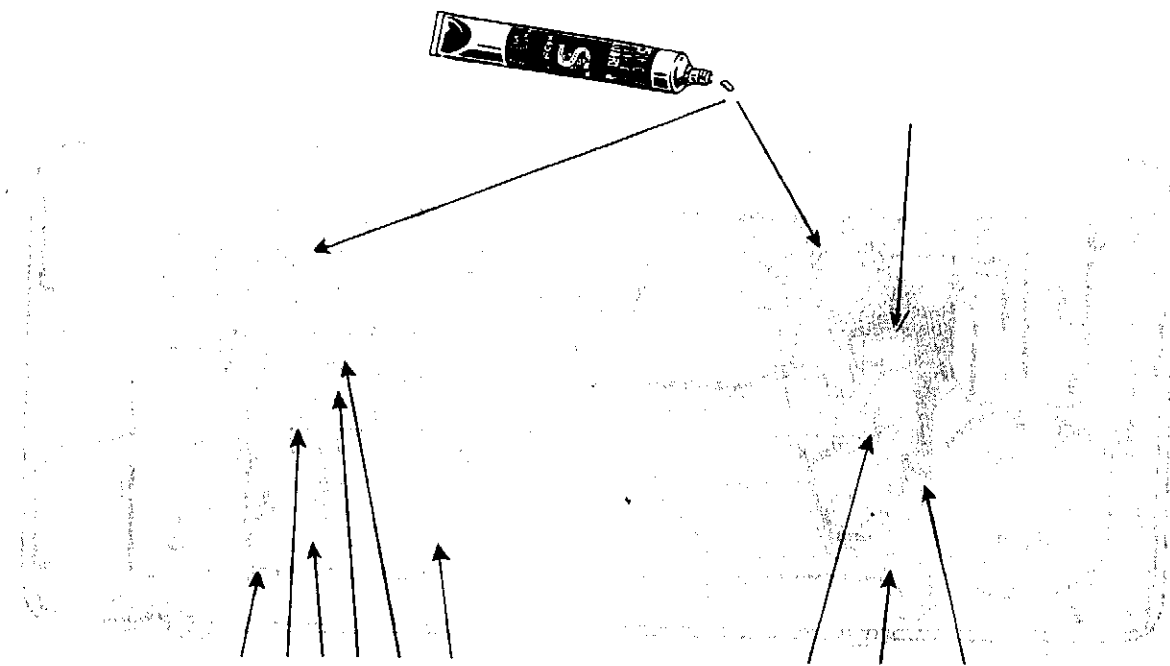

Fig. 267. Bottom View — Oiling

Open the face plate to oil the places indicated in **Fig. 268**. Tilt machine back on its hinges. Set the controls at A-K-5 for access to take-up linkage.

Keep all gears well lubricated with SINGER GEAR LUBRICANT.

Fig. 267 shows the two sets of gears beneath the machine bed.

Fig. 269 shows the other two sets of gears at top of arm. To reach these gears, loosen the two screws **A**, **Fig. 266** and remove arm top cover.

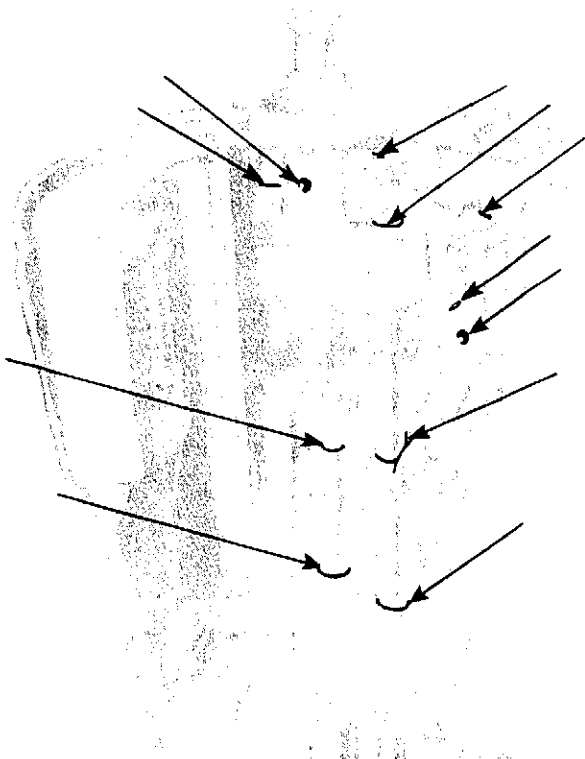

Fig. 268. End View — Oiling

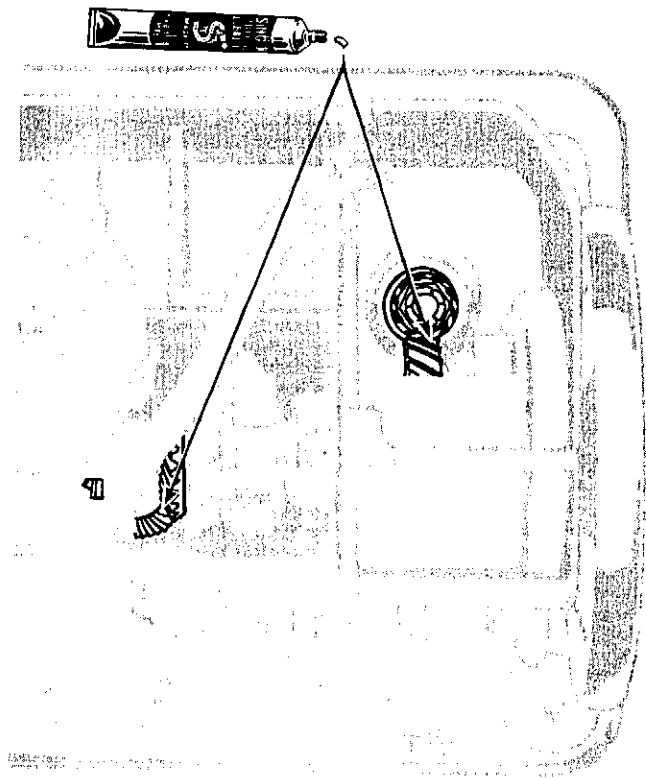

Fig. 269. Gears at Top of Arm

TO SET PRESSER FOOT AT CORRECT HEIGHT

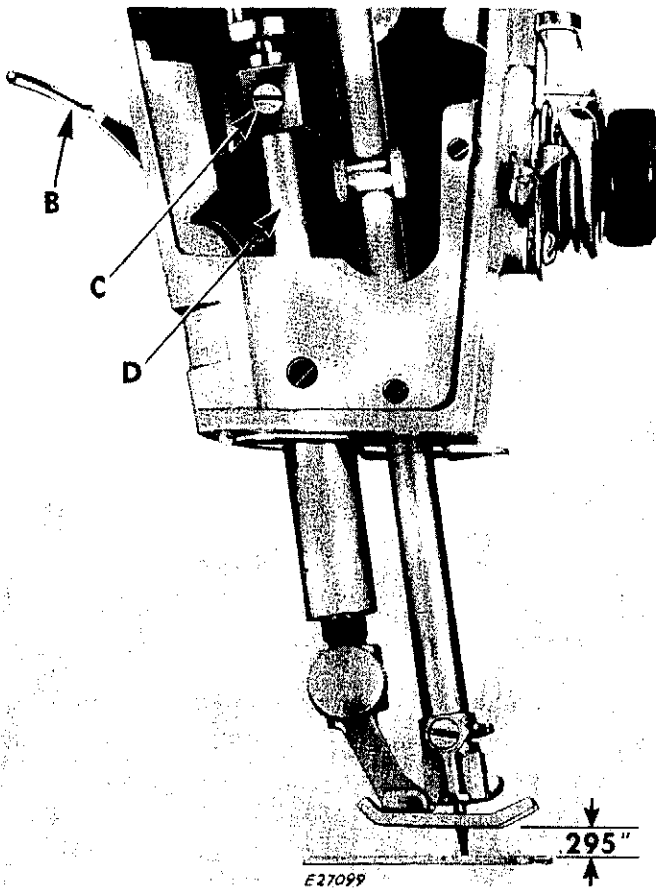

Fig. 270. Setting Presser Foot at Correct Height

IMPORTANT: Unless presser foot is set at correct height, attachments for this machine may not fit correctly on presser bar.

CAUTION: Throat plate must be **down**, flush with bed slide, while setting presser foot height.

CHECK:

Raise presser bar lifter **B**, Fig. 270, raising presser foot to highest position.

Bottom of presser foot should be .295 inch above top of throat plate.

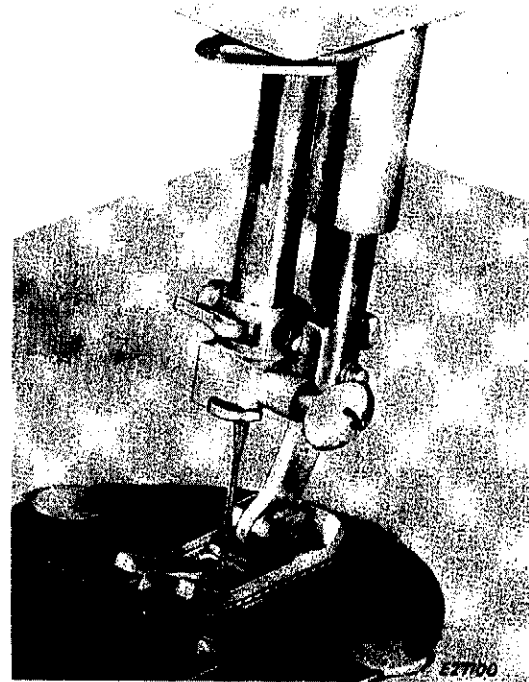

Fig. 271. Presser Foot in Alignment with Slots in Throat Plate and with Feed Dog

Test alignment of presser foot to slots in throat plate and to feed. Fig. 271 shows presser foot in correct alignment. (See instructions on page 57.) Height of presser foot and alignment with slots in throat plate must be set at same time.

NOTE: On Machines of Class 401, the first four pairs of teeth are **not** lower than the rear teeth but are level with them, as shown in Fig. 274. Therefore, tissue paper cannot pass beyond front teeth when feed dog and presser foot are in proper alignment.

SETTING:

Loosen set screw **C**, Fig. 270. Raise or lower presser bar **D** as required.

Align presser foot and securely tighten screw **C**.

TO SET FEED DOG AT CORRECT HEIGHT

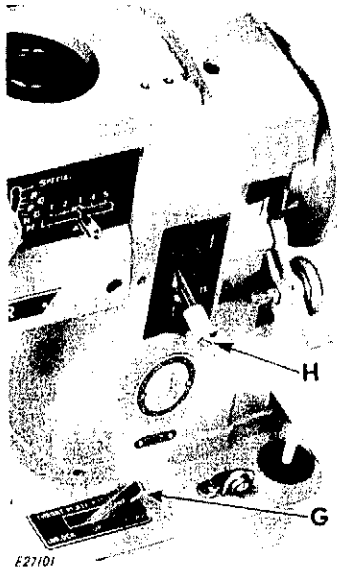

Fig. 272. Machine Set for Sewing at 12 Stitches per Inch

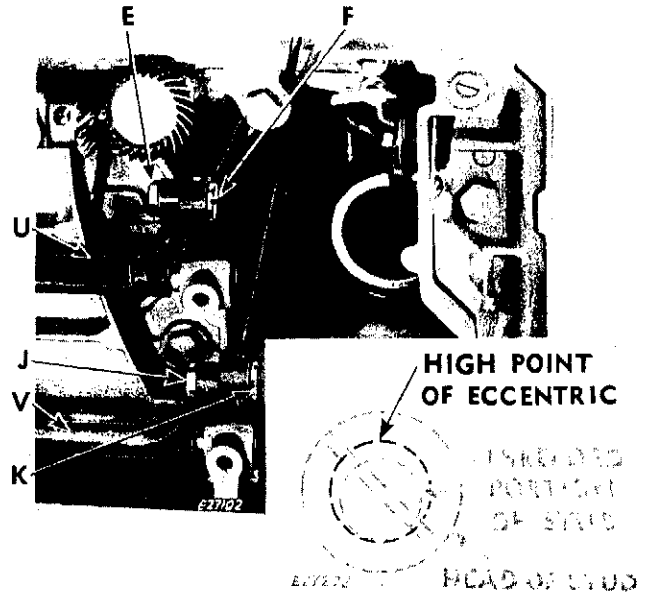

Fig. 273. Feed Adjustments

PREPARATION :

Remove bottom cover, motor hold-down plate and motor, as instructed on **page 145**.

Set throat plate position lever **G**, **Fig. 272** at "DOWN" position for sewing and set machine for forward stitching at approximately 12 to 15 stitches per inch as shown at **H** in **Fig. 272**.

Turn machine pulley over toward operator until feed dog is at its highest position.

CHECK:

With feed dog at highest position, feed dog teeth should project .040 to .043 inch above top surface of throat plate, as shown in **Fig. 274**. Use Gauge No. G34202 for setting correct feed dog height as shown in **Fig. 38A**, **page 30**.

SETTING:

Loosen nut **E**, **Fig. 273** and turn eccentric stud **F** until high point of eccentric is toward rear of machine bed, as shown in **Fig. 273** (inset), making the distance between stud **F** and feed lifting rock shaft **U** as short as possible. Then turn eccentric stud **F**, as required to bring feed dog to correct height. Maintain this setting while tightening nut **E** securely.

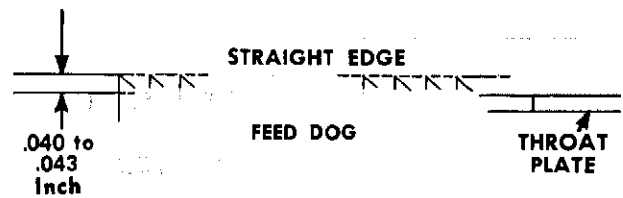

Fig. 274. Feed Dog at Correct Height

TO SET FEED DOG LENGTHWISE IN THROAT PLATE SLOTS

PREPARATION :

Set feed dog at correct height as instructed above.

Set throat plate position lever **G** and stitch regulator **H**, as shown in **Fig. 272**.

CHECK:

Feed dog should be as close as possible to needle slot in throat plate without striking, to insure efficient performance of stitching mechanism.

SETTING:

Loosen nut **J**, **Fig. 273**.

Turn eccentric stud **K** until high point of eccentric is toward rear of machine bed, as shown in **Fig. 273** (inset), making distance between stud **K** and feed rock shaft **V** as short as possible. Then turn eccentric stud **K**, moving feed dog toward front or rear as required. Securely tighten nut **J**.

**TO SET FEED DOG SIDEWISE IN THROAT PLATE SLOTS
AND TO ELIMINATE NOISE IN FEED MOVEMENT**

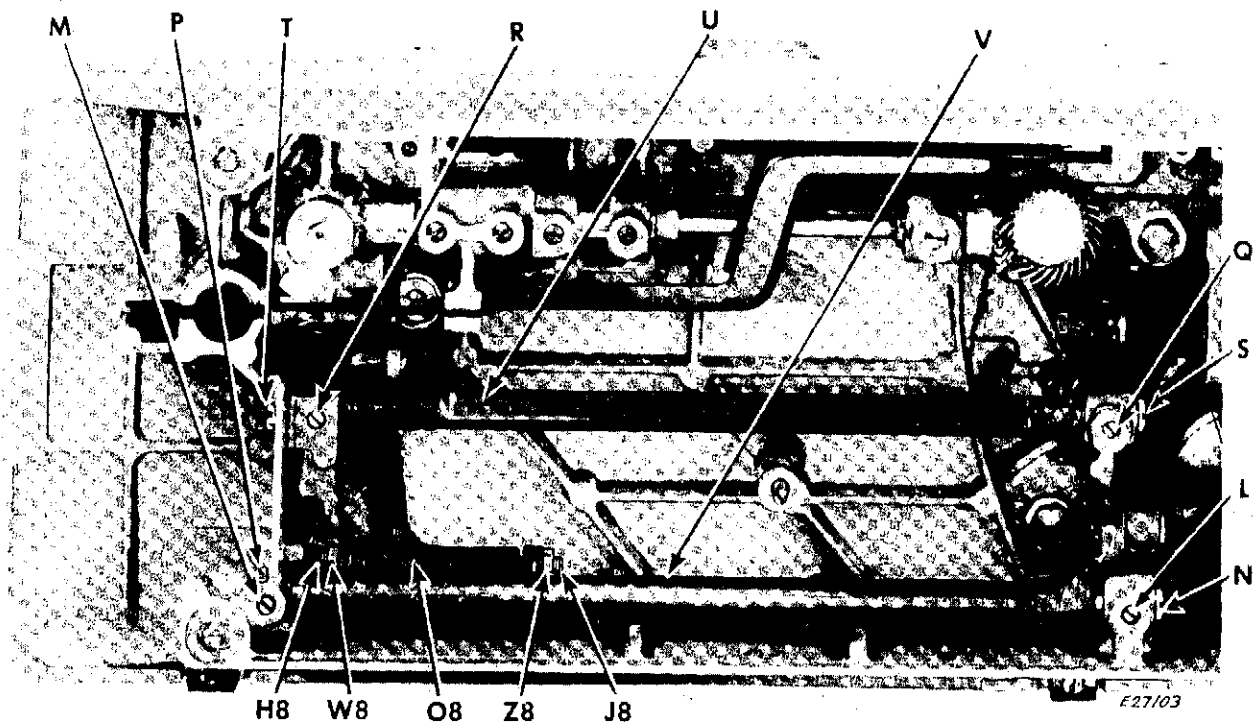

Fig. 275. Setting Feed Sidewise

PREPARATION :

Set the feed dog at the correct height as instructed on page 129.

CHECK:

The feed dog should be located centrally (along the bed) in the feed dog slots of the throat plate.

SETTING:

Loosen set screws **L** and **M**, **Fig. 275** that hold screw centers **N** and **P** and feed rock shaft **V** in position.

Loosen set screws **Q** and **R**, **Fig. 275** that hold screw centers **S** and **T** and feed lifting rock shaft **U** in position.

Loosen screw centers **S** and **T** slightly to permit movement of feed dog toward left or right.

To position feed dog toward left, loosen screw center **P** and tighten screw center **N** an equal amount, as required.

To position feed dog toward right, loosen screw center **N** and tighten screw center **P** an equal amount, as required.

When feed dog is centralized in throat plate, make certain screw centers **N** and **P** hold feed rock shaft snugly (without end play or binding). Then securely tighten set screws **L** and **M**, **Fig. 275**.

Tighten screw centers **S** and **T** equally upon feed lifting rock shaft **U** so that shaft **U** rides freely without end play or binding. Then securely tighten set screws **Q** and **R**, **Fig. 275**.

NOTE: Check for end play or binding in feed bar **O8**, **Fig. 275**. To adjust, loosen nuts **W8** and **Z8** and turn screw centers **J8** and **H8**, as required. Re-check sidewise position of feed dog, and adjust if necessary, as instructed above. Tighten nuts **W8** and **Z8**.

TO ADJUST THREAD CLEARANCE

PREPARATION :

Remove needle, throat plate and bed slide.

CHECK:

Using narrow feeler gauge, Serial No. 187928, check these thread clearances —

At **A2**, Fig. 280, between bobbin case cushion spring and heel of bobbin case, there should be a clearance of .012 to .014 inch.

At **B2** on other side of spring, between spring and bracket — clearance should be .012 to .014 inch.

At **C2**, between hook race and underside of spring — clearance should be .016 to .018 inch.

Clearance between rear corner of bobbin case and top of spring, shown at **D2**, Fig. 276 should be approximately $\frac{3}{64}$ inch. This distance can be checked with a simple scale rule.

Check for wear and need for replacement of cushion spring and of screws **E2** and **F2**, Fig. 276.

SETTING:

To adjust clearances at **B2**, **C2** and **D2**, Fig. 276, loosen screws **E2** and **F2** and move cushion spring as required.

NOTE: Hole in spring for screw **E2** is elongated and hole for screw **F2** is oversize to facilitate adjustment.

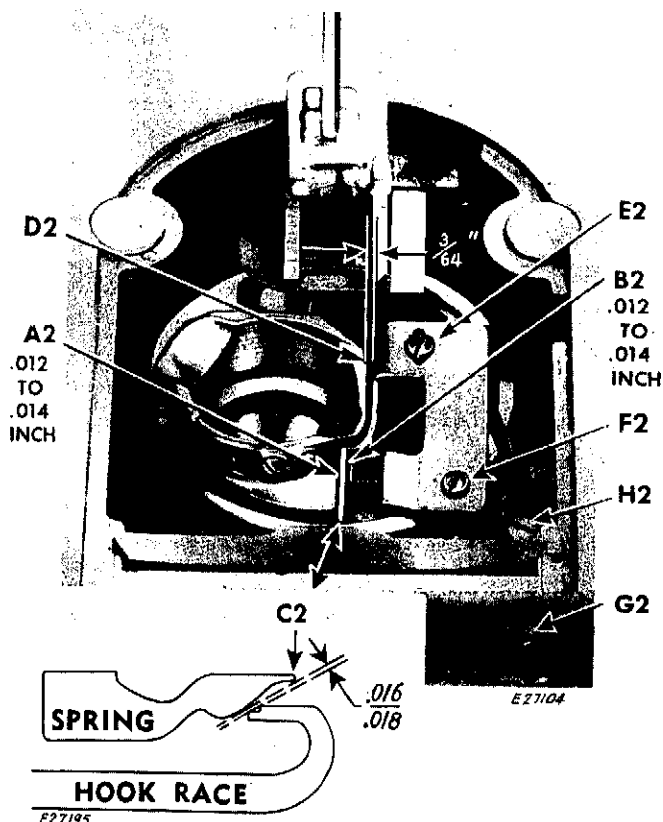

Fig. 276. Thread Clearances

Move spring toward rear to increase clearance **C2** or toward front to decrease clearance **C2**.

To adjust thread clearance at **A2** (.012 to .014 inch), loosen set screw **G2** and turn eccentric stud **H2** as required to move spring and bracket toward or away from bobbin case heel. Securely tighten screw **G2**.

When all three clearances have been obtained, at same position of spring, securely tighten screws **E2** and **F2**.

FEED TIMING

CAUTION: Feed eccentric is correctly set at the factory.

This timing should not be altered.

TO SET THE CHECK SPRING

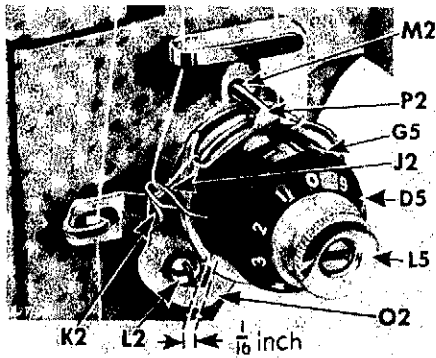

Fig. 277. Setting the Stroke

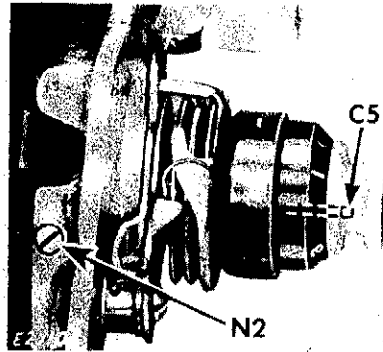

Fig. 278. Stud Set Screw

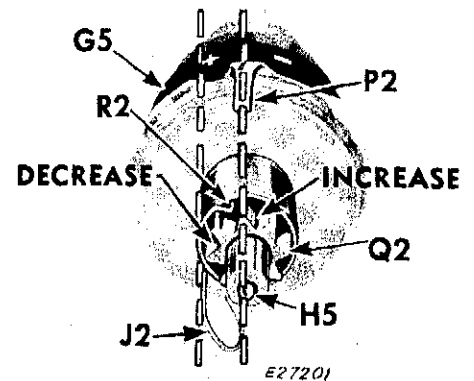

Fig. 279. Setting Tension

SETTING THE STROKE:

Loosen screw **L2** and move regulator **O2** until right end of slot in regulator is $1/16$ to $3/32$ inch to right of head of screw **L2**, as shown in **Fig. 277**. Move regulator up toward left for shorter stroke or down toward right for longer stroke. Tighten screw **L2**.

SETTING THE TENSION:

Loosen stud set screw **N2**, **Fig. 278** and remove entire assembly, as shown in **Fig. 279**.

Hold tension assembly so that component parts are in position shown in **Fig. 279**.

Place end **R2** of spring **J2** in groove of sprocket **Q2** so that spring will hang down as shown; with line of spring **J2** parallel to a line that bisects the dividing line between the plus (+) and minus (-) lines on indicator **G5**, the extension **P2** and the pin **H5**, as shown in **Fig. 279**. Increase or decrease tension by moving end **R2** of spring **J2** to some other groove in direction shown by arrows in **Fig. 279**. Replace assembly. Draw spring **J2** to rest on stop **K2**, **Fig. 277** and recheck tension. Tighten set screw **N2**, **Fig. 278**.

TO ADJUST NEEDLE THREAD TENSION

Use #50 mercerized thread.

Lower the presser bar.

Check for a **slight perceptible tension** on needle thread.

When tension is incorrect, turn thumb nut **L5**, together with the numbered dial **D5**, over toward the left until the "0" is at the top, as shown in **Fig. 277**.

Now insert pin **C5** in various holes of the dial **D5** until one is found which gives a **slight perceptible tension** when the thumb nut **L5** is turned to the extreme left and the numeral "0" is on top of the dial, as shown in **Fig. 277**.

NOTE: There should be no tension when dial **D5** is turned over toward left to a point between "0" and "9".

This tension gradually **increases** with the turning

of the thumb nut **L5** over toward the right; providing the full range of tensions required from light to heavy (with but one revolution of the thumb nut **L5**).

TO SET NEEDLE BAR AT CORRECT HEIGHT

PREPARATION:

Set red lever at #3 position and stitch selector knobs at **A** and **K**, as shown in Fig. 295, page 142.

Insert two needles (same size) up into needle bar.

CHECK:

Turn hand wheel over toward operator until needle bar is at its lowest point. At this position the **UPPER** timing mark on the needle bar should be level with lower end of needle bar ball bushing **Z**, as shown in Fig. 280.

Then turn hand wheel until hook point is behind needles. If needle bar is correctly turned, both needles will be an equal distance in front of the point of the hook.

SETTING:

Turn hand wheel over toward operator until needle bar is at lowest point.

Loosen screw **W**, Fig. 280.

Raise or lower needle bar, as required.

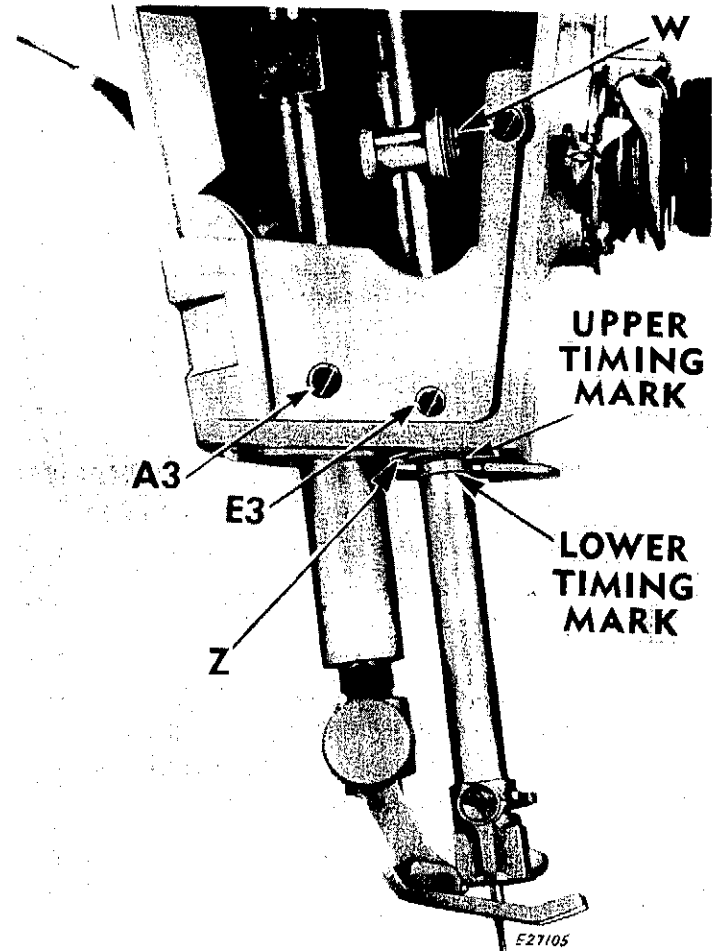

Fig. 280. Timing Marks on Needle Bar

While maintaining needle bar at correct height, make certain needle bar is correctly turned, then tighten screw **W**.

TO CHECK THE POSITION OF THE NEEDLE IN RELATION TO STRAIGHT-STITCHING THROAT PLATE

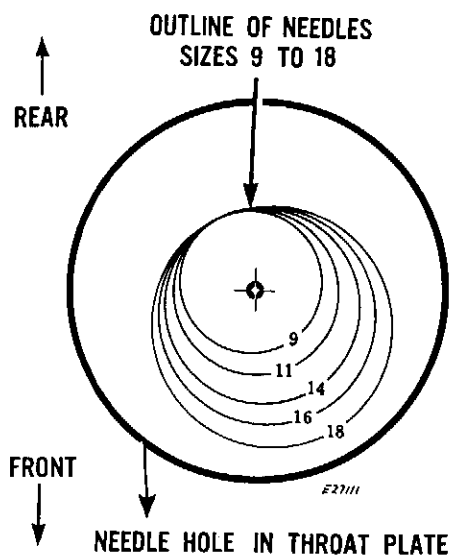

Fig. 281. Needle Hole in Straight-Stitching Throat Plate

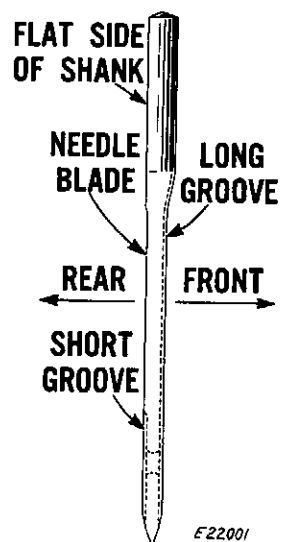

Fig. 282. 15 x 1 Needle

PREPARATION:

Set red lever at **#3 position** and selector knobs at **A** and **K**, for straight-stitching at central position, as shown in **Fig. 295, page 142**.

Install straight-stitching throat plate.

CHECK:

When the needle enters the needle hole in **straight-stitching throat plate**, the short-groove (flat shank) side of the needle should face slightly to the left of rear, as shown in **Fig. 281**.

Although the size of the needle may be changed to suit sewing requirements, the position of the **flat shank side of the needle remains CONSTANT in relation to the needle hole** in the throat plate.

Observe that the center of a Size #11 needle should be at the approximate center of the needle hole in the throat plate and that the center of each larger size needle advances toward the **front** of the needle hole.

This position is necessary to permit an increase in the diameter of the needle blade toward the front without disturbing the proper relationship between the needle and the sewing hook. This position of the

needle will also maintain sufficient clearance for the needle thread.

At no time should the needle touch the edge of the needle hole. The needle should never strike the presser foot.

If the needle is incorrectly located in the throat plate hole: —

Needle bar setting may be incorrect from front to back or from right to left (see **page 142**).

Needle bar shakes in ball bushings (see **page 142**).

Needle or needle bar may be bent. (Replace.)

Needle seat in needle bar may be clogged with dirt or be damaged (see **page 126**).

Throat plate may be incorrectly seated (see **page 152**).

If the needle strikes the presser foot, any of the above conditions may be at fault, or:

Presser bar may be bent, damaged or turned out of position (see **page 128**).

Presser foot may be incorrectly seated on the presser bar.

Presser foot may be bent. (Replace.)

TO ELIMINATE SIDE-SHAKE OR BINDING OF NEEDLE BAR

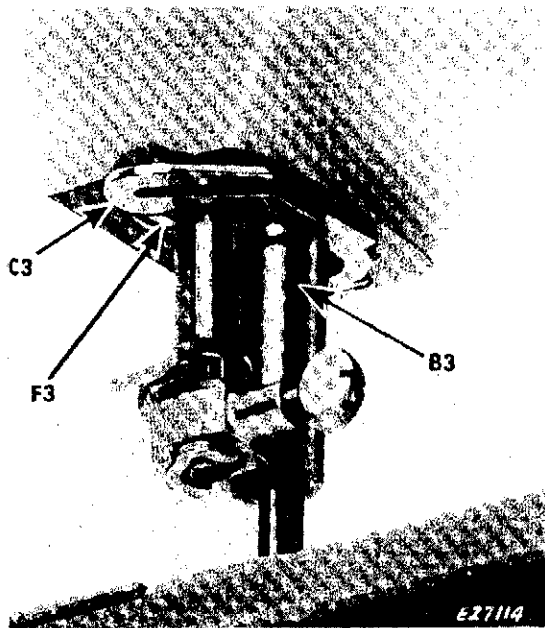

Fig. 283. Lower Needle Thread Guide

End play or binding of needle bar is usually the result of an incorrectly adjusted ball bushing at **F3**, **Fig. 283** or **H3**, **Fig. 283A**.

To adjust lower ball bushing, first remove presser foot. Loosen screw **A3**, **Fig. 280**, page 133 and lower presser bar bushing **B3**, **Fig. 283** and guide **C3**, **Fig. 283**.

Loosen set screw **E3**, **Fig. 280**.

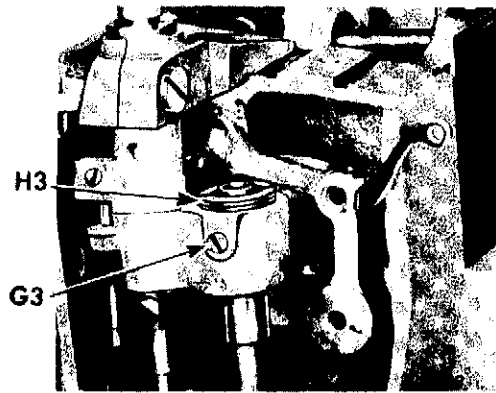

Fig. 283A. Upper Ball Bushing

Loosen or tighten adjusting screw at **F3**, **Fig. 283**, as required. (Use a 1/2 inch spanner wrench.)

Upper ball bushing may be adjusted with a 1/2 inch spanner wrench at **H3** after loosening set screw **G3**, **Fig. 283A**.

CAUTION: Tightening the set screws **E3** and **G3** may tend to make the ball bushing bind slightly. Adjust accordingly, setting ball bushings individually. Then tighten set screws **E3** and **G3**.

Replace needle thread eyelet **C3** on groove in presser bar bushing **B3**, as shown in **Fig. 283**.

Replace presser bar bushing **B3** with needle thread eyelet, as shown in **Fig. 283**.

Tighten set screw **A3**, **Fig. 280**.

CHECK THESE POINTS WHEN STITCH REGULATOR STICKS, CREEPS OR BINDS

1. Looseness of screws.
2. Dirt on, or damage to moving parts.
3. Feed rock shaft centers too loose or too tight.
4. Bent stitch regulator handle.
5. Too much friction in friction fork on stitch regulator.
6. Bent feed regulator connection rod.
7. Worn or jammed slide block in feed forked connection.
8. Worn or damaged feed rock shaft.
9. Binding in feed lifting rock shaft connecting rod.
10. Too much pressure on presser bar when sewing heavy material.

TO ELIMINATE END PLAY OR BINDING OF FEED ROCK SHAFT AND FEED LIFTING ROCK SHAFT

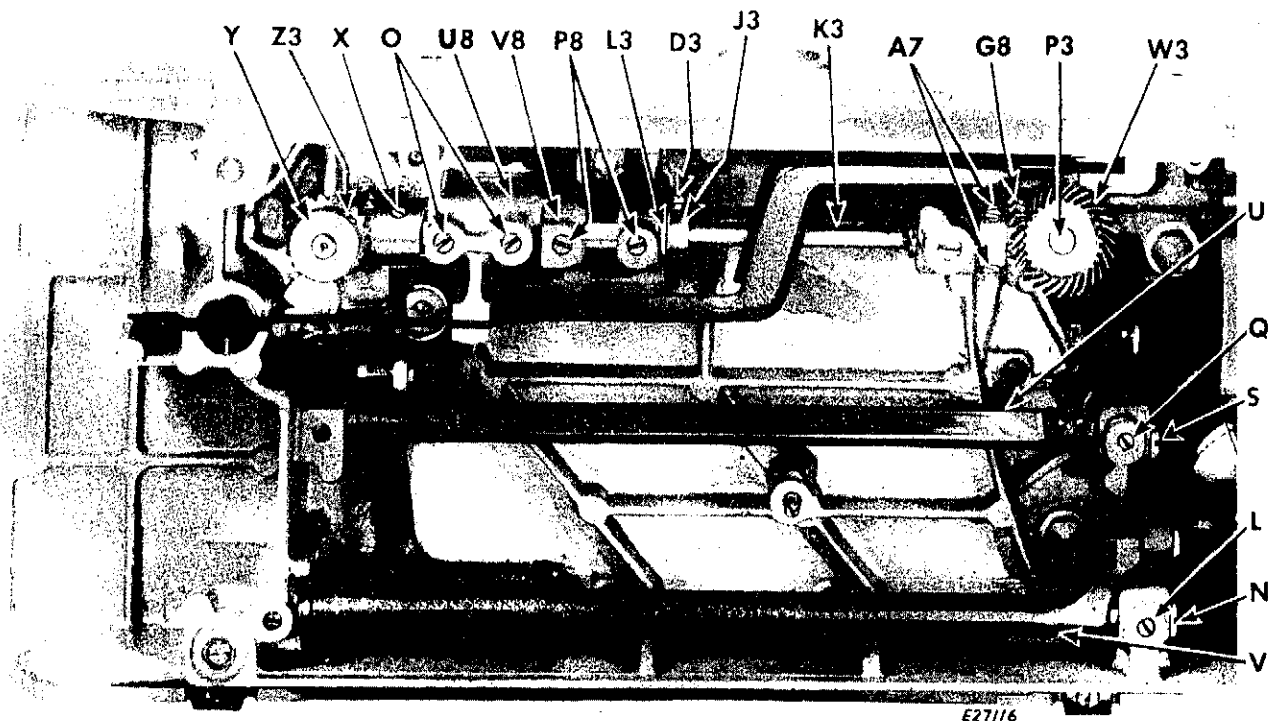

Fig. 284. Elimination of End Play or Binding
beneath Machine Bed

To eliminate end play or binding of feed rock shaft **V**, Fig. 284, loosen set screw **L** at right end of shaft and adjust screw center **N**, so that shaft rides snugly but freely, (without any left or right movement).

Securely tighten set screw **L**.

To eliminate end play or binding of feed lifting rock shaft **U**, Fig. 284, loosen set screw **Q** at right end of shaft and adjust screw center **S**, as required.

Securely tighten set screw **Q**.

Check and adjust feed bar for end play or binding, as instructed on page 130.

TO ELIMINATE END PLAY OR BINDING OF HOOK DRIVING SHAFT

To eliminate end play or binding of hook driving shaft **K3**, loosen two set screws **O** and two set screws **P8**, Fig. 284. Then loosen set screw **D3** in collar **J3**, Fig. 284 and two set screws **A7** in bevel gear **G8** at right end of shaft.

Check for end play on rotating hook shaft. To adjust, loosen set screw **Z3**. Press gear **Y** up against its bearing and retighten screw **Z3**.

NOTE: KEEP ALL GEARS IN MESH. (See **CAUTION** at top of page 154.)

Hold hook bracket **U8** against lug **V8** and push bushing **L3** toward left against bevel gear at left end of shaft **K3** so that there will be no looseness nor binding. Securely tighten two set screws **P8** and two set screws **O**, Fig. 284. Press collar **J3** firmly against bushing **L3** and tighten set screw **D3**. Adjust gear mesh at right end of shaft **K3** so that there is neither backlash nor binding. While maintaining this adjustment, tighten the two set screws **A7** in gear **G8**.

Check timing of hook, as instructed on page 143.

Adjust position of hook in relation to needle as instructed on page 144.

TO ELIMINATE END PLAY OR BINDING OF UPRIGHT ARM SHAFT

To eliminate end play or binding of upright arm shaft **P3**, Fig. 284, page 136, loosen set screw in lower bevel gear **W3**.

See **CAUTION** on page 154.

While pressing downward upon shaft **P3** from top

of machine, set gear **W3** firmly against bearing on casting and tighten its set screw.

Adjust hook driving shaft for end play or binding, as instructed on page 136.

Adjust horizontal arm shaft for end play or binding, as instructed below.

TO ELIMINATE END PLAY OR BINDING OF HORIZONTAL ARM SHAFT

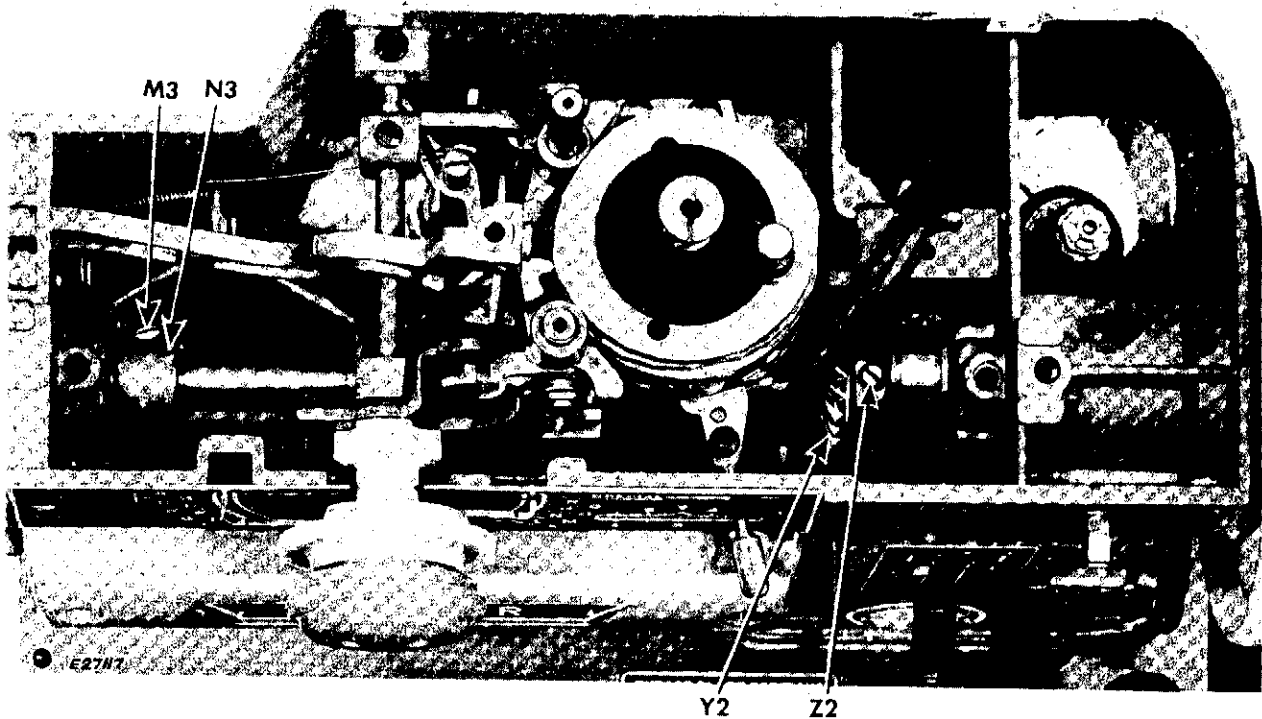

Fig. 285. Adjustments for End Play or Binding of Arm Shaft

When horizontal arm shaft binds, first check to make certain that mesh between the arm shaft worm and the cam stack worm wheel is not too tight. Do this by removing cam stack as instructed on page 158. If the binding is thus released, the eccentric shaft **F8**, Fig. 323, page 159 requires adjustment, as instructed on page 159.

If arm shaft still requires adjustment for end play or binding, loosen set screw **M3** in collar **N3**, Fig. 285. Turn hand wheel until set screw **Z2** on eccentric appears in hole in cap of connecting rod as shown in Fig. 285. Loosen screw **Z2**.

While keeping timing screw **Z2** in groove provided for it in arm shaft, push needle bar crank toward hand wheel end of machine and press bevel gear **Y2**,

Fig. 285 firmly in mesh, without backlash or binding, with bevel gear at top of upright arm shaft. (See **CAUTION** at top of page 154.)

Tighten set screw **Z2** and check for free running.

Press collar **N3** firmly against bushing in head of machine and tighten set screw **M3**.

Check timing of hook, as instructed on page 143.

NOTE: If there is considerable play between hand wheel and hand wheel gear, remove and disassemble hand wheel assembly, as instructed on page 150 and check seating of spring **D6**, Fig. 310.

TO SET THE INDEX PINS AT THE CORRECT HEIGHT

(See Fig. 286)

PREPARATION:

Remove arm top cover and special disc.

Remove lamp shade. Unfasten sewing light from arm of machine, as instructed on page 146.

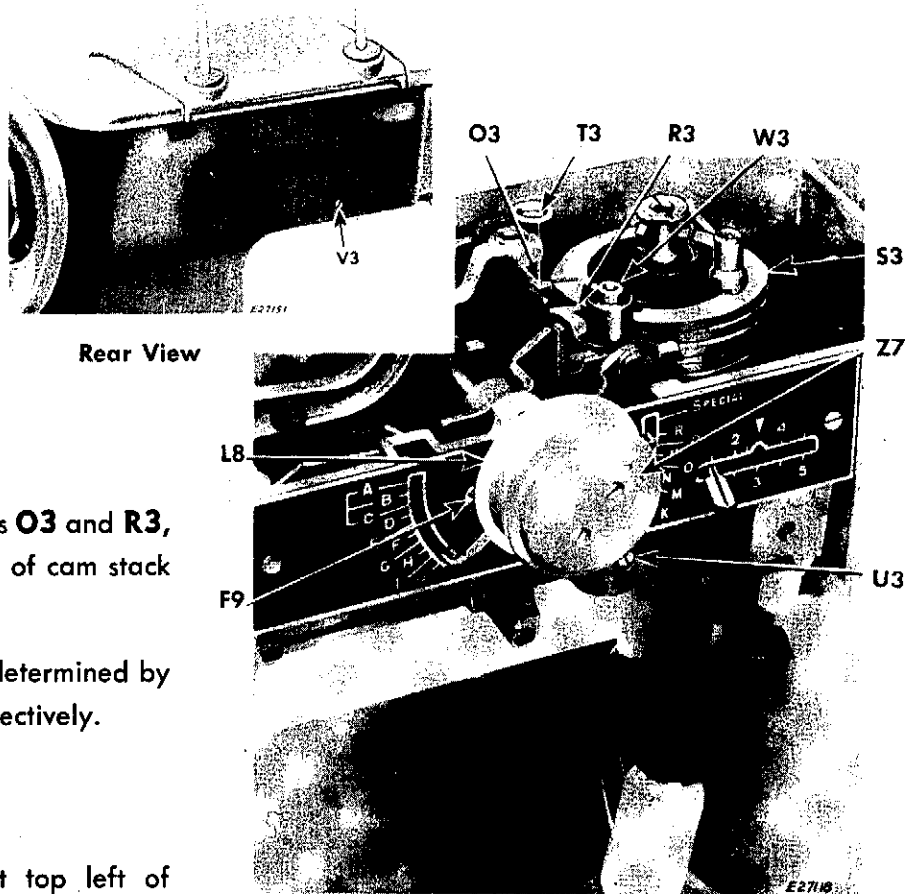

Rear View

CHECK:

Set selector knobs at **J** and **R**, as shown in Fig. 286.

At this setting, top surface of followers **O3** and **R3**, should be 1/64 inch below top surface of cam stack **S3**, as shown in Fig. 286.

Position of followers **O3** and **R3** is determined by height of index pins **T3** and **W3**, respectively.

SETTING:

Loosen set screw **V3** (see inset at top left of Fig. 286) in rear of machine arm.

Raise or lower the rear index pin **T3**, as required. Securely tighten screw **V3**.

Loosen set screw **U3**, on the front of machine arm.

Raise or lower front index pin **W3**, as required.

Securely tighten screw **U3**.

Fig. 286. Setting Index Pins

TO TIME THE CAM STACK

PREPARATION:

Remove arm top cover and special disc.

Using selector knob **Z7**, Fig. 286 bring rear follower **O3** in contact with edge of top cam on cam stack, **S3**, Fig. 287.

Turn hand wheel over toward you until timing mark **X3**, is at point of contact with rear follower **O3**, as shown in Fig. 287.

CHECK:

At this setting, the needle bar should be at its lowest position.

SETTING:

Remove stud and spring **Y3**, Fig. 287.

Turn hand wheel over toward you slowly until needle bar is at its lowest position.

Loosen each of the three clamping screws **Q3**, **Fig. 287** (just one turn).

While holding needle bar at its lowest position, rotate entire cam stack **clockwise**, with the hand, until timing mark **X3** reaches point of contact with rear follower **O3**, as shown in **Fig. 287**.

Tighten the three clamping screws **Q3**.

Replace stud and spring **Y3**. Tighten stud.

Replace special disc and arm top cover.

TO SET CAM SELECTOR ARM STOPS

PREPARATION:

Remove arm top cover.

Check adjustment of worm wheel shaft, as instructed at bottom of **page 159**.

Make certain that screws **F9**, **Fig. 286** and **D8**, **Fig. 287** are securely tightened.

Set selector knobs at **D** and **L**, as shown in **Fig. 322**, **page 158**.

Turn hand wheel over toward front of machine until followers **O3** and **R3**, **Fig. 287**, rest upon high points of bottom (zigzag) cam in cam stack **S3**.

CHECK (Use feeler gauge):

At the above setting, when rear knob **L8**, **Fig. 286** is drawn toward front as far as possible, clearance between front follower **R3**, **Fig. 287** and high point of bottom cam should be .010 to .012 inch.

Also, when front knob **Z7**, **Fig. 286** is pressed toward rear as far as possible, clearance between rear follower **O3**, **Fig. 287** and high point of bottom cam should be .010 to .012 inch.

SETTING:

Loosen set screw **C9**, **Fig. 287**.

Set rear knob **L8** at position **L**.

Move stop **E9**, **Fig. 287** toward front until its front surface contacts rear face of selector arm **M8**, as shown in **Fig. 287**.

Tighten set screw **C9**.

Recheck clearance between front follower **R3** and bottom cam, as instructed.

Loosen set screw **A9**, **Fig. 287**.

Set front knob **Z7** at position **D**.

Press stop bushing **B9**, **Fig. 287** toward the rear until it contacts head of screw **D8**, **Fig. 287**.

Tighten screw **A9**.

Recheck clearance between rear follower **O3** and bottom cam as instructed.

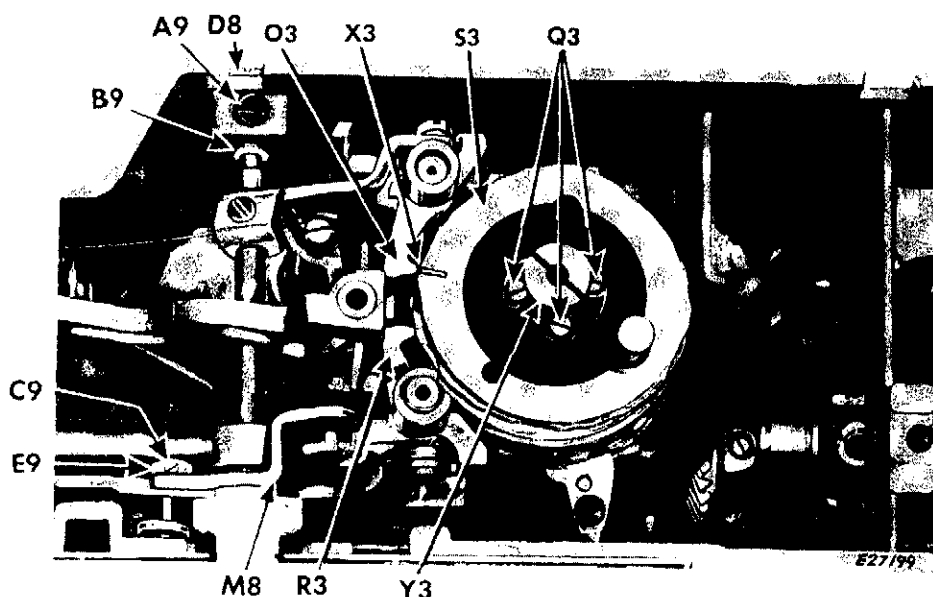

Fig. 287. Timing the Cam Stack

TO ZERO-OUT THE MACHINE

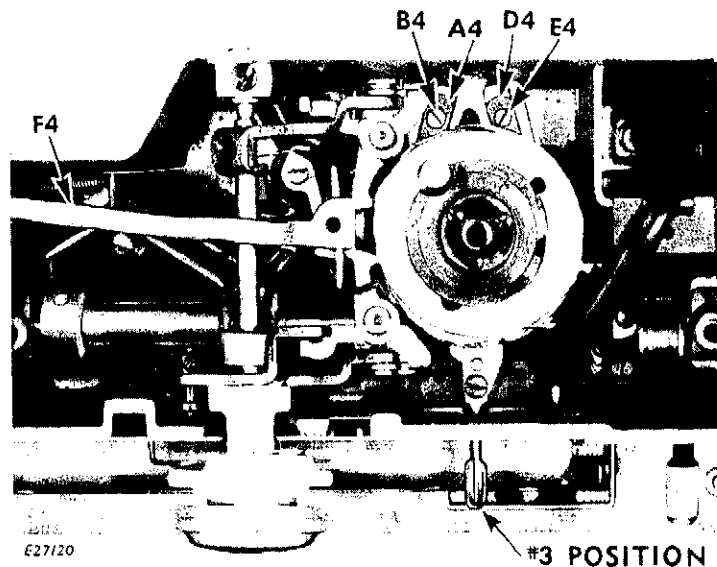
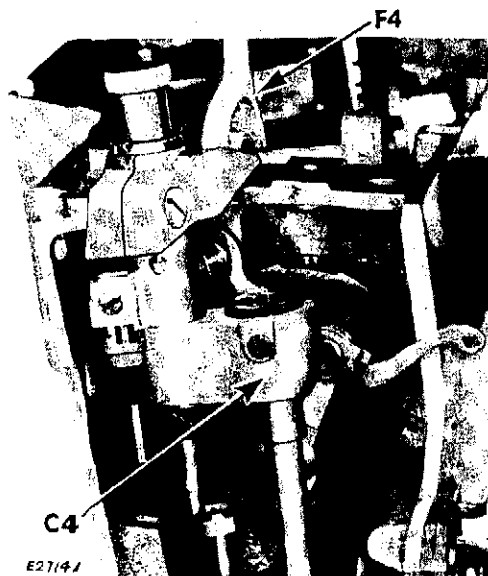

Fig. 288. Setting Bight Amplitude Stop Plates

PREPARATION:

Remove the arm top cover. Set the index pins at correct height, as instructed on **page 138**. Time the cam stack, as instructed on **page 139**.

CHECK (at #1 Position):

When machine is running with selector knobs set at "A" and "L" and red lever set at #3 position, move red lever slowly to #1 position as shown in **Fig. 289**. Movement of the needle bar driving arm **F4**, **Fig. 288** and needle bar vibrating bracket **C4** should stop at same time that movement of red lever stops at #1 position.

SETTING:

Loosen clamping screw **B4**, **Fig. 288**.

Move red lever to #3 position.

Run machine and move red lever slowly toward left to point where there is no movement of needle bar vibrating bracket **C4**. **DO NOT PASS THIS POINT.**

Maintain this position of red lever and move left stop plate **A4** forward against bight amplitude bracket beneath cam stack.

Hold stop plate at this setting and securely tighten screw **B4**.

CHECK (at #5 Position):

When the machine is running with selector knobs set at "D" and "K" and red lever set at #3 position, move red lever slowly to #5 position, as shown in **Fig. 290**. Movement of needle bar driving arm **F4** and needle vibrating bracket **C4**, **Fig. 288**, should stop at same time that movement of red lever stops at #5 position.

SETTING:

Loosen clamping screw **E4**, **Fig. 288**.

Move red lever to #3 position.

Run machine and move red lever slowly toward right to point where there is no movement of bracket **C4** or needle bar driving arm **F4**. **DO NOT PASS THIS POINT.**

Maintain this position of red lever and move right stop plate **D4** forward against bight amplitude bracket beneath cam stack.

Hold stop plate at this setting and securely tighten screw **E4**, **Fig. 288**.



Fig. 289. Setting: A-L-1



Fig. 290. Setting: D-K-5

TO CENTRALIZE THE NEEDLE BAR DRIVING ARM WITH THE DISC SELECTOR ARM BRACKET FOLLOWERS

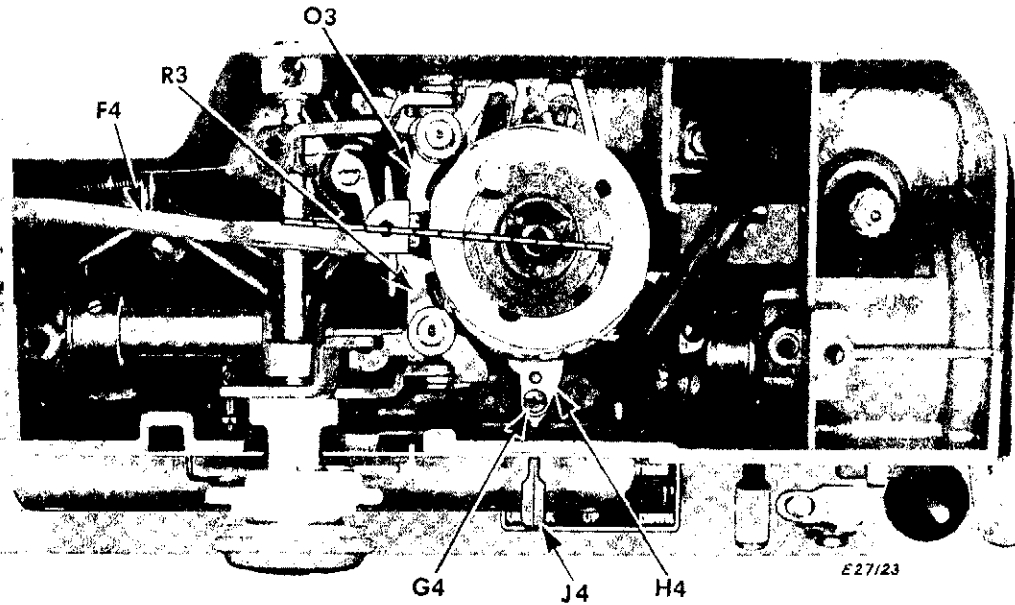

Fig. 291. Centralizing Needle Bar Driving Arm

PREPARATION:

Remove arm top cover.

Zero-out machine correctly, as instructed on page 140.

Set red lever at #3 position, as shown in Fig. 292.

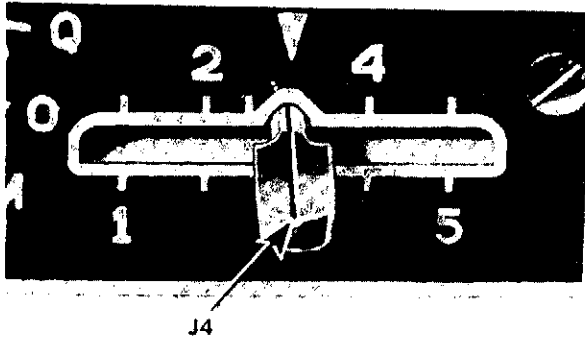

Fig. 292. Red Lever at #3 Position

CHECK:

When the bight amplitude (RED) lever is set at #3 position, the center line of the needle bar driv-

ing arm **F4** should coincide with a point midway between the followers **O3** and **R3**, Fig. 291.

SETTING:

Loosen clamping screw **G4**, Fig. 291.

Push bight amplitude control lever bracket **H4** toward the left as far as possible against the stop **A4**, Fig. 288.

Align center line groove **J4**, Fig. 293 with #1 position, as shown in Fig. 293.

Tighten screw **G4**.

Move red lever as far as possible to the right against the stop **D4**, Fig. 288. Groove **J4** should now be in line with #5 position, as shown in Fig. 294.

If groove **J4**, Fig. 294 is not in line with #5 position, divide the "off" distance in half and, after loosening screw **G4**, position the red lever on bracket **H4** so that it is an equal distance, from the center position #3, at stop positions #1 and #5.

Securely tighten screw **G4**.

Replace arm top cover.

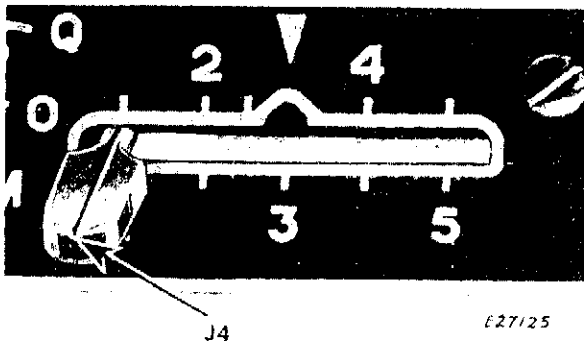

Fig. 293. Red Lever at #1 Position

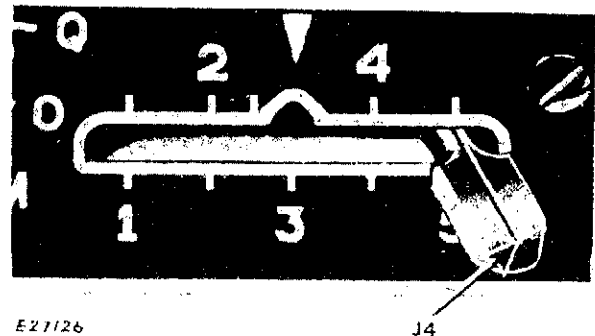

Fig. 294. Red Lever at #5 Position

TO CENTRALIZE THE NEEDLE IN NEEDLE HOLE IN STRAIGHT-STITCHING THROAT PLATE

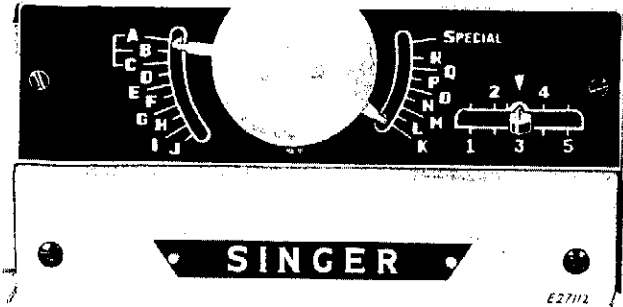

Fig. 295. Setting for Straight
Stitching at Central Position
(A-K-3)

PREPARATION:

Set red lever at position #3 and stitch selector knobs at A and K, as shown in Fig. 295.

Remove arm top cover and face plate.

Install straight-stitching throat plate.

Remove presser foot regulating thumb screw U2, Fig. 296.

Select a Size #11 needle. Check it for straightness and insert in needle bar.

SETTING (Front to Rear Position):

Loosen clamping screw S2 and set screw T2, Fig. 296.

Turn hand wheel until needle is in needle hole in throat plate.

While holding eccentric hinge pin V2, Fig. 296 down against casting and holding vibrating bracket C4, Fig. 296 up against shoulder of eccentric V2, turn eccentric V2 (with spanner wrench) until needle is located centrally from front to rear in needle hole in throat plate.

Press down upon eccentric V2 and tighten clamping screw S2, Fig. 296.

Press collar W2 up against bracket C4 and tighten screw T2, Fig. 296.

SETTING (Left to Right Position):

Loosen two clamping screws N7, Fig. 296.

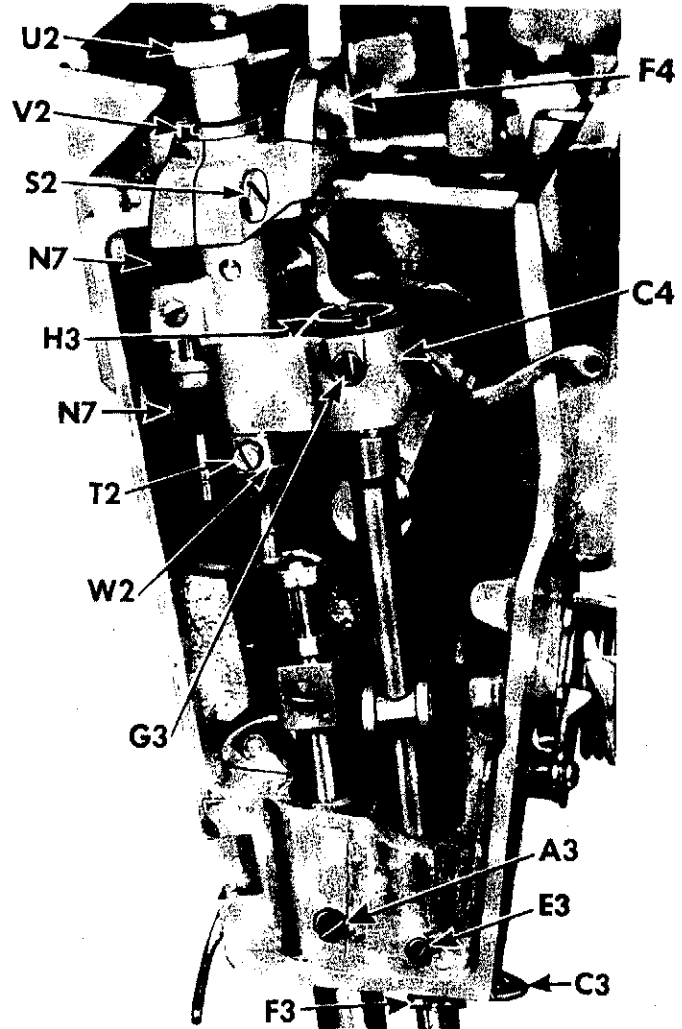

Fig. 296. Centralizing the Needle

Turn hand wheel until needle is in needle hole in throat plate.

While holding needle bar driving arm F4, to keep it from moving, move vibrating bracket C4, Fig. 296, as required to bring needle in center (left to right) of needle hole in throat plate.

Maintain this setting of bracket C4 and tighten two screws N7.

Check timing of hook, as instructed on page 143.

Check front to rear position of hook as instructed on page 144.

TO TIME THE ROTATING HOOK

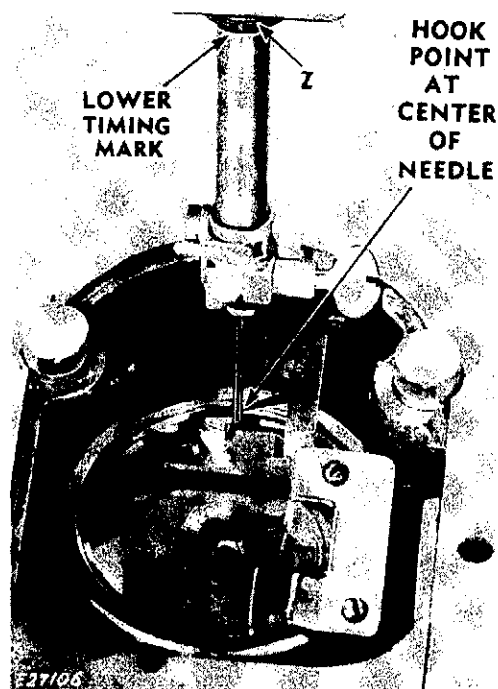

Fig. 297. Hook Correctly Timed

PREPARATION:

Set needle bar at correct height, as instructed on page 134.

Time the needle vibrating mechanism, as instructed on pages 138 to 142.

Select a Size #18 needle, tested for straightness, and insert it correctly in needle bar.

Remove throat plate, bed slide and bobbin case.

Remove bottom cover. (Feed dog is removed in Fig. 297 to show point of hook, but it need not be removed to time the hook.)

Set red lever at #3 position and selector knobs at A and K, as shown in Fig. 295, page 142.

CHECK:

Turn hand wheel over toward operator until LOWER timing mark (see Fig. 297) is level with lower edge of needle bar ball bushing Z, Fig. 297, on upward stroke of needle bar.

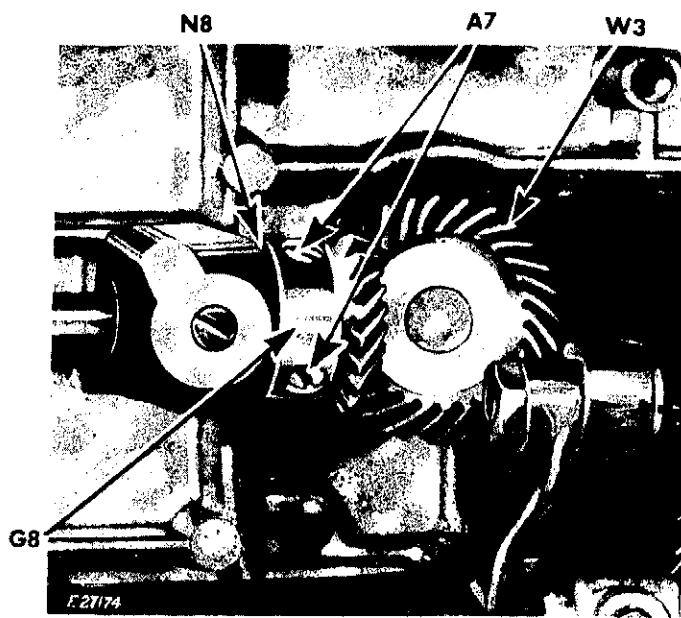

Fig. 298. Adjustment for Hook Timing

At this position of needle bar, point of rotating hook should be at center of needle, as shown in Fig. 297.

SETTING:

Loosen the two set screws A7, Fig. 298 in gear G8.

While maintaining position of needle bar, so that lower timing mark remains level with lower end of bushing Z, Fig. 297 turn gear Y, Fig. 299 A, page 144, on hook shaft, until hook point is located in position shown in Fig. 297.

Securely tighten two set screws A7, Fig. 298 making certain that gears G8 and W3, Fig. 298 are correctly meshed without binding or back lash.

NOTE: Hub of gear G8 should not bear against face of bushing at N8, Fig. 298.

Replace bottom cover, bobbin case, bed slide and throat plate.

TO SET THE POSITION OF THE HOOK POINT TO OR FROM THE NEEDLE

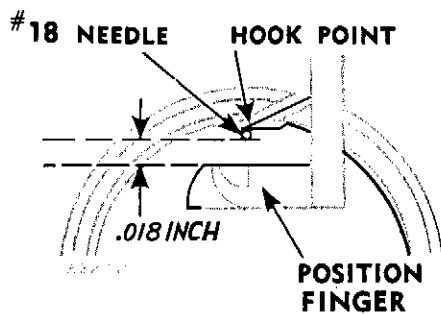

Fig. 299. Correct Position of Hook (Viewed from Above)

PREPARATION:

Set needle bar at correct height as instructed on page 133.

Set red lever at #1 position and stitch selector knobs at A and K.

Select a Size #18 needle, tested for straightness, and insert it correctly in needle bar.

CHECK:

Turn hand wheel over toward operator until point of hook is directly behind needle.

Distance between needle and position finger should be .018 inch, as shown in Fig. 299. (Use feeler gauge to check this distance.)

SETTING:

Loosen two screws O, Fig. 299A.

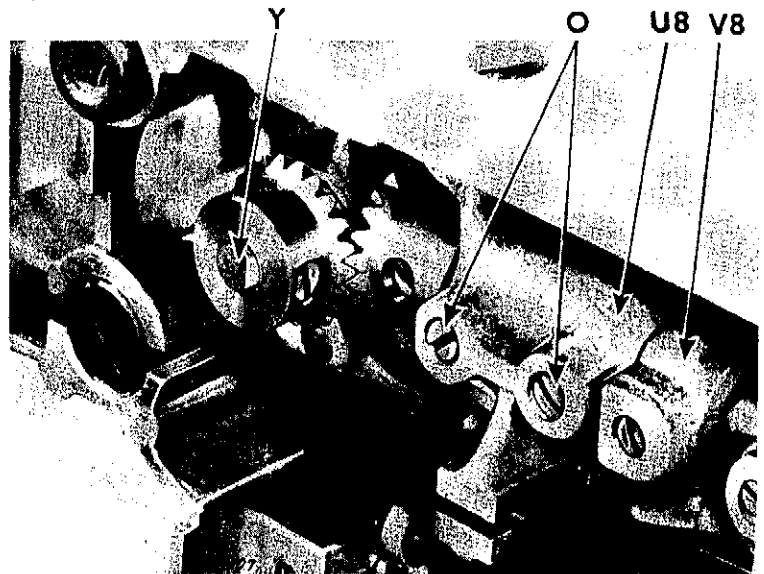

Fig. 299A. Setting the Hook

Move entire hook bracket assembly U8, Fig. 299A, over toward rear, moving hook point away from needle.

Place feeler gauge .018 inch, between needle and position finger.

Move hook bracket assembly U8 over toward front until correct setting is obtained.

Make certain that hook bracket U8 is snug against lug V8, Fig. 299A, on machine. Then securely tighten two screws O.

Check the timing of the hook, as instructed on page 143.

REMOVALS AND REPLACEMENTS

UPRIGHT ARM SHAFT

CAUTION: DO NOT REMOVE the upright arm shaft, from this machine. If this becomes necessary, the machine should be returned to the factory.

Both sets of bevel gears at the ends of the upright arm shaft have been lapped together at the factory and should be kept in mesh throughout all other removals and replacements.

THE MOTOR

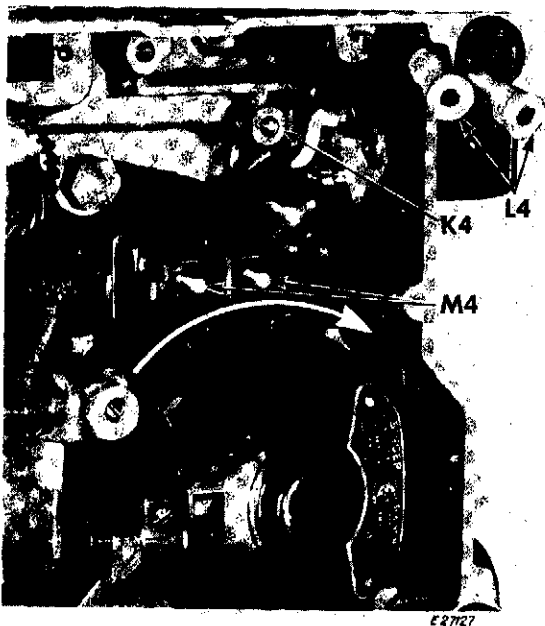

Fig. 300. Removing Motor

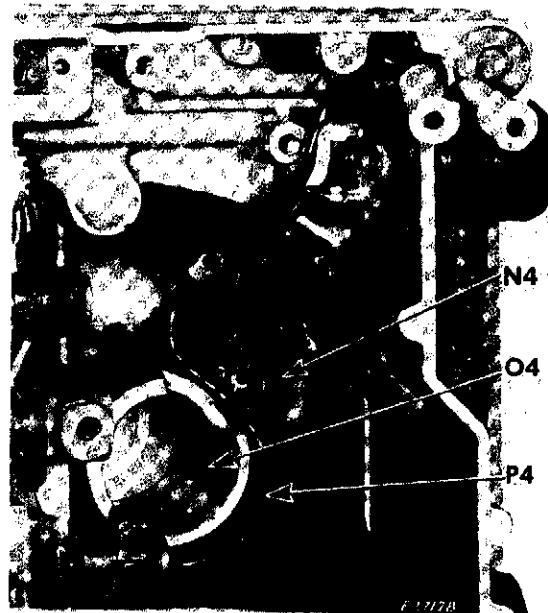

Fig. 301. Location of Wires around Motor

CAUTION:

Remove plug from electric outlet before removing any electrical part from machine.

REMOVAL:

1. Tilt machine back.
2. Remove bottom cover plate.
3. Remove motor hold-down plate, by removing screw from hole **K4**, Fig. 300.
4. Remove two electrical sleeve connections **L4** from motor terminals **M4**, Fig. 300.
5. Slide motor out toward you; rocking it from side to side to facilitate removal.

NOTE: Remove grit or hardened grease from worm gear on motor shaft, before replacing motor.

REPLACEMENT:

1. Make sure that wire **P4**, Fig. 301 is correctly located around and under cylindrical tube **O4**; then up behind three-pin terminal **N4**, as shown in Fig. 301.
2. Slide motor into position, turning hand wheel slightly to facilitate correct gear mesh. Push motor clockwise firmly until motor butts against casting, as shown by curved arrow in Fig. 300.
3. Fit electrical sleeve connections **L4**, Fig. 300 to terminals **M4**.
4. Replace motor hold-down plate and bottom cover plate.

NOTE: See Wiring Diagram on page 162.

REMOVALS AND REPLACEMENTS THE LIGHT FIXTURE

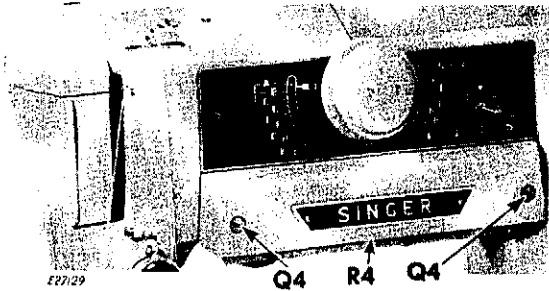

Fig. 302. Lamp Shade

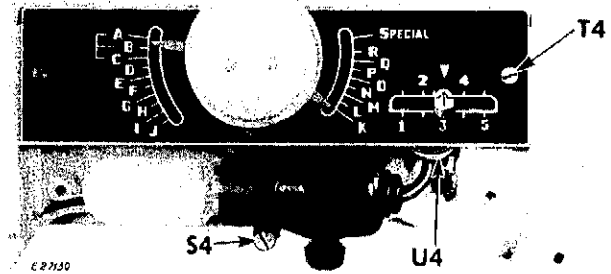

Fig. 303. Light Fixture

REMOVAL:

1. Remove two screws **Q4** and lamp shade **R4**, **Fig. 302**.
2. Remove screw **S4**, **Fig. 303** and allow light fixture to hang from arm.
3. Remove arm top cover.
4. Remove two wire connectors **W4**, **Fig. 304** and disengage light fixture wire from motor leads.
5. Lift oil shield **A5**, **Fig. 304** from arm casting.
6. Remove screw **T4** and lead clip **V4**, **Fig. 304**, **page 147**.
7. Disengage rubber grommet **U4**, **Fig. 303** from arm casting.
8. Remove light fixture with its leads and rubber grommet from machine.

REPLACEMENT:

1. Insert light fixture leads with rubber grommet up through hole provided for them in arm casting at **U4**, **Fig. 303**.
2. Install rubber grommet, as shown in **Fig. 303**.
3. Replace lead clip **V4** and fasten with screw **T4**, **Fig. 304**.
4. Replace oil shield **A5**, as shown in **Fig. 304**, **page 147**.
5. Connect one light fixture lead to each of the motor leads and cap with wire connectors **W4**, as shown in **Fig. 304**.
6. Replace arm top cover.
7. Replace light fixture and fasten with screw **S4**, **Fig. 303**.
8. Replace lamp shade **R4** and fasten with two screws **Q4**, **Fig. 302**.

REMOVALS AND REPLACEMENTS

WIRING HARNESS

(See Wiring Diagram on page 162.)

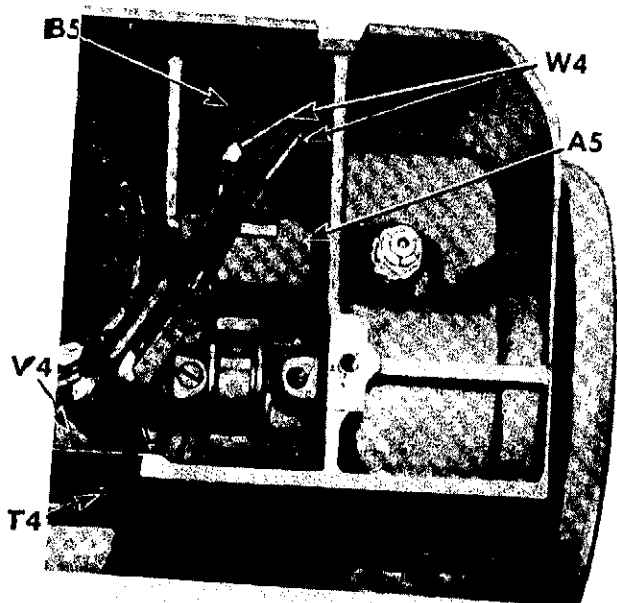

Fig. 304. Wiring at Top of Arm

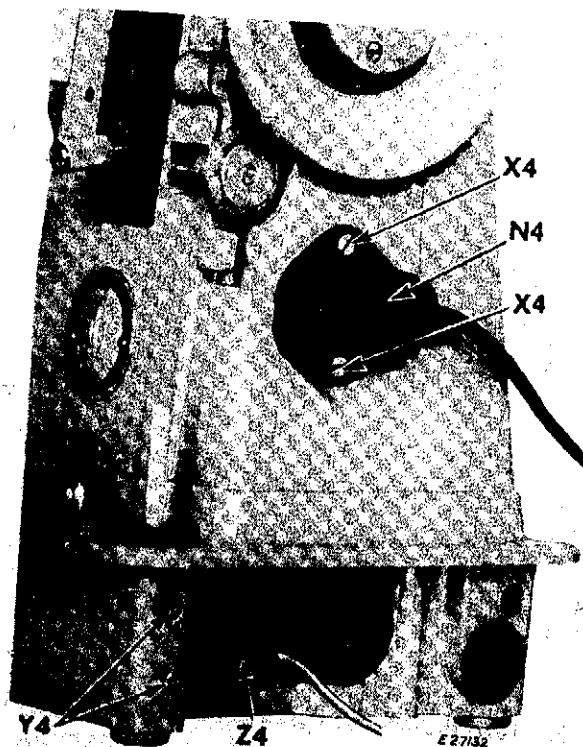

Fig. 305. Terminal Blocks

REMOVAL:

1. Remove male-half of two-pin terminal **Z4**, Fig. 305.
2. Remove female-half of three-pin terminal **N4**, Fig. 305.
3. Remove motor and hold-down plate, as instructed on **page 145**.
4. Remove light fixture, as instructed on **page 146**.
5. Remove two screws **X4**, Fig. 305.
6. Loosen two screws **Y4**, Fig. 305 and push female-half of two-pin terminal into recess beneath bed of machine.
7. Remove two-pin terminal and wire leads through hole in arm provided for three-pin terminal.

REPLACEMENT:

1. Install both terminals with their wire leads in machine, as shown in Fig. 305.
2. Insert sewing light leads up through cavity provided for them in machine arm, as shown at **B5**, Fig. 305.

NOTE: Make certain that light leads are above the three-pin terminal and around the cylindrical tube, as shown in Fig. 301, page 145 and instructed in Step #1 under "REPLACEMENT" on page 145.

3. Fasten male-half of three-pin terminal **N4** to machine with two screws **X4**.
4. Fasten female-half of two-pin terminal **Z4** to machine with two screws **Y4**.
5. Replace light fixture, as instructed on **page 146**.
6. Replace motor and hold-down plate, as instructed on **page 145**.
7. Replace female-half of three-pin terminal at **N4**, Fig. 305.
8. Replace male-half of two-pin terminal at **Z4**, Fig. 305.

REMOVALS AND REPLACEMENTS NEEDLE THREAD TENSION

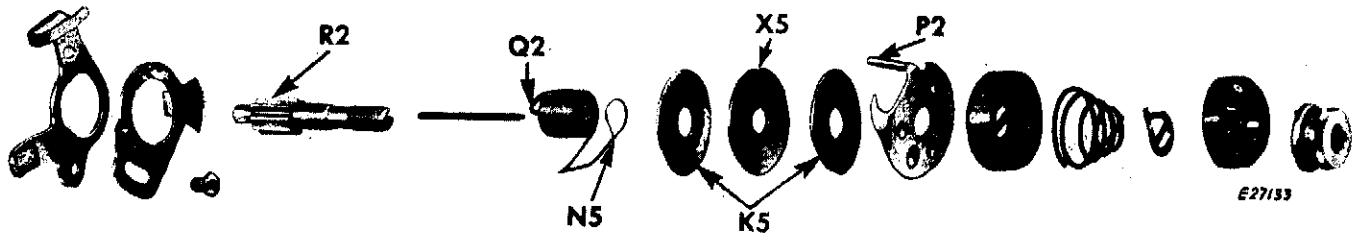

Fig. 306. Needle Thread Tension — Exploded View

REMOVAL:

1. Turn thumb nut **L5**, Fig. 307 to left (counter-clockwise) until "0" on numbered dial **D5** stops at center line on indicator **G5**, Fig. 307.

2. Press in dial **D5**, separating pin **C5** in thumb nut **L5** from hole in dial **D5**; unscrew thumb nut **L5** and remove it from stud **Q2**, Fig. 307.

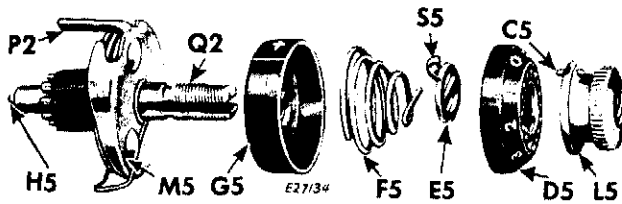

Fig. 307. Needle Thread Tension
Disassembled

NOTE: It is not necessary to remove stud **Q2** from machine to disassemble the thread tension. It is shown removed in Figs. 306 and 307, to illustrate complete assembly. See page 132 for instructions on removal and replacement of entire tension assembly.

3. Other parts may be removed from the stud **Q2** in the order which they are shown in Figs. 306 and 307.

REPLACEMENT:

1. Replace parts on stud **Q2** in the order in which they are shown in Figs. 306 and 307.

2. Make certain that tension releasing pin **H5** is in place as shown in Fig. 307.

3. Place the two tension discs **K5** with their convex faces against flat disc **X5** in center, as shown in Fig. 306. These three tension discs should be behind thread take-up spring thread guard **M5**, as shown in Fig. 307.

4. Pass eyelet **N5**, Fig. 306 of take-up spring under thread guard, having coils of spring above tension discs, as shown in Fig. 308.

REMOVALS AND REPLACEMENTS

NEEDLE THREAD TENSION (Continued)

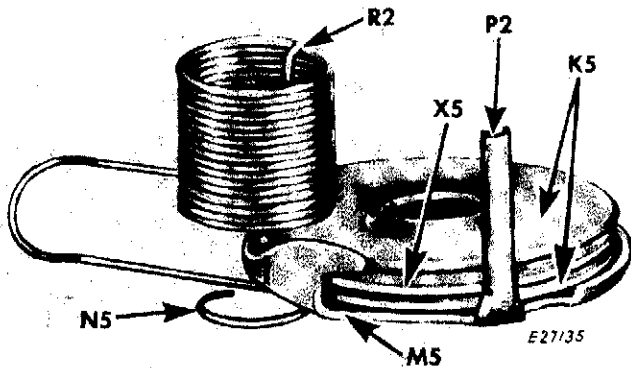

Fig. 308. Tension Disc Assembly

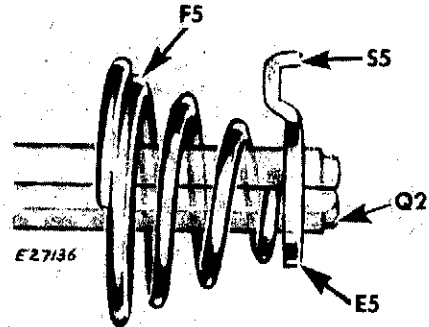

Fig. 309 Stop Washer and Tension Spring

5. Guide the tension disc assembly on the stud **Q2**, so that extension **P2**, Figs. 306, 307 and 308 enters hole, provided for it in machine arm and so that the tail **R2**, Fig. 308, inside the spring coil, enters one of the grooves at the rear of the stud **Q2** (see also page 132).

6. Replace indicator **G5**, Fig. 307 with its large open side facing the split end of the stud — with plus and minus mark on top — “minus” at left and “plus” at right.

7. Hold these assembled parts against shoulder of stud, insert tension spring **F5**, Fig. 307 in indicator, with first half-coil of spring **F5** straddling lower half of split stud.

8. Guide the stop washer on the stud **Q2** so that extension **S5** will be above stud.

NOTE: When spring and stop washer are correctly assembled, extension **S5** will clear the first half-coil of the tension spring, as shown in Fig. 309.

9. Place the numbered dial **D5**, Fig. 307 so that the number “2” is opposite stop washer extension **S5**.

10. Push dial **D5** to compress spring to facilitate replacement of thumb nut **L5**.

11. Replace thumb nut **L5**, carefully guiding pin **C5** into one of the holes in dial **D5**.

12. Adjust assembly as instructed on pages 132 and 133.

REMOVALS AND REPLACEMENTS HAND WHEEL AND COUNTERBALANCE

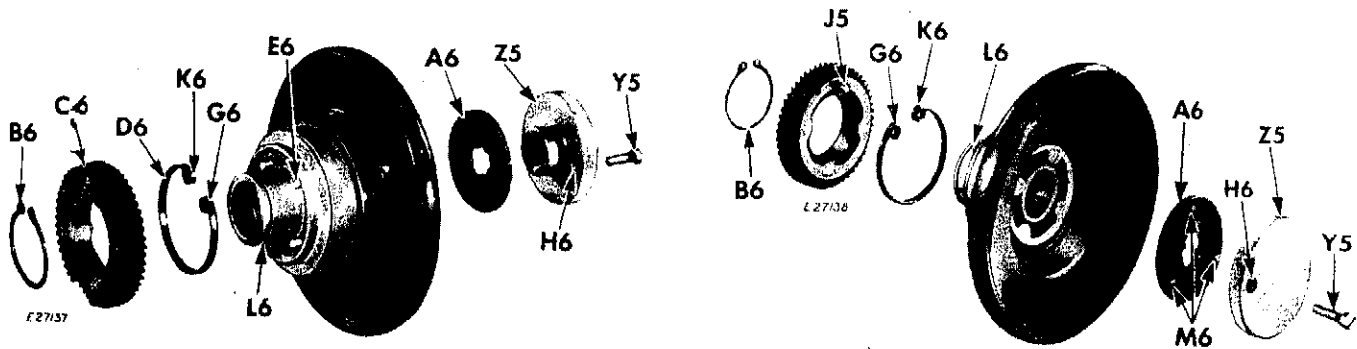

Fig. 310. Exploded Views of Hand Wheel Assembly

REMOVAL AND DISASSEMBLY:

1. Remove small screw **Y5** from stop motion nut **Z5**, Fig. 310.
2. Remove nut **Z5** and clamp washer **A6** from arm shaft.
3. Remove hand wheel assembly from arm shaft.
4. Remove screw **P5** and counterbalance **O5**, Fig. 311 from arm shaft.
5. Remove hand wheel snap ring **B6**, Fig. 310 from hand wheel assembly with expansion pliers.
6. Slip gear **C6** from hand wheel.

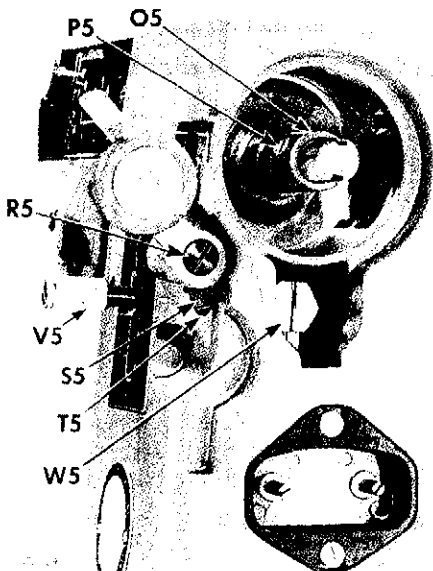

Fig. 311. Arm Shaft Counterbalance

7. Remove gear spring **D6**, Fig. 310 from stud **E6** of hand wheel.

ASSEMBLY AND REPLACEMENT:

1. Place gear spring **D6**, Fig. 310 into hand wheel so that loop **G6** of spring grasps middle stud **E6**, Fig. 310 in hand wheel.
2. Place gear **C6** on hand wheel, with stud **J5** inserted in loop **K6**, Fig. 310 of gear spring.
3. Replace snap ring **B6** on hand wheel, setting ring in groove **L6**, Fig. 310 on hand wheel sleeve.
4. Replace counterbalance **O5**, Fig. 311.
5. Insert screw **P5** through counterbalance **O5** and hole provided for it on arm shaft, as shown in Fig. 311.
6. Replace hand wheel assembly on arm shaft.
7. Replace stop motion clamp washer **A6**, Fig. 310 (three short studs **M6** facing outward).
8. Replace and tighten stop motion nut **Z5** and replace screw **Y5** in hole **H6**, Fig. 310, in stop motion nut.

NOTE: If studs **M6** interfere with screw **Y5** when stop motion nut **Z5** is loosened to release hand wheel, remove screw **Y5** and nut **Z5**. Remove washer **A6**, rotate it 180° and replace it on arm shaft. Replace nut **Z5** and screw **Y5**.

REMOVALS AND REPLACEMENTS

BOBBIN WINDER

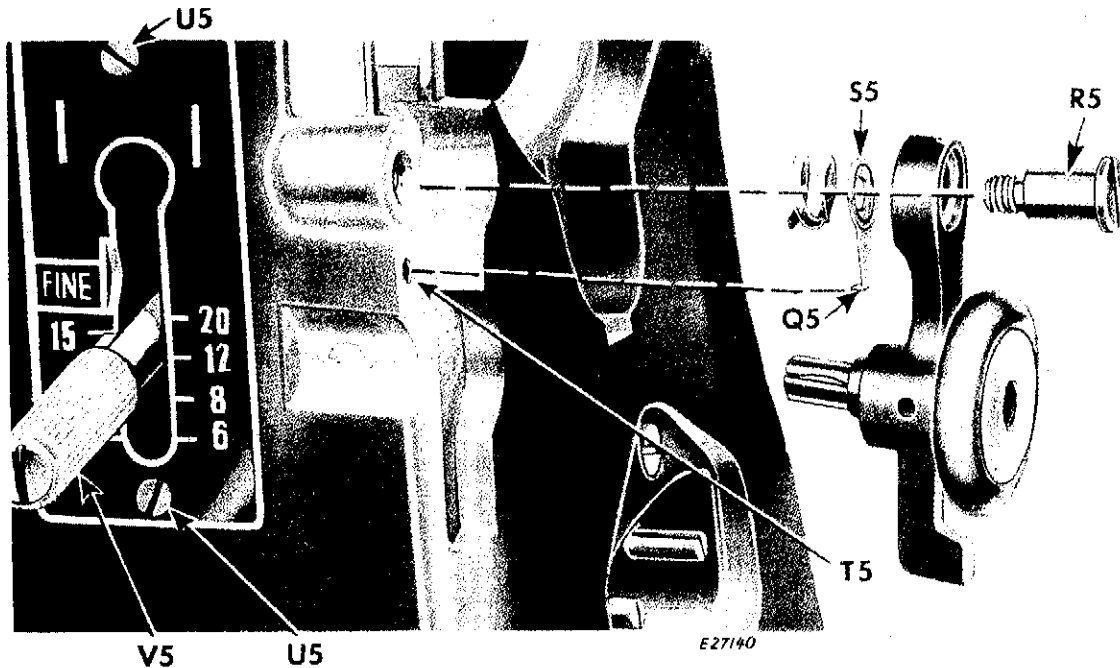

Fig. 312. Bobbin Winder Removed

REMOVAL AND DISASSEMBLY:

1. Remove hand wheel, as instructed on **page 150**.
2. Remove screw **R5**, **Fig. 312**.
3. Disassemble as shown in **Fig. 312**.

ASSEMBLY AND REPLACEMENT:

1. Assemble in order indicated in **Fig. 312**.

2. Replace bobbin winder on machine arm, fastening it to machine arm by means of hinge screw **R5**.

3. Make sure that projection **Q5** on frame spring **S5** is inserted in hole **T5** in machine arm.

4. Tighten hinge screw **R5**.

5. Replace hand wheel as instructed on **page 150**.

STITCH REGULATOR

REMOVAL:

1. Remove hand wheel, as instructed on **page 150**.
2. Remove two screws **U5**, **Fig. 312**, holding stitch regulator plate.
3. Move feed regulator **V5**, **Fig. 312** to bottom of slot in indicator plate.
4. Remove large screw stud **W5**, **Fig. 311** with its spring and washer from arm casting.
5. Pull entire regulator, with stitch plate out the front of the machine arm.

REPLACEMENT:

1. Install regulator **V5**, **Fig. 312** in arm, making certain that slide fits on block on feed fork connection.
2. Replace large stud **W5**, **Fig. 311** with spring and washer, so that stud holds slide to inside of arm.
3. Set indicator plate in position on front of machine arm and replace two screws **U5**.
4. Tighten screws **U5**.
5. Replace hand wheel, as instructed on **page 150**.

REMOVALS AND REPLACEMENTS

THROAT PLATE POSITION BRACKET

(See Figs. 313 and 314)

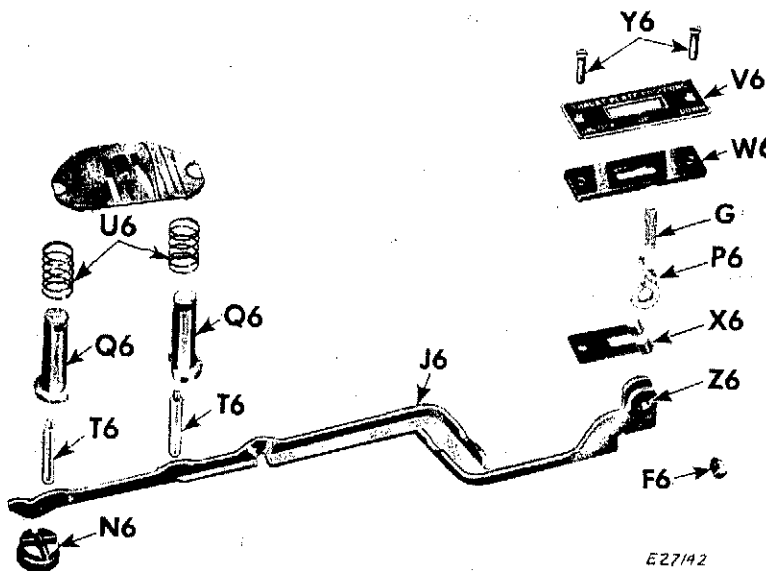

Fig. 313. Exploded View of Throat Plate Position Bracket

REMOVAL:

1. Remove bottom cover plate.
2. Remove throat plate.
3. Set position lever **G** in "down" position and while pressing left hand end of bracket **J6** toward underside of machine bed, remove adjusting screw **N6**.

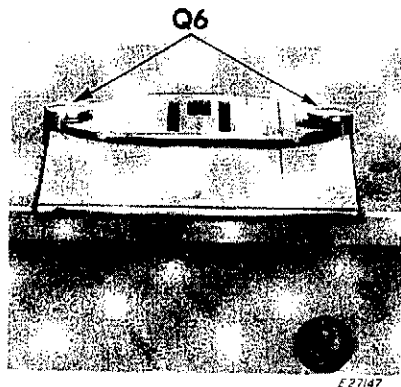
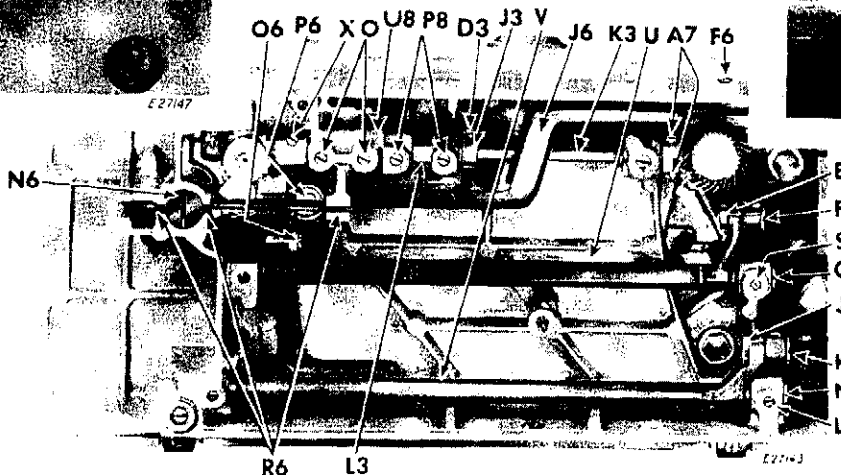
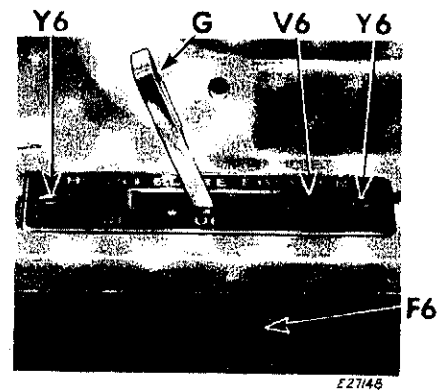

Fig. 314. Throat Plate Position Bracket Assembled



4. Swing bracket **J6** outward, away from machine bed and remove two throat plate clamps **Q6** with pins **T6** and springs **U6** from machine.

5. Set position lever **G** in "up" position, as shown in inset at right of **Fig. 314**, and remove screw **F6** at front of machine bed.

6. Remove bracket **J6**.

7. Remove two screws **Y6** at top of indicator plate **V6**.

8. Lift indicator plate **V6**, stop plate **W6**, spring **X6** and lever **G**, from bed of machine.

REPLACEMENT:

Replace throat plate position bracket in the reverse order of its removal. Observe the following —

Lever **G** and spring **X6** should be replaced with the curved portions of spring under cross-piece **P6** of lever **G**. (Remainder of spring should extend toward left).

Hole **Z6** of bracket **J6** should be aligned with hole at bottom of lever **G** and with hole in front of machine bed, as shown in inset at top right of **Fig. 314**. Then fasten lever to bracket with screw **F6**.

Bracket **J6** must be inserted in grooves **R6** under machine bed, as shown in **Fig. 314**.

Adjusting screw **N6** should be tightened flush with bottom of casting, as shown in **Fig. 314**.

REMOVALS AND REPLACEMENTS

FEED LIFTING ROCK SHAFT

(See Fig. 314, page 152)

REMOVAL:

1. Remove bottom cover plate.
2. Remove motor hold-down plate and motor as instructed on **page 145**.
3. Remove nut **E** and eccentric **F**, **Fig. 314**, disengaging feed lifting rock shaft **U** from upright connecting rod.
4. Loosen set screw **S** and remove screw center **Q**.

5. Remove screw stud **O6**, disengaging feed bar.
6. Remove feed lifting rock shaft **U**.

REPLACEMENT:

1. Install feed lifting rock shaft **U** in reverse order instructed for removal.
2. Adjust feed dog, as instructed on **pages 129, 130 and 136**.
3. Replace motor, as instructed on **page 145**.

FEED ROCK SHAFT ASSEMBLY

(See Fig. 314, page 152)

REMOVAL:

1. Remove bottom cover plate.
2. Remove motor hold-down plate and motor, as instructed on **page 145**.
3. Remove feed lifting rock shaft **U**, as instructed above.
4. Remove nut **J**, **Fig. 314**.
5. Remove eccentric **K**, disengaging feed rock shaft **V** from feed fork connection.
6. Loosen set screw **L** and remove screw center **N**.

7. Remove feed rock shaft **V** with feed bar and feed dog.

REPLACEMENT:

1. Install feed rock shaft **V** with feed bar and feed dog in reverse order instructed for removal.
2. Install feed lifting rock shaft **U**, as instructed above.
3. Adjust feed dog, as instructed on **pages 129, 130 and 136**.
4. Replace motor, as instructed on **page 145**.

HOOK DRIVING SHAFT

(See Fig. 314, page 152)

REMOVAL:

1. Remove rotating hook as instructed on **page 154**.
 2. Loosen set screw **D3**, **Fig. 314** on collar **J3**.
 3. Loosen two set screws **A7** in bevel gear.
- NOTE: KEEP THIS GEAR IN MESH WITH MATED GEAR ON UPRIGHT ARM SHAFT.**
4. Remove motor, as instructed on **page 145**.
 5. Remove two-pin terminal, as instructed on **page 147**.
 6. Loosen set screw **X** and remove gear from left end of hook driving shaft.

7. Slide shaft **K3** toward right and out of machine through hole provided for two-pin terminal in bed of machine.

REPLACEMENT:

1. Replace hook driving shaft in reverse order of its removal.

NOTE: Flat on shaft **K3** must be toward left end of machine (hook bracket end), so that set screw **X**, **Fig. 315** may be fastened upon it.

2. Replace hook as instructed on **page 154**.
3. Adjust and time hook assembly, as instructed on **pages 136, 143 and 144**.

REMOVALS AND REPLACEMENTS

CAUTION: Hook shaft gear Y, Fig. 315, and hand wheel gear C6, Fig. 310, page 150, may be removed to facilitate adjustments. **DO NOT DISTURB THE MESH OF ANY OTHER GEAR IN THIS MACHINE.** All other gears are mated and correctly timed. Replacements should be made at the factory.

ROTATING HOOK AND POSITION FINGER

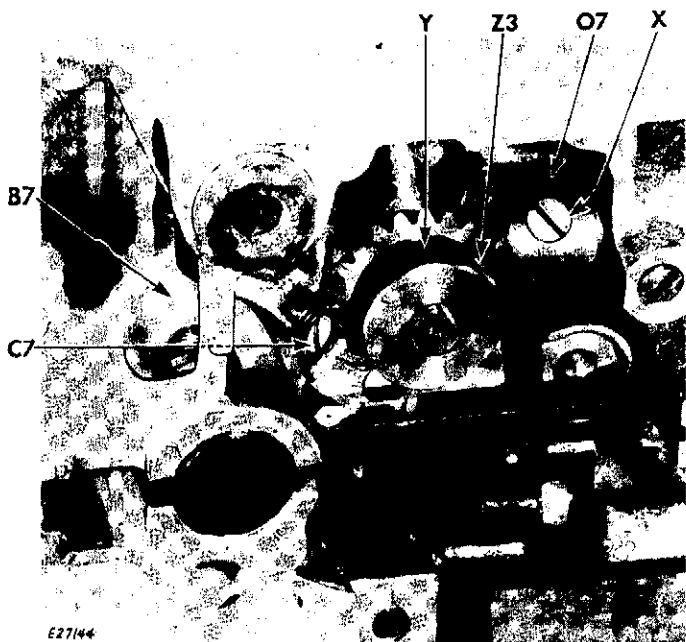

Fig. 315. Hook Shaft Bevel Gears

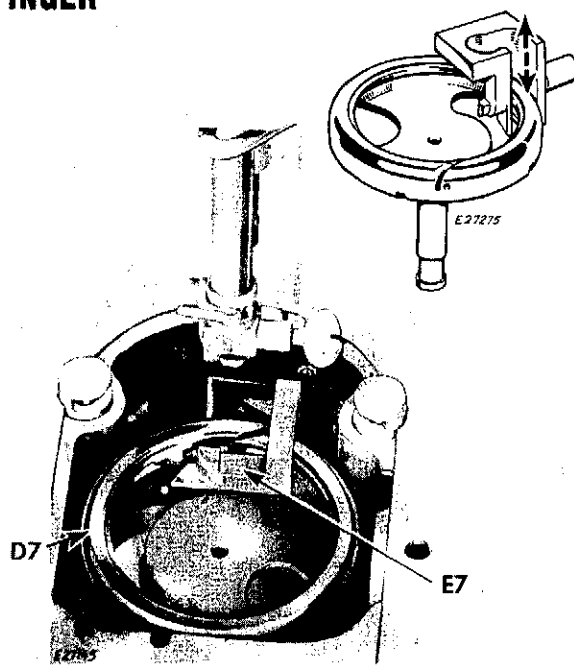

Fig. 316. Rotating Hook

REMOVAL:

1. Remove needle, presser foot, throat plate, bed slide, bobbin case, feed dog and cushion spring bracket.

2. Remove bottom cover plate.

3. **Mark the two bevel gears Y and O7, Fig. 315, with chalk or crayon, on one tooth of one gear and the corresponding space for that tooth between the teeth of the other gear, to facilitate re-assembly.**

4. Loosen set screw Z3, Fig. 315.

5. Remove bevel gear Y from hook shaft.

6. Insert screwdriver through hole B7, Fig. 315, and loosen set screw C7.

7. Remove rotating hook assembly D7, Fig. 316.

8. Remove position finger from hook, as shown in inset at top right corner of Fig. 316. **Keep position finger away from hook point.**

REPLACEMENT:

1. Install position finger E7 on hook, as shown in Fig. 316. Slide position finger down and around ring on hook at point shown in inset at top right cor-

ner of Fig. 316 keeping it away from hook point. Then move position finger to correct position at E7, Fig. 316.

2. Install rotating hook assembly D7 with position finger E7, as shown in Fig. 316.

3. Press down on finger E7 and tighten set screw C7.

4. Replace bevel gear Y on hook shaft.

5. Using marks, previously made at removal, as a guide, mesh the two hook shaft bevel gears Y and O7.

6. Turn hook shaft until flat is under set screw Z3 in gear Y and tighten screw Z3.

NOTE: The two set screws X and Z3 on the two bevel gears should be in line when hook shaft and hook driving shaft are correctly installed.

7. Check and adjust hook, as instructed on pages 136, 143 and 144.

8. Replace bottom cover plate.

9. Replace cushion spring bracket, feed dog, bobbin case, bed slide, throat plate, presser foot and needle.

REMOVALS AND REPLACEMENTS

FEED LIFTING ROCK SHAFT CONNECTING ROD

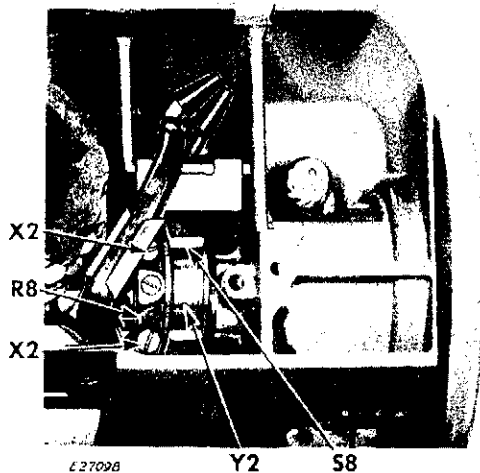

Fig. 317. Feed Lifting Connecting Rod on Arm Shaft

REMOVAL:

1. Remove arm top cover.
2. Remove two cap screws **X2**, **Fig. 317** and remove connecting rod cap **R8**, **Fig. 317**.
3. Remove bottom cover plate and motor, as instructed on **page 145**.
4. Remove nut **E** and eccentric stud **F**, **Fig. 318**, disengaging connecting rod **Q8** from feed lifting rock shaft **U**, **Fig. 318**.
5. Remove connecting rod **Q8** from bottom of machine.

REPLACEMENT:

1. Insert connecting rod **Q8**, **Fig. 318** into upright arm through bottom of machine, so that it fits around bottom half of gear hub on eccentric **Y2**,

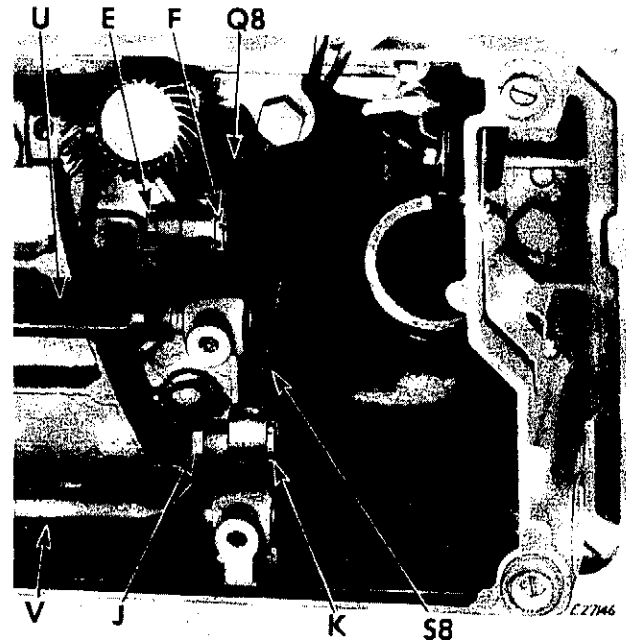

Fig. 318. Connections beneath Machine Bed

Fig. 317 and so that the oil hole in the lower end the rod faces the front edge of machine bed.

2. Replace cap **R8** over top half of gear hub and fasten cap to rod with two screws **X2**, **Fig. 317**.
3. Replace stud **F** and nut **E**, **Fig. 318**, engaging connecting rod **Q8** to shaft **U**.
4. Adjust feed dog height, as instructed on **page 129**.
5. Replace motor and bottom cover plate, as instructed on **page 145**.
6. Replace arm top cover.

FEED FORKED CONNECTION

REMOVAL:

1. Remove stitch regulator, as instructed on **page 151**.
2. Remove motor, as instructed on **page 145**.
3. Remove nut **J** and stud **K**, **Fig. 318**, disengaging feed forked connection **S8** from feed rock shaft **V**, **Fig. 318**.
4. Remove feed forked connection **S8** from upright arm, through bottom of machine.

REPLACEMENT:

1. Insert feed forked connection **S8** into upright

arm, through bottom of machine, so that it fits around eccentric **Y2** from bottom, as shown in **Fig. 317**.

2. Engage feed forked connection **S8** with feed rock shaft **V**, **Fig. 318** and fasten with stud **K** and nut **J**.
3. Replace stitch regulator, as instructed on **page 151**.
4. Adjust position of feed dog, as instructed at bottom of **page 129**.
5. Replace motor, as instructed on **page 145**.

REMOVALS AND REPLACEMENTS

NEEDLE BAR

(See Fig. 319)

REMOVAL:

1. Remove needle clamp and needle clamp thread guide.
2. Remove arm top cover and face plate.
3. Loosen screw **W** and lift needle bar **J7**, up through bushings and out of machine.

REPLACEMENT:

1. Insert needle bar down through bushings, as shown in Fig. 319.
2. Replace needle clamp, needle clamp thread guide, and face plate.
3. Adjust needle bar height, as instructed on page 133.
4. Securely tighten set screw **W**.
5. Replace face plate and arm top cover.

PRESSER BAR

(See Fig. 319)

REMOVAL:

1. Open the face plate.
2. Remove presser foot and thumb screw.
3. Remove pressure regulating thumb screw **U2**.
4. Remove extension pin **M7** and extension pin seat **K7**.
5. Loosen set screw **C**, and remove presser bar guide bracket **L7**.
6. Loosen screw **A3** and remove presser bar bushing **B3**, lower thread guide **C3** and presser bar **D**.

REPLACEMENT:

1. Replace presser bar assembly in the reverse order of its removal.

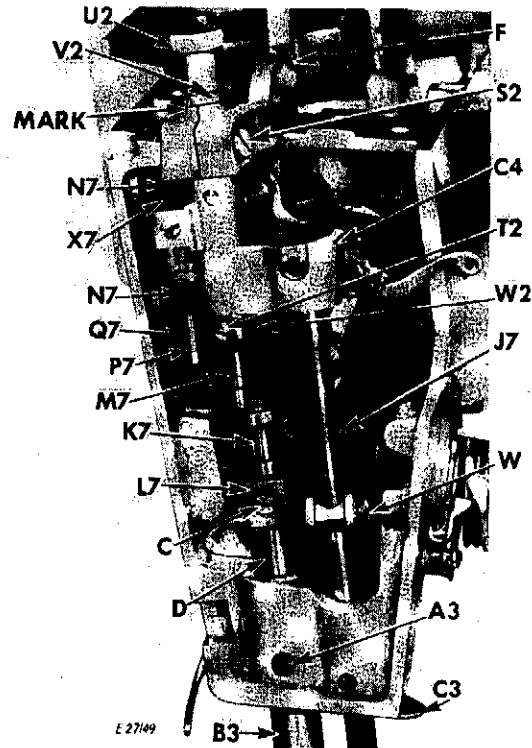

Fig. 319. Needle Bar Assembly

2. Replace thread guide **C3**, as instructed on page 135.
3. Replace presser foot and presser foot thumb screw.
4. Replace pressure regulating thumb screw **U2**, Fig. 319.
5. Adjust presser foot at correct height, as instructed on page 128.
6. Align presser foot with slots for feed dog in throat plate, as instructed on page 128, and securely tighten set screw **C**, Fig. 319.

NEEDLE BAR VIBRATING BRACKET

(See Fig. 319)

REMOVAL:

1. Remove arm top cover and face plate.

2. Remove thumb screw **U2**.
3. Remove extension pin **M7**.

4. Mark edge of eccentric hinge pin **V2** as shown in **Figs. 319** and **320** so that its position in relation to casting may be readily regained.

5. Unhook spring **P7** from hinge pin **Q7**, **Fig. 320**.

6. Loosen screw **K9**, **Fig. 320** and remove pin **Q7**.

7. Loosen set screw **T2** and remove collar **W2**, **Fig. 320**.

8. Loosen clamping screw **S2** and remove large, eccentric hinge pin **V2**.

9. Remove needle bar vibrating bracket **C4** from machine head.

REPLACEMENT:

Install needle bar vibrating bracket **C4** in the reverse order of its removal. Observe the following —

Spring **P7** must be hooked around hinge pin **Q7**, as shown in **Fig. 320**.

Make certain that when set screw **T2** is tightened, bracket **C4** moves without looseness or binding.

Turn hinge pin **V2** so that marks made in Step 4 of "Removal" coincide. Then securely tighten clamping screw **S2**.

NEEDLE THREAD TAKE-UP

REMOVAL:

1. Remove arm top cover and face plate.

2. Remove needle bar vibrating bracket, as instructed on **page 156** and above.

3. Loosen set screw **H7**, **Fig. 320** over hinge stud **R7**.

4. Loosen small set screw **F7** in needle bar crank **S7**, through hole in top of casting, as shown in **Fig. 320**.

5. Withdraw needle thread take-up **T7**, with link **U7**, hinge stud **R7** and stud **V7**, **Fig. 320** from machine head.

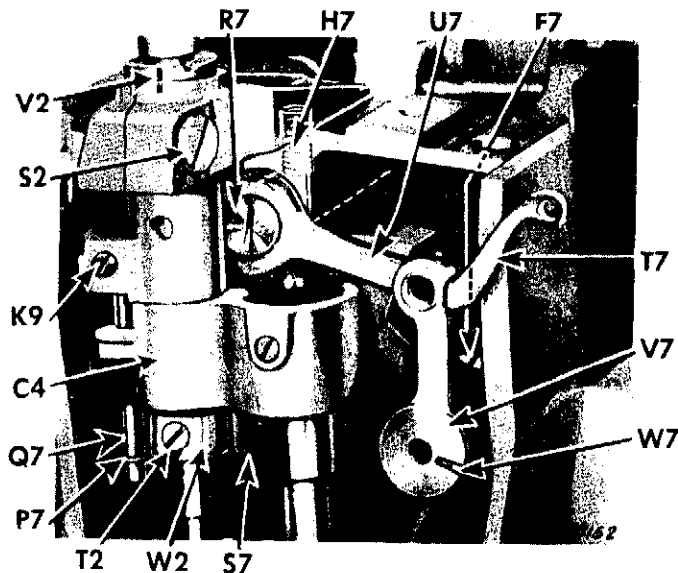

Fig. 320. Needle Thread Take-up

REPLACEMENT:

1. Install needle thread take-up in reverse order of its removal, outlined above.

2. Locate mark **W7** on stud **V7**, as shown in **Fig. 320**, in relation to its set screw **F7**. Press firmly upon stud **V7** and tighten set screw **F7**.

3. Turn hand wheel while setting hinge stud **R7**, to make sure there is no end play nor binding; then tighten set screw **H7**, **Fig. 320**.

4. Replace needle bar vibrating bracket as instructed above.

5. Replace arm top cover and face plate.

REMOVALS AND REPLACEMENTS CAM STACK

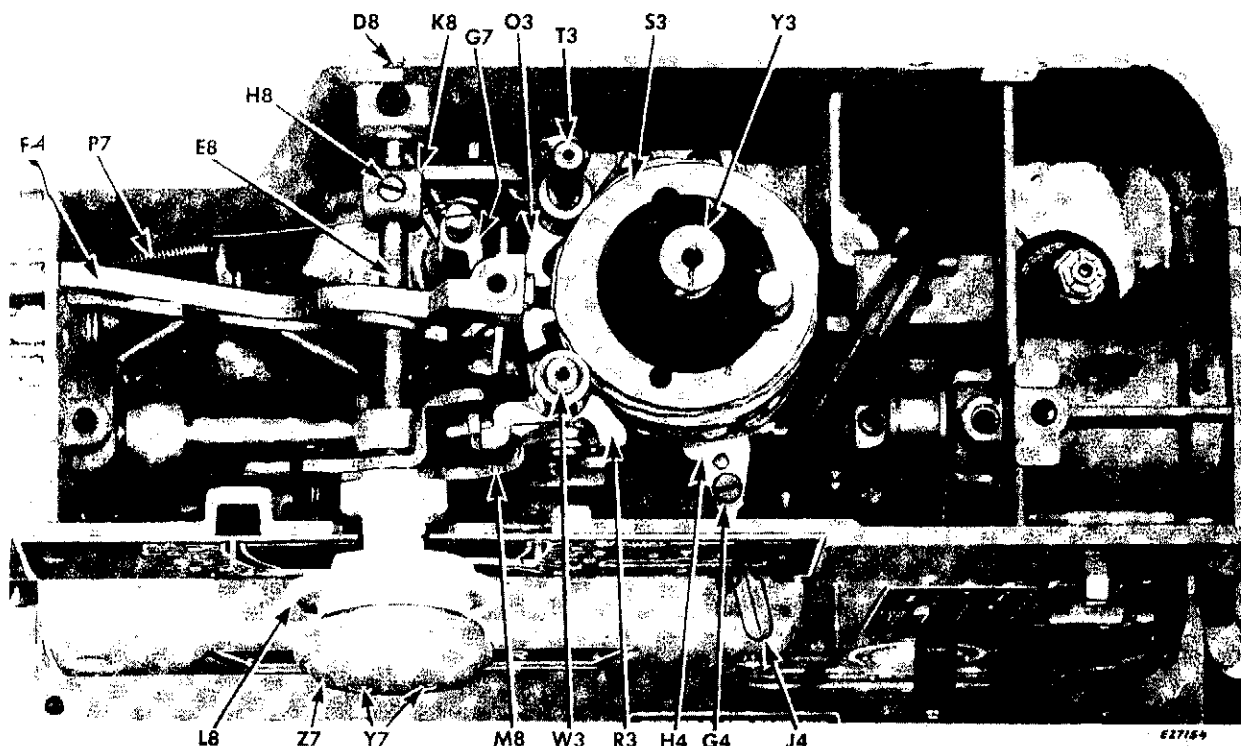

Fig. 321. Cam Stack and Selector Arm Shaft

REMOVAL:

1. Set stitch selector knobs at **A** and **K**, as shown in Fig. 295, page 142.
2. Remove arm top cover and special disc.
3. Remove large screw stud **Y3**, Fig. 321 with spring and remove cam stack **S3**.

REPLACEMENT:

1. Replace cam stack, meshing it with worm gear on arm shaft, by working it back and forth.
2. Replace screw stud **Y3** and spring.
3. Replace special disc and arm top cover.

CAM SELECTOR ARM SHAFT AND FOLLOWERS

REMOVAL:

1. Remove cam stack, as instructed above.
2. Remove two screws **Y7** and knob **Z7**, Fig. 321.
3. Remove screw **A8**, indicator **B8** and spring **C8**, Fig. 322.
4. Remove screw **D8**, Fig. 321, at rear of selector arm shaft **E8**.
5. Remove screw **H8** and withdraw shaft **E8** from front of arm, releasing rear selector arm **K8**, and front selector arm and knob **L8**, Fig. 321.
6. Withdraw knob **L8** from machine.
7. Remove followers **O3** and **R3**, Fig. 321.

REPLACEMENT:

1. Replace followers **O3** and **R3**, as shown in Fig. 321.
2. Replace knob **L8** so that bracket on front selector arm **M8** slides into its slot in front follower **R3**, Fig. 321.
3. Replace selector arm shaft **E8** slipping it through front selector arm knob **L8** and rear selector arm **K8**, Fig. 321. Make certain that bracket on rear selector arm **K8** slides into its slot in follower **O3**.

4. Replace and securely tighten screw **H8**, Fig. 321 so that screw clamps down on counterbore on shaft.
5. Replace spring **C8** and indicator **B8**, Fig. 322. Fasten with screw **A8**, Fig. 322.
6. Replace screw **D8**, Fig. 321 on rear of arm selector shaft.
7. Replace knob **Y7**, Fig. 321. Fasten knob to indicator **B8**, Fig. 322 with two screws **Z7**, Fig. 321.
8. Replace cam stack, as instructed above.

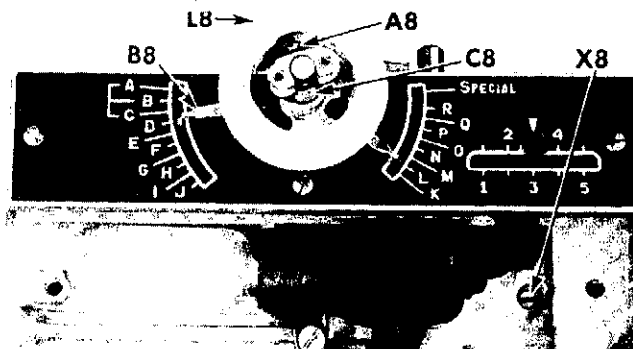

Fig. 322. Removing Selector Arm Shaft

REMOVALS AND REPLACEMENTS

NEEDLE BAR DRIVING ARM

REMOVAL:

1. Remove arm top cover and face plate.
2. Remove cam selector arm shaft, as instructed on **page 158**.
3. Remove needle bar vibrating bracket, as instructed on **pages 156 and 157**.
4. Lift needle bar driving arm, **F4**, **Fig. 323** from machine.

REPLACEMENT:

1. Install needle bar driving arm **F4** in arm of

machine, so that ball pivot **Z8**, **Fig. 323** rides in socket provided for it in pattern selector **Y8**, as shown in **Fig. 323**.

CAUTION: Make certain tension arm **G7**, **Fig. 323** is in correct position in relation to needle bar driving arm, as shown in **Fig. 323**.

2. Replace cam selector arm shaft as instructed on **page 158**.

3. Replace needle bar vibrating bracket, as instructed on **page 157**.

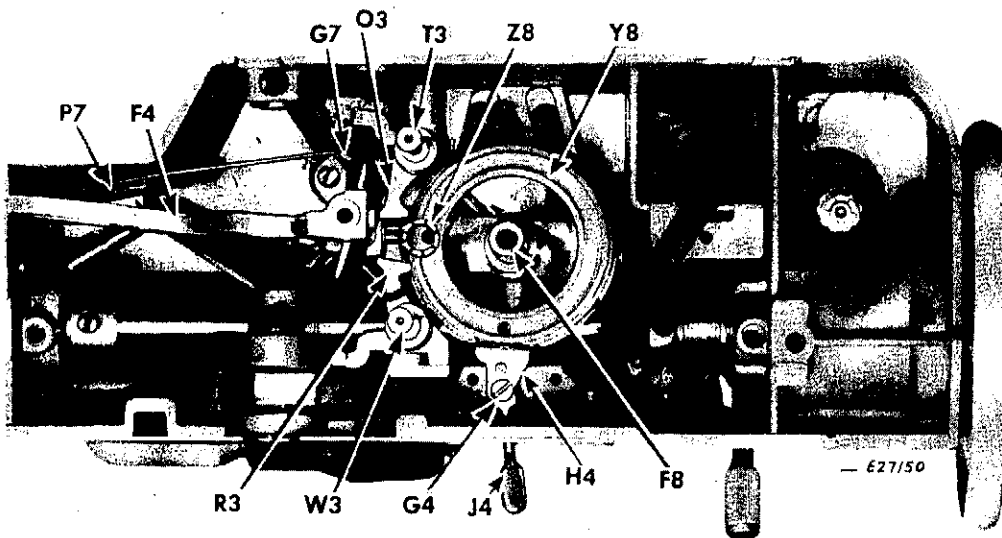

Fig. 323. Showing Location of Ball Pivot on Driving Arm

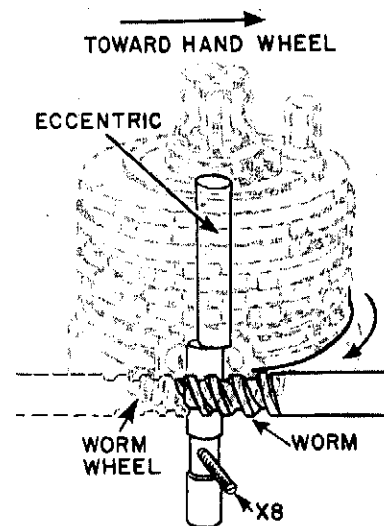

Fig. 323A. Eccentric Worm Wheel Shaft and Worm Wheel

BIGHT AMPLITUDE AND PATTERN SELECTOR

(See Fig. 323)

REMOVAL:

1. Remove arm top cover, face plate and lamp shade.
2. Set stitch selector knobs at **A** and **K** as shown in **Fig. 295, page 142**.
3. Remove spring **P7**, **Fig. 323**.
4. Remove screw **G4** from bight amplitude bracket **H4**.
5. Remove red lever **J4**.
6. Loosen set screw **X8**, **Fig. 322, page 158** and remove entire cam stack assembly **S3** with worm wheel eccentric shaft **F8**, **Fig. 323** and screw stud **Y3**, **Fig. 321, page 158**.
7. Remove bight amplitude and pattern selector **Y8** from machine arm.

REPLACEMENT:

Replace bight amplitude and pattern selector in the reverse order of its removal. Observe the following —

1. Assemble cam stack as a complete unit to machine. Upper eccentric half of eccentric worm wheel shaft **F8** should be turned toward the hand wheel end of shaft, as shown in **Fig. 323A**.

2. Make certain that needle bar driving arm ball bearing pivot **Z8** is engaged with pattern selector, as shown in **Fig. 323**.

3. Set mesh between worm and worm wheel by turning shaft **F8** clockwise until worm and worm wheel are engaged.

4. Turn shaft **F8** so that there is no binding when arm shaft is rotated and there is a minimum amount of back lash between worm and worm wheel.

5. Tighten set screw **X8**, **Fig. 322** at front of machine arm.

6. Replace spring **P7**, **Fig. 323**.

7. Replace lever **J4** and screw **G4**.

8. Adjust machine, as instructed on **page 141**.

9. Replace face plate, arm top cover and lamp shade.

REMOVALS AND REPLACEMENTS

HORIZONTAL ARM SHAFT

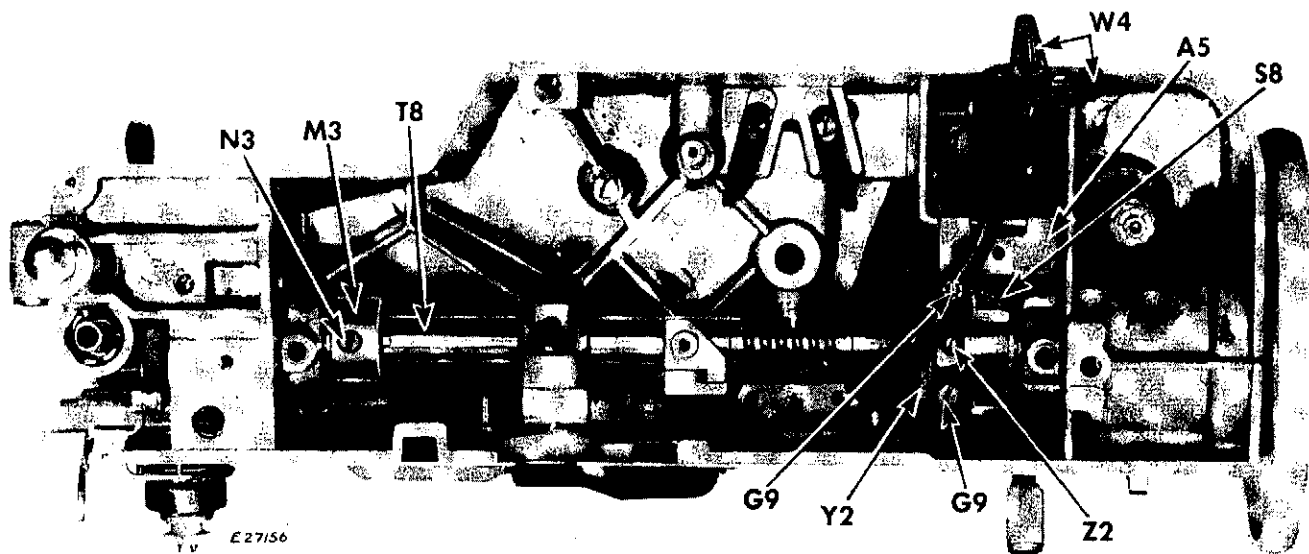

Fig. 324. Horizontal Arm Shaft

REMOVAL: (See "CAUTION" at top of page 154.)

1. Remove arm top cover and face plate.
2. Remove needle bar vibrating bracket and needle thread take-up, as instructed on pages 156 and 157.
3. Remove cam stack, as instructed on page 158.
4. Remove hand wheel and counter-balance, as instructed on page 150.
5. Remove wire connectors **W4**, disengaging motor leads from light leads.
6. Lift oil shield **A5** from arm casting.
7. Loosen screw **N3** in collar **M3**, Fig. 324.

NOTE: KEEP GEARS IN MESH AT ALL TIMES.

8. Remove two screws **G9** and remove connecting rod cap.
9. Using a 1/2 inch drift pin or another arm shaft (for Machine 401) drive arm shaft **T8**, Fig. 324, out of machine arm from **right to left**. Hold gear **Y2** in mesh with gear on upright arm shaft.

REPLACEMENT:

1. Insert a new arm shaft **T8**, Fig. 324, in head of machine at left end and push it into machine arm

from **left to right**, through collar **M3**, bevel-gear-and-eccentric **Y2** and feed forked connection **S8**, as shown in Fig. 324.

2. Make certain flat on arm shaft is under set screw **N3**, Fig. 324; then, while pressing firmly on needle bar crank, hold collar against casting and tighten set screw **N3**.
3. Make certain that feed timing screw **Z2** is over groove provided for it in arm shaft. Tighten screw **Z2**.
4. Replace connecting rod cap and fasten with two screws **G9**.
5. Replace oil shield **A5**, as shown in Fig. 324.
6. Connect motor leads to light leads and replace wire connectors **W4**, as shown in Fig. 324.
7. Replace hand wheel and counter-balance, as instructed on page 150.
8. Replace cam stack, as instructed on page 158.
9. Replace needle thread take-up and needle bar vibrating bracket, as instructed on page 157.
10. Adjust machine as instructed on page 137.
11. Replace arm top cover and face plate.

HINTS FOR ADJUSTERS AND MECHANICS

CHECK THESE POINTS WHEN A MACHINE BINDS

1. Sprung or cracked bed or arm incurred during transit.
 2. Bent arm shaft.
 3. Arm shaft thrust collar (at front of arm) set too tight.
 4. Bent needle bar.
 5. Tightness in needle bar vibrating bracket assembly or in bottom ball bushing assembly.
 6. Needle bar vibrating bracket hinge pin not correctly seated.
 7. Burr in needle bar driving arm ball pivot hole in bight amplitude pattern selector.
 8. Bent take-up lever.
 9. Thread take-up stud set too tightly.
 10. Misalignment of thread take-up lever link hinge stud.
 11. Insufficient thread clearance.
 12. Hook jammed with thread.
 13. Hook driving shaft collar set too close.
 14. Tightness of hook driving shaft.
 15. Insufficient clearance between hook driving shaft bushing (back) and gear.
 16. Hook shaft bushing is "floating", even though fastening screw may be tight.
 17. Gear meshes too tight. (See CAUTION at top of page 154.)
 18. Feed dog striking ends of throat plate slot or rubbing side of throat plate.
 19. Feed bar screw centers too tight.
 20. Feed lifting connecting rod bent.
 21. Feed lifting and feed rock shaft screw centers too tight.
 22. Feed fork bent.
 23. Insufficient clearance between arm and hand wheel bushing for heat expansion.
 24. Worm wheel on cam stack set too close to worm on arm shaft.
 25. Height of follower index pins not correctly set.
 26. Burrs or damage to bearing surfaces.
 27. Insufficient clearance between hand wheel and its recess in arm casting.
- NOTE:** See page 24 for hints on other causes of machine troubles, such as needle breakage and machine noise.

TO "RUN-IN" THE MACHINE

When a machine is completely assembled and adjusted, it should be checked for binding first. Lubricate the machine, as instructed on pages 126 and 127. Then "run-in" the machine with an electric motor, for from 5 to 10 minutes at medium speed or until all moving parts run smoothly when machine is turned

over by hand.

"Running-in" a machine should be done after every installation of an arm shaft, a hook driving shaft or a cam selector mechanism, and after every general repair.



WIRING DIAGRAM FOR MACHINES OF CLASS 401

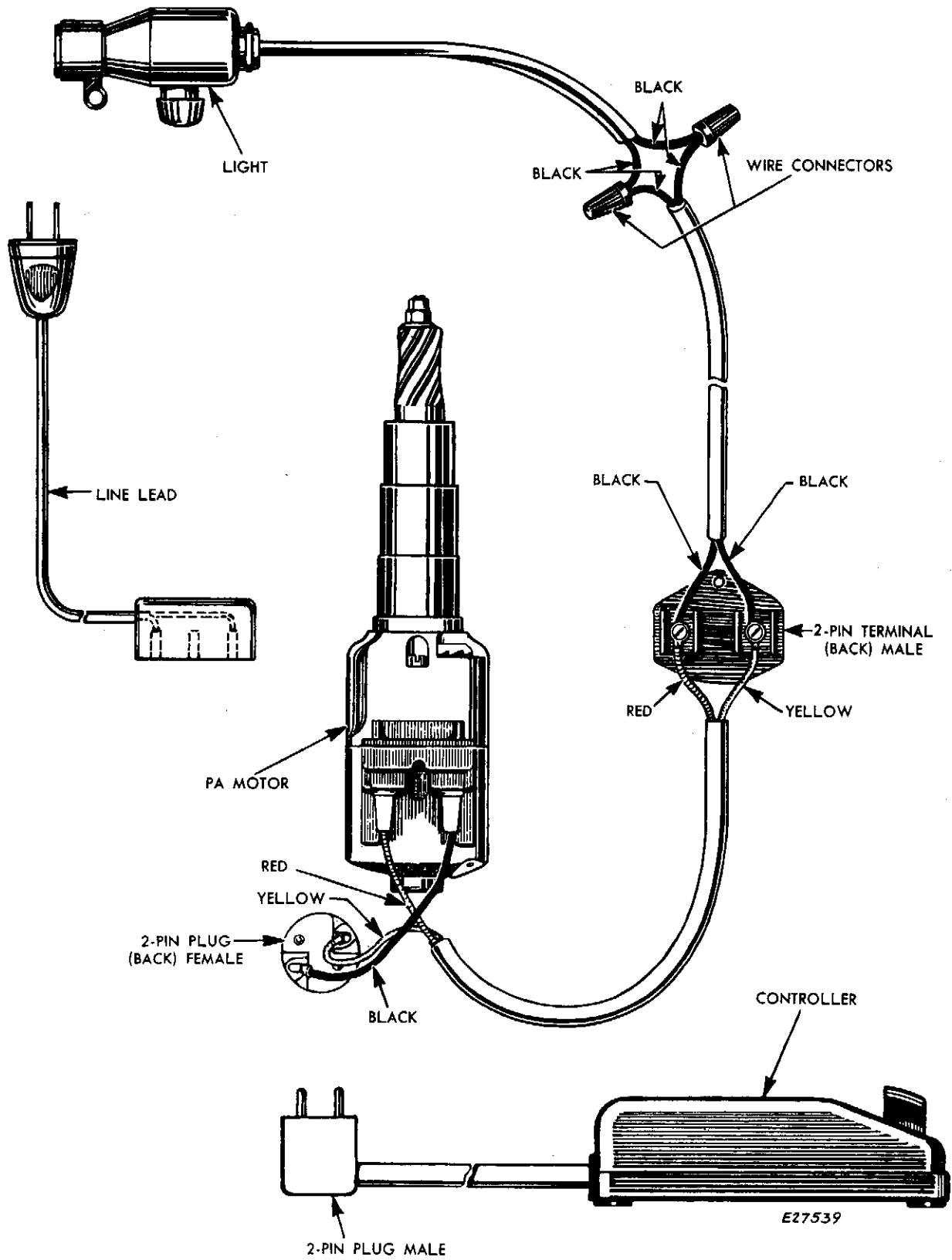

DESCRIPTION

Machine 306W24 (Automatic)

For straight, zigzag and ornamental stitching

Lockstitch

Foot power

Needle threaded from front to rear. Visible eye quickly threaded

Single or two-needle stitching

Improved One-Way Needle Clamp to insure correct needle setting. Thread guide welded on clamp to overcome interference with attachments

Automatic bobbin winder. Extra capacity bobbin

Reversible Clamp Washer for stop motion mechanism

Belt-driven rotary hook on horizontal axis rotates across line of feed (transverse hook) making two revolutions for each revolution of arm shaft

Location of hook shaft, at sewing hook end, controlled by front bushing

Numerically graduated bight regulator

Maximum width of zigzag stitch (bight)—approximately 3/16 inch (5mm.)

Straight stitching as well as zigzag stitching performed at Central Position of needle, at extreme Left Position of needle, at extreme Right Position of needle or at any point between these positions

Needle can swing a maximum of 3/16 inch toward right of extreme Left Position, a maximum of 3/16 inch toward left of extreme Right Position or a maximum of 3/32 inch on either side of Central Position

Needle bar frame return spring

Stitch designs automatically controlled by detachable FASHION disc. Six different discs furnished with machine. Each disc produces a specific style of Stitch

Reversible feed

Numerical graduations on stitch indicator plate show number of stitches per inch on left side of plate and distance between stitches, in millimeters, on right side of plate

Maximum length of stitch—6 to the inch. Length of stitch controlled in either direction by an Adjustable Stop Screw

Feed throw-out device for darning and embroidery

Link take-up

Numerically graduated tension device provided with central spacing disc for two needle threads

Needle bar stroke 1-9/64 inches

Presser bar lift 5/16 inch

Aluminum arm and bed

Bed 14-5/8 inches long—7 inches wide

Working space at right of needles 7-7/8 inches

Convenient handle concealed in arm top cover to facilitate lifting machine or lowering it into cabinet

Speed 1200 R.P.M.; according to material being sewn and type of work being done

When in operation, top of hand wheel should **always turn over toward operator**

This machine also made under designation of 306K24

Machine 306W25 (Automatic)

Same as Machine 306W24 except it is fitted with **BA3 Motor, SINGER Light and Disc Hand Wheel 105072 for moulded "V" Belt**

This machine also made under designation of 306K25

DESCRIPTION

Machine 306K22 (Non-Automatic)

(Treadle Machine)

For straight, zigzag and ornamental stitching

Lockstitch

Foot power

Disc Hand Wheel 125473

Needle threaded from front to rear. Visible eye quickly threaded

Single or two-needle stitching

Improved One-Way Needle Clamp to insure correct needle setting. Thread guide welded on clamp to overcome interference with attachments.

Automatic bobbin winder. Extra capacity bobbin

Reversible Clamp Washer for stop motion mechanism

Belt-driven rotary hook on horizontal axis rotates across line of feed (transverse hook) making two revolutions for each revolution of arm shaft

Location of hook shaft, at sewing hook end, controlled by front bushing

Numerically graduated bight regulator

Maximum width of zigzag stitch (bight—approximately 3/16 inch (5mm.)

Straight stitching as well as zigzag stitching performed at Central Position of needle at extreme Left Position of needle, at extreme Right Position of needle or at any point between these positions

Central Position of Needle is fixed by a groove in the tenon plate on the Bight Control Mechanism

Needle can swing a maximum of 3/16 inch toward right of extreme Left Position, a maximum of 3/16 inch toward left of extreme Right Position or a maximum of 3/32 inch on either side of Central Position

Reversible feed

Numerical graduations on stitch indicator plate show the number of stitches per inch on left side of plate and the distance between stitches in millimeters, on right side of plate

Maximum length of stitch—6 to the inch. Length of stitch controlled in either direction by Adjustable Stop Screw

Feed throw-out device for darning and embroidery

Link take-up

Numerically graduated tension device provided with central spacing disc for two needle threads

Needle bar stroke 1-9/64 inches

Presser bar lift 5/16 inch

Aluminum arm and bed

Bed 14-5/8 inches long—7 inches wide

Working space at right of needles 7-7/8 inches

Convenient handle concealed in arm top cover to facilitate lifting machine or lowering it into cabinet

Speed 1200 R.P.M.; according to material being sewn and type of work being done

When in operation top of hand wheel should **always turn over toward operator**

Machine 306K23 (Non-Automatic)

Same as Machine 306K22 except it is fitted with **BAK4 Motor, SINGER** Light and Disc Hand Wheel 105072.

DESCRIPTION

Machine 206K43 (Non-Automatic)

For straight, zigzag and ornamental stitching

Lockstitch

Electric power, belt driven

Fitted with BAK4 Motor and SINGER Light

Disc Hand Wheel 105072 for 3/16 inch moulded "V" belt

Needle threaded from front to rear. Visible eye quickly threaded

Single or two-needle stitching

One-Way needle clamp insures correct needle setting

Automatic bobbin winder. Extra capacity bobbin

Belt-driven rotary hook on horizontal axis rotates across line of feed (transverse hook), making two revolutions for each revolution of arm shaft

Location of hook shaft, at sewing hook end, controlled by front bushing

Numerically graduated bight regulator

Maximum width of zigzag stitch (bight)—approximately 3/16 inch (5mm.)

Straight Stitching as well as zigzag stitching performed at Central Position of needle, at extreme Left Position of needle, at extreme Right Position of needle or at any point between these positions.

Central Position of needles fixed by a groove in the tenon plate on Bight Control Mechanism

Needle can swing a maximum of 3/16 inch toward right of extreme Left Position, a maximum of 3/16 inch toward left of extreme Right Position or a maximum of 3/32 inch on either side of Central Position.

Reversible feed

Numerical graduations on stitch indicator plate show the number of stitches per inch on left side of plate and distance between stitches, in millimeters, on right side of plate

Maximum length of stitch—6 to the inch. Length of stitch controlled in either direction by an Adjustable Stop Screw

Feed throw-out device for darning and embroidery

Link take-up

Numerically graduated tension device

Needle bar stroke 1-9/64 inches

Presser bar lift 5/16 inch

Aluminum arm and bed

Bed 14-5/8 inches long—7 inches wide

Working space at right of needles, 7-3/4 inches

Speed 1200 R.P.M.; according to material being sewn and type of work being done

When in operation top of hand wheel should **always turn over toward operator**

DESCRIPTION

Machine 206K25 (Non-Automatic)

- For straight, zigzag and ornamental stitching
- Lockstitch
- Electric power, belt driven**
- Fitted with BAK4 Motor and SINGER Light Disc Hand Wheel 105072 for 3/16 inch moulded "V" belt**
- Needle threaded from front to rear. Visible eye quickly threaded
- Single or Two-needle stitching
- Automatic bobbin winder. Extra capacity bobbin
- Belt driven rotary hook on horizontal axis rotates across line of feed (transverse hook) making two revolutions for each revolution of arm shaft
- Location of hook shaft, at sewing hook end, controlled by front bushing
- Graduated bight regulator
- Maximum width of zigzag stitch (bight)—approximately 3/16 inch (5 mm.)
- Straight stitching as well as zigzag stitching performed at central position of needle, extreme Left Position of needle or any point between these positions**
- Needle can swing a maximum of 3/16 inch toward right of extreme Left Position or a maximum of 3/32 inch on either side of Central Position**
- Reversible feed
- Numerical graduations on stitch indicator plate show approximate distance between stitches in millimeters**
- Maximum length of stitch—6 to the inch. Length of stitch controlled in either direction by an Adjustable Stop Screw
- Stitch regulator lever fitted with thumb nut to lock lever at desired setting**
- Link take-up
- Graduated tension device—**no numerals**
- Needle bar stroke 1-9/64 inches
- Presser bar lift 5/16 inch
- Aluminum arm and bed
- Bed 14-5/8 inches long—7 inches wide
- Working space at right of needles 7-3/4 inches**
- Speed 1200 R.P.M.; according to material being sewn and type of work being done
- When in operation top of hand wheel should **always turn over toward operator**

DESCRIPTION

Machine 319w2 (Automatic)

For straight, zigzag and ornamental stitching

Lockstitch

Electric Power, belt driven, fitted with BA3 motor

SINGER Light provides perfect illumination

Needle threaded from front to rear. Visible eye quickly threaded

Single or two-needle stitching

Improved One-Way Needle Clamp to insure correct needle setting. Thread guide welded on clamp to overcome interference with attachments

Automatic bobbin winder. Extra capacity bobbin

Reversible Clamp Washer for stop motion mechanism

Belt-driven rotary hook on horizontal axis rotates across line of feed (transverse hook) making two revolutions for each revolution of arm shaft

Location of hook shaft, at sewing hook end, controlled by front bushing

Numerically graduated bight regulator

Maximum width of zigzag stitch (bight)—approximately $3/16$ inch (5mm.)

Straight stitching as well as zigzag stitching performed at Central Position of Needle, at extreme Left Position of needle, at extreme Right Position of needle or at any point between these positions

Needle can swing a maximum of $3/16$ inch toward right of extreme Left Position, a maximum of $3/16$ inch toward left of extreme Right Position or a maximum of $3/32$ inch on either side of Central Position

Needle bar frame return spring

Zigzag or ornamental stitching is accomplished automatically by means of cams, called FASHION Discs, which produce the particular design of each

FASHION Disc. A bank of five discs are permanently mounted inside the arm of the machine and a sixth interchangeable disc is located on the outside of the arm so that it can be replaced by any one of the twenty-four additional discs furnished with the machine. By raising one or more of the disc selector levers, which extend from the arm top cover, a particular design or combination of designs can be produced automatically.

Reversible feed

Numerical graduations on stitch indicator plate show number of stitches per inch on left side of plate and distance between stitches, in millimeters, on right side of plate.

Maximum length of stitch—6 to the inch. Length of stitch controlled in either direction by an Adjustable Stop Screw

Feed throw-out device for darning and embroidery

Link take-up

Numerically graduated tension device provided with central spacing disc for two needle threads

Needle bar stroke $1-9/64$ inches

Presser bar lift $5/16$ inch

Aluminum arm and bed

Bed $14-5/8$ inches long—7 inches wide

Working space at right of needles $7-7/8$ inches

Convenient handle concealed in arm top cover to facilitate lifting machine or lowering it into cabinet

Speed 1200 to 1300 R.P.M.; according to material being sewn and type of work being done

When in operation, top of hand wheel should **always turn over toward operator**

This machine also made under designation of 319K2 and 319M2

Machine 319w1 (Automatic)

Same as Machine 319w2 except for Foot Power.
Machine 319w1 also made under designation of 319K1 and 319M1.

Machine 319w3 (Automatic)

Same as Machine 319w2 except equipped with BA5-8 Motor, Wiring Harness complete with Bed Extension Plate and Safety Switch for use with School Sewing and Cutting Table Sets 417, 418 and 419. (See page 118).

DESCRIPTION

Machine 401A (Automatic)

- For straight, zigzag and ornamental stitching
- Lockstitch
- Electric power, **gear driven, with PA Motor enclosed in machine**
- SINGER Light, with built-in switch, provides perfect illumination
- Light shade and lens assembled to arm as **separate unit**
- Needle (15 x 1)** threaded from front to rear
- Single or two-needle stitching
- Needle bar and presser bar **inclined at 9°** from vertical for easy vision
- Hinged face plate facilitates oiling and adjusting of needle bar, presser bar and thread take-up. **Diagram on inside of face plate illustrates threading** of machine
- Hinged presser foot
- Two throat plates, one for zigzag and one for central straight stitching, are furnished with machine
- Throat plate position lever, on bed, locks throat plate in "down" or sewing position, raises throat plate sufficiently to permit darning or embroidery and raises throat plate still higher to unlock it for easy removal
- Reversible clamp washer for stop motion mechanism
- Automatic bobbin winder. Extra capacity bobbin. Bobbin winder tension and nylon spool pin on bed
- Gear driven, rotary hook on **vertical axis**, located in front of needle, makes two revolutions to each stitch
- Maximum width of zigzag stitch (bight) — approximately 3/16 inch (5mm.)
- Straight stitching as well as zigzag stitching performed at Central Position of needle, at extreme Left Position, at extreme Right Position or at any point between these positions
- Needle can swing a maximum of 3/16 inch toward right of extreme Left Position or toward left of extreme Right Position or a maximum of 3/32 inch on either side of Central Position
- Straight, Zigzag or Ornamental stitching is accomplished by setting one or two knobs and a lever for selection of a particular stitch. Machine is fitted with seven built-in cams and one removable "Special" cam. Special cams with different stitch designs can be purchased and used in place of the removable cam furnished with the machine
- Two cam selector knobs and a red (bight amplitude) lever are located on front of arm in direct view of operator. Red lever also controls position of needle during straight stitching. The outer knob controls a rear cam follower. The inner knob controls a front cam follower. Selection of the positions of these two knobs and the red lever makes possible particular designs and combinations of designs automatically
- Stitch pattern plate cover on top of arm holds two nylon spool pins on top side and a chart on under side illustrating many particular designs determined by given knob and lever settings
- Reversible feed
- Graduated stitch length indicator plate. Feed regulator adjustable for **finer** regulation of short stitch
- Maximum stitch length—6 to inch
- Link take-up
- Numerically graduated tension device provided with central spacing disc for two needle threads
- Needle bar stroke 1-9/64 inches
- Presser bar lift **.295** inch
- Aluminum arm and bed
- Bed 16-1/2 inches long—7 inches wide
- Working space at right of needles 7-3/16 inches
- Speed 1200 to 1300 R.P.M.; according to material being sewn and type of work being done
- When in operation, top of hand wheel should **always turn over toward operator**

INDEX

	Page		Page
Description of Machines	163-168	Installation, 206K25	101, 102
Instructions for 306 automatic	3	Installation, 319	112
Instructions for 306 and 206K43 non-automatic ..	81	Installation, 401	157-159
Instructions for 206K25	87	Reason for disassembly, 306 and 206K43	69
Instructions for 319	103	Reason for removal, 306 and 206K43	67
Instructions for 401	125	Reason for removal, 206K25	92, 95
Arm shaft connection belt		Reassembly, 306 and 206K43	70-72
Care	28	Reassembly, 206K25	100-102
Removal from automatic		Removal, automatic and non-automatic	67
306	25	Removal, 206K25	99
319	106	Summary of controls and varieties of stitching, 306 and 206K43	64-67
Removal from non-automatic	89	Summary of controls and varieties of stitching, 206K25	97-99
Replacement on automatic		Bight lever sub-assembly, automatic	71
306	26-28	Bight limit screws, 306 and 206K43	63
319	107	Bight mechanism, exploded view on automatic	68
Replacement on non-automatic	90	Bight mechanism, exploded view on non-automatic	85
Timing Feed	29	Bight mechanism, exploded view on 206K25	100
Arm shaft, removal and replacement	160	Bight stops, 401	140
Bearing sleeve sub-assembly	70	Binding in feed connection assembly	109, 136
Bench inspection, order of checking customer's machines	5	Binding of feed rock shaft connecting link	32, 136
Bight amplitude stops, setting	140	Binding or end play in hook shafts	38, 40, 136
Bight amplitude and pattern selector - removal and replacement	159	Binding or looseness in needle vibrating mechanism	48, 135
Bight		Bobbin cases (differences)	105
Stitching at various widths, 306 and 206K43	62	Bobbin case holder, oiling	76, 123
Stitching at various widths, 206K25	96	Bobbin case holders (differences)	105
Bight control, installation on automatic	73	Bobbin thread tension, adjustment	21
Bight control, installation on 206K25	101-102	Bobbin winder adjustment	79
Bight control lever	62-67	Bobbin winder, removal and replacement (401)	151
Bight control lever, 206K25	92-99	Breaking needles, prevention of	11, 24
Bight control mechanism		Cam selector arm shaft and followers, removal and replacement	158
Adjustment, automatic	58-61, 138-141	Cam selector arm stops	139
Adjustment, non-automatic (except 206K25)	84		
Adjustment, 206K25	91-95		
Disassembly of 306 and 206K43	68, 69 and 85		
Disassembly, 206K25	99, 100		
Installation, 306 and 206K43	73		

INDEX (Continued)

Page	Page
Cam stack, timing138, 139	End play or binding in feed lifting rock shaft136
Cam stack, removal and replacement158	End play or binding in feed rock shaft136
Central needle position (straight stitch) 306 and 206K43 64	End play or binding in hook driving shaft38, 136
Central needle position (straight stitch) 206K25 .. 97	End play or binding in hook shaft 40
Central needle position (zigzag stitch) 306 and 206K43 66	Side-shake or binding in needle bar135
401 (#3 Position)141	End play or binding in stitch regulator135
Central needle position (zigzag stitch) 206K25 98	End play or binding in upright arm shaft137
Centralizing needle in needle hole of throat plate (401)142	Fabric, needle and thread chart 10
Checking customer's machines at the bench 5	FASHION disc follower frame and needle bar pitman removal and replacement50, 51
Check list for serviceman in the home, sample 7	FASHION disc follower frame stud adjustment, automatic 49
Check spring, setting132, 133	FASHION disc follower frame (319) Adjustment115
Clamp stop motion, adjustment 78	Noisy119
Clamp stop motion, removal and replacement 78	FASHION Discs (319) Removal116
Non-reversible clamp washer, 206 90	To assemble stack117
Reversible clamp washer, 30627, 28	To replace stack117
Reversible clamp washer, 401150	To substitute116
Coordinating extreme left and right needle positions, 306 and 206K43 61	FASHION Disc Selectors (319) Removal113
Coordination of bight control settings, 306 and 206K4358-61	Replacement114
Coordination of bight control settings, 206K2591-95	Feed and presser foot tests for squareness 57
Counterbalance (401)150	Feed connection assembly (binding) 319109
Description of machines163-168	Feed dog adjustment in relation to throat plate slots (sidewise and lengthwise)32, 129, 130
Description of needles 11	Feed dog clearance above hook 31
Eccentric location on hook driving shaft30 and 39	Feed dog height adjustment 206, 306 30
End play or binding in arm cross shaft, automatic 49	319108
End play or binding in arm shaft49, 137	401129
End play or binding in feed bar130	Feed forked connection assembly, removal36, 155
	Feed forked connection, installation37, 155
	Feed lifting rock shaft removal and replacement153

INDEX (Continued)

	Page		Page
Feed regulator assembly, removal	34	Inspection at the bench	5
Feed regulator assembly, replacement	35, 151	Preparation of machine	126
Feed rock shaft connecting link		Inspection in the home, order of	6
Adjustment for zero stitch length	33	Installation of feed forked	
Adjustment to avoid binding	32	connection assembly	37, 155
Feed rock shaft, removal and replacement	153	Instructions on 206K25	87
Feed throw-out	58	Instructions on 306 automatic	3
Feed timing	29, 131	Instructions on 206K43 and 306	81
Fork connection, centralizing eccentric stud,		Instructions on 319	103
non-automatic (except 206K25)	84	Instructions on 401	125
Formation of lock stitch	13-15	Left needle position (straight stitch), 206K25	97
Gear location on hook driving shaft	30 and 39	Left needle position (straight stitch),	
Hand wheel, removal	25, 89, 150	206K43 and 306	64
Hand wheel, replacement	27, 90, 150	Left needle position (zigzag stitch), 206K25	97
Height of index pins	138	Left needle position (zigzag stitch),	
Height of needle bar setting with gauge	45	206K43 and 306	65
Height of needle bar setting without gauge	44, 133	Left, right and central needle positions,	
Height of presser bar	56, 128	coordination of	
Hints for adjusters and mechanics	23, 161	206K25	91-95
Hook and needle		306 and 206K43	59-61
relationship	9, 41, 43, 44, 143, 144	401	140
Hook driving shaft, removal and replacement		Length of stitch	33
206, 306	39	Light fixture (401), remove and replace	146
319	110	Limit screws (bight), 206K43 and 306	63
401	153	Location of needle in needle clamp	
Hook driving shaft, removal of end play		Automatic and non-automatic	12
or binding	38	206K25	88
Hook, setting of	41, 143, 144	Lock stitch formation	13-15
Hook shaft, removal of end play or binding	38	Lubrication	
Hook driving shaft, removal of end play		206, 306	74-77
or binding (401)	136	319	121-123
Hook timing	43, 143	401	126, 127
Sequence of adjustments to be verified before		Machine, "run-in"	79, 161
timing hook	43	Maximum bight, 206K25	96
Index pins, setting height	138	Maximum bight, 206K43 and 306	63
Indicator plate of bight control	70	Maximum zigzag stitch, 206K25	98

INDEX (Continued)

	Page		Page
Maximum zigzag stitch, 206K43 and 306	65	Needle breaking, prevention of	11, 24
Motor, CAUTION against lubrication	77	Needle description	11
Motor, cleaning bracket boss, 319	118	Needle, fabric and thread chart	10
Motor, remove and replace (401)	145	Needle location in clamp	12, 88
Needle adjustment, sidewise in relation to throat plate and presser foot	52, 142	Needle, ordering	11
Needle and hook point setting	41, 144	Needle pendulum setting, adjustment	52
Needle and hook timing	43, 143	Needle perforation tests, 206K25	91-95
Needle bar connecting link noisy, 319	120	Needle perforation tests, 306 and 206K43	58-59
Needle bar damage	41, 48	Needle position, correction in relation to straight-stitching throat plate	22, 134
Needle bar driving arm, centralizing	141	Needle position, sidewise adjustment	52, 142
Needle bar driving arm, removal and replacement	159	Needle and hook, relationship	9
Needle bar height indicator, adjustment 206, 306	42	Needles and threads	8
319	111	Needle sizes	10
Needle bar height, setting with gauge	45	Needle striking sewing hook or presser foot	24
Needle bar height, setting without gauge	44, 133	Needle swing	62, 96
Needle bar holder, removal	46	Needle thread take-up and feed timing	29
Needle bar holder, replacement	47	Needle thread take-up (Check) spring, setting	132
Needle bar pitman and FASHION disc follower frame, removal and replacement	50, 51	Needle thread take-up, removal and replacement	157
Needle bar, radial alignment	44, 45, 133	Needle thread tension	18-20
Needle bar, removal and replacement	46, 47, 156	Needle thread tension, regulation	18, 132, 133
Needle bar setting with gauge	45	Needle thread tension, removal and disassembly	18, 148, 149
Needle bar setting without gauge	44, 133	Needle vibrator fork connection (removal and replacement) non-automatic	82
Needle bar, timing pendulum movement with gauge (automatic)	55	Needle vibrating mechanism, check for looseness or binding	48, 135
Needle bar, timing pendulum movement without gauge (automatic)	53, 54	Needle vibration, eliminating with gauge on automatic	60
Needle bar, timing pendulum movement without gauge (non-automatic)	83	Needle vibration, eliminating with gauge on non-automatic	84
Needle bar vibrating bracket removal and replacement	156, 157	Oiling bobbin case holder	76

INDEX (Continued)

	Page		Page
Oiling machine		Removal of feed regulator assembly	34, 151
206, 306	74-77	Replacement of cam stack, 401	158
319	121-123	Replacement of discs, 319	117
401	126, 127	Replacement of feed regulator assembly	35, 151
Order of inspection of customer's machines		Right needle position (straight stitch),	
at the bench	5	306 and 206K43	64
Order of inspection in the home	6	Right needle position (zigzag stitch),	
Ordering needles for swing-needle machines	11	306 and 206K43	65
Over-lubrication, dangers of		"Run-in" machine	77, 161
206, 306	76	Sample check list for serviceman in the home	7
319	123	Setting hook	41, 144
Pendulum setting of needle	52	Setting needle, 206K25	88
Pendulum timing of needle bar		Setting needle 306 and 206K43	12
with gauge on automatic	55	Setting needle bar height with gauge	45
Pendulum timing of needle bar		Setting needle bar height without gauge	44, 133
without gauge on automatic	53, 54	Setting up machine	4
Pendulum timing of needle bar		Sewing difficulties, causes and remedies	17
without gauge on non-automatic	83	Side-shake or binding in needle bar	135
Perfect lock stitch	15	Stitch formation	13-15
Pitman and frame (removal and		Stitch indicator plate	33
replacement)	50, 51	Stitching at various widths of bight and	
Pitman fulcrum eccentric stud, centralizing	60	positions of the needle	62, 96
Position finger, adjustment for thread clearance	42	Stitch length, regulating	33
Position lever settings, 206K25	97-99	Stitch regulator handle, removal	34
Position lever settings, 306 and 206K43	64-67	Stitch regulator handle, replacement	35
Presser bar height	56	Stop motion, adjustment	78
Preparation of machine for inspection	126	Stop motion, removal and replacement	78
Presser bar, removal and replacement	156	Non-reversible clamp washer, 206	90
Presser foot alignment to feed	57, 128	Reversible clamp washer,	
Presser foot and needle relation	52	306	27, 78
Presser foot height	128	401	150
Presser foot, regulating pressure of	56	Suggestions to the serviceman in the home	6
Removal of discs 319	116	Summary of bight controls on automatic	62-63

INDEX (Continued)

	Page		Page
Summary of bight controls on 206K25	96	Timing pendulum movement of needle bar without gauge, automatic	53, 54
Take-up in relation to feed timing	29	Timing pendulum movement of needle bar without gauge, non-automatic	83
Tension conditions	16	Tips on setting up machine	4
Tension on bobbin thread	21	Twin needle alignment	44, 45
Tension on needle thread	18, 132, 133	Twin needles, description of	11
Tests for squareness of presser foot to feed	57	Twist of thread	10
Thread clearance between position finger and bobbin case base		Upright arm shaft	145
206, 306	42	Varieties of stitching and summary of bight controls, 206K25	97-99
319	111	Varieties of stitching and summary of bight controls, 306 and 206K43	64-67
Thread clearance, Machine 401	131	Winding bobbins evenly	79
Thread, needle and fabric chart	10	Wiring diagram (401)	162
Threads and needles	8	Wiring harness, 319W3	118
Thread take-up (Check) spring, stroke of	19, 132	Wiring harness 401, remove and replace	147
Thread take-up (Check) spring, tension of	20, 132	Zero bight, 206K25	92-94, 96-98
Thread twist	10	Zero bight, 306 and 206K43	62
Throat plate position bracket	152	Zeroing out machine	140
Timing cam stack	138, 139	Zigzag stitching, 206K25	92-94, 96-98
Timing feed	29, 131	Zigzag stitching, 306 and 206K43	65-67
Timing hook in relation to needle	43, 143		
Timing pendulum movement of needle bar with gauge, automatic	55		