

Form K5959

This Book should be carefully  
preserved for reference.

INSTRUCTIONS  
FOR USING AND ADJUSTING  
**SINGER\***  
**B.A.K. ELECTRIC MOTORS**  
WITH FOOT CONTROL FOR  
FAMILY SEWING MACHINES

When requiring  
Needles, Oil,  
Parts or Repairs,  
for your Machine



Look for the  
Red "S"  
There are SINGER  
SEWING CENTRES  
in every City

THE SINGER MANUFACTURING CO.

All Rights Reserved

Printed in Great Britain

To all whom it may concern :

The improper placing or renewal of the trademark "SINGER" or any other of the trademarks of The Singer Manufacturing Company (all of which are duly Registered Trademarks) on any machine that has been repaired, rebuilt, reconditioned or altered in any way whatsoever outside a SINGER factory or an authorised SINGER agency is forbidden.

# Wiring Diagram of B.A.K. Motor and Light

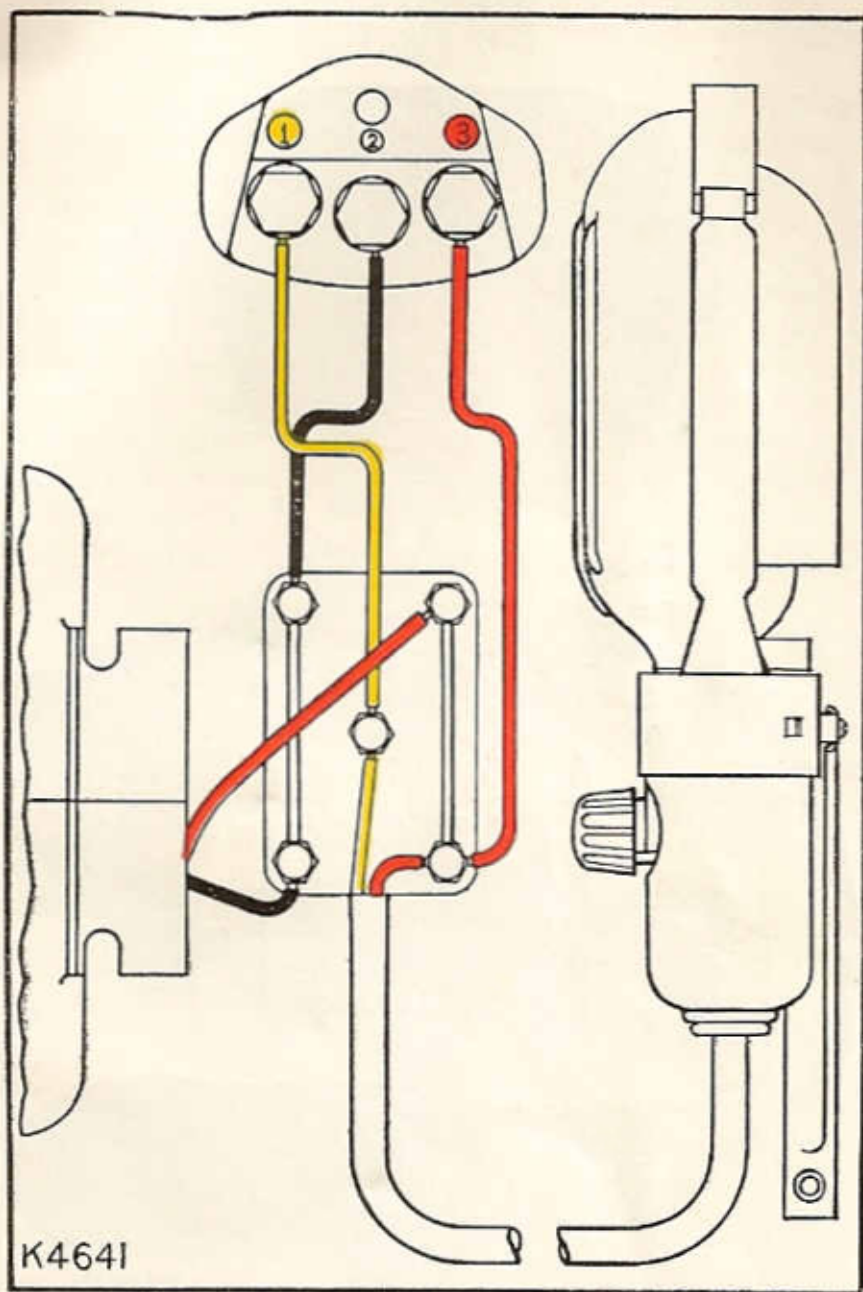

K4641

\* A Trademark of THE SINGER MANUFACTURING CO.

Form K5959  
(959)

To Attach the Light Cord to the Motor  
(See Fig. 1).

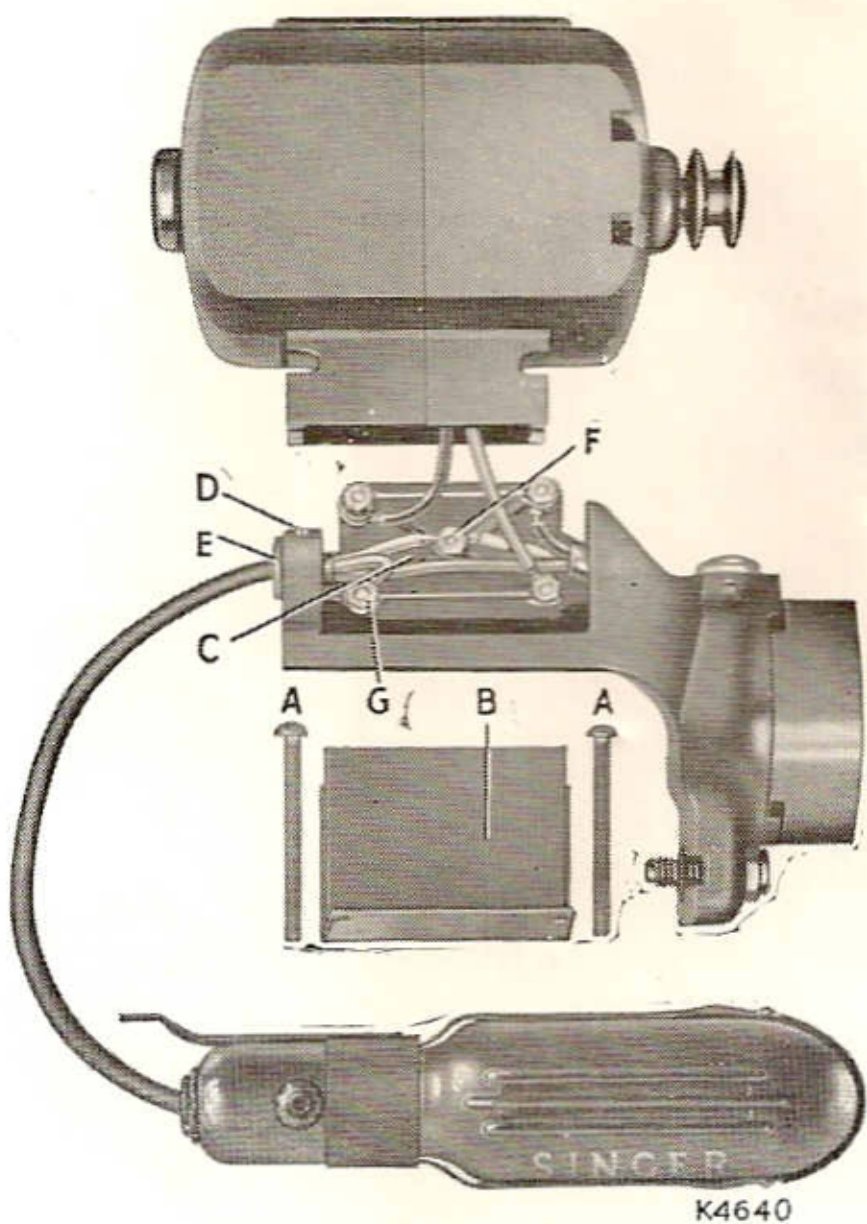

Fig. 1.

If a Light is to be fitted it must first be connected to the motor terminal plate C before the motor is attached to the machine.

Remove the two screws A and the plate B, loosen screw D, pull out the rubber plug from the hole E and insert Light cord with bushing, as illustrated. Remove the nuts from the centre terminal F and the lower left terminal G and place the eyelet of the yellow cord on terminal F and the eyelet of the red cord on terminal G, then replace the nuts.

Insert plate C into its receptacle below the motor, replace plate B, insert screws A and securely fasten. Tighten screw D so that it binds the bushing and Light cord.

To attach Light to machine, see pages 14 and 15.

### To Attach the Motor

The motor is attached to the machine arm, as shown in Fig. 3. Remove the japan from the edges of the bracket seat (H, Fig. 2) to allow the bracket to slide up and down freely when adjusting the tension of the motor belt.

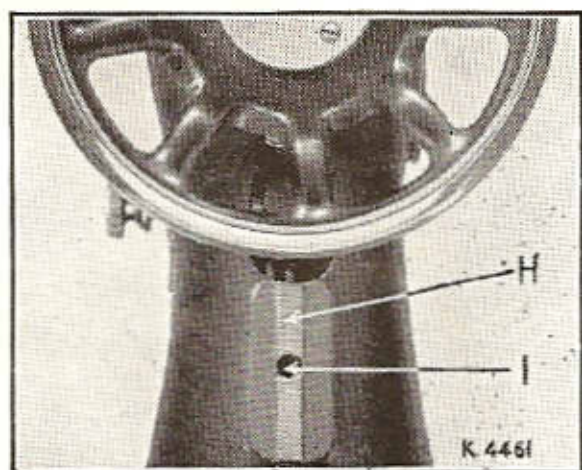

Fig. 2.

Place the motor bracket on the bracket seat, as shown in Fig. 3, and insert the hexagon head screw (K, Fig. 3) through the slot in the motor bracket and into the screw hole (I, Fig. 2) after making sure that the steel washer is on the screw. Slide the bracket, with the motor, upward as far as possible, then tighten the screw.

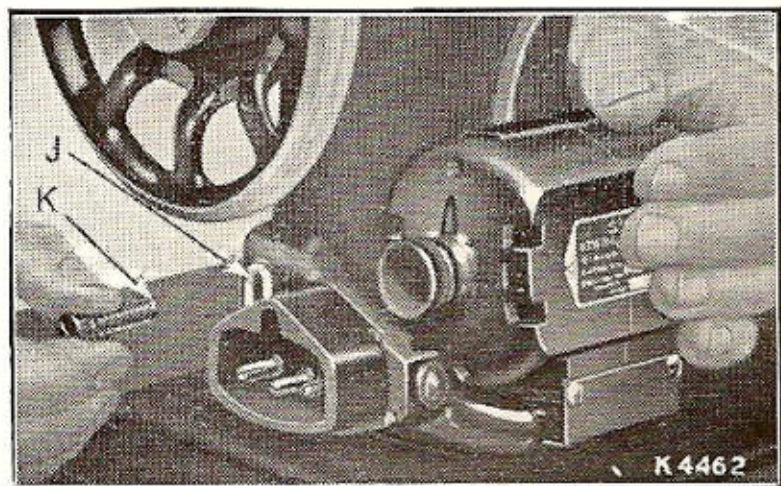

Fig. 3. Placing the Motor in Position.

### Putting on Belt.

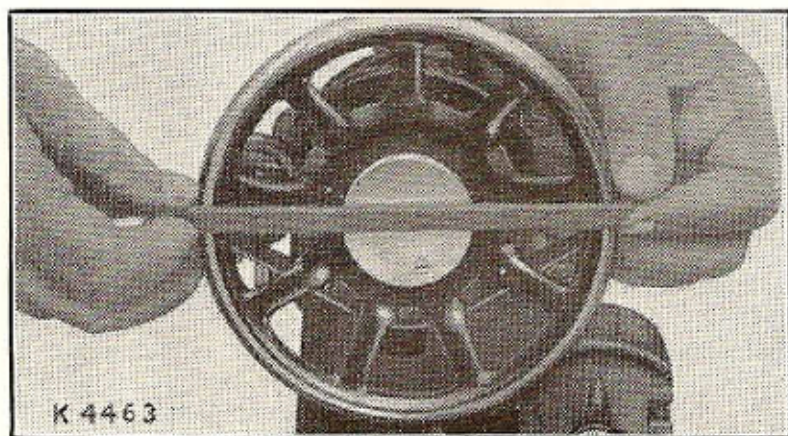

Fig. 4. Putting on Belt.

Apply the motor belt from the bottom of the hand wheel and bring it over the top of the wheel, as shown in Fig. 4. Place the belt in the groove of the hand wheel and in the groove of the motor pulley.

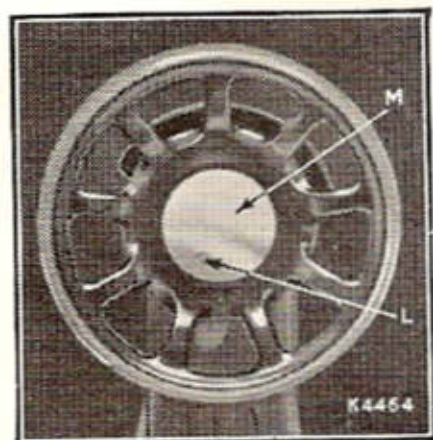

Fig. 5.

side. The correct position of the clamp washer is against the hand wheel hub **with the inner prongs in the slots of the bushing, but projecting outward** to make contact with the clamp screw. When the washer is incorrectly inserted, with the two inner prongs projecting toward the bushing, the clamp stop motion will not release the sewing mechanism. Place the motor belt in the groove of the hand wheel and in the groove of the motor

Where the belt is too small to go over the hand wheel it is necessary to remove the latter. To do so, loosen the small screw (L, Fig. 5) which holds the stop motion clamp screw (M, Fig. 5) in place, and take off the clamp screw, as shown in Fig. 6. Examine the position of the clamp washer (N, Fig. 6). The two inner prongs are not flat but bent outward on one

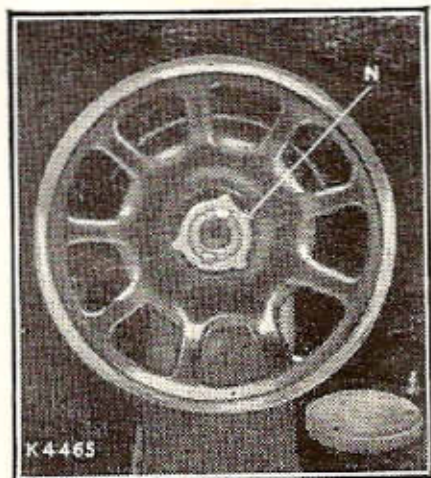

Fig. 6.

pulley, replace the hand wheel and the washer (N, Fig. 6) as described, insert the clamp screw (M, Fig. 5) and tighten the small screw (L, Fig. 5). Sometimes it is necessary to change the position of the washer by giving it a half turn before replacing the clamp screw.

### To Adjust the Belt Tension

Loosen the screw (K, Fig. 7) to allow the motor to drop downward. Now retighten the screw, and the belt will be found to have the correct tension.

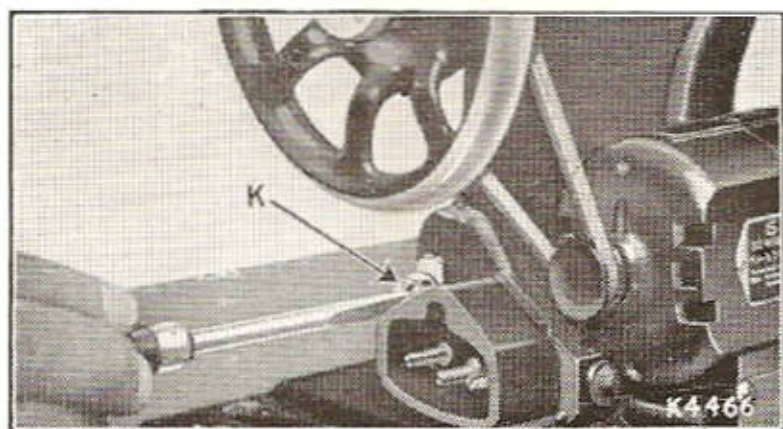

Fig. 7. Regulating the Belt Tension.



**Foot Controller.**

Fig. 8.

The foot controller should be placed on the floor in a convenient position for the user's right foot.

The supply lead and the cord for the foot controller are attached to the socket plug, as shown in Fig. 8.

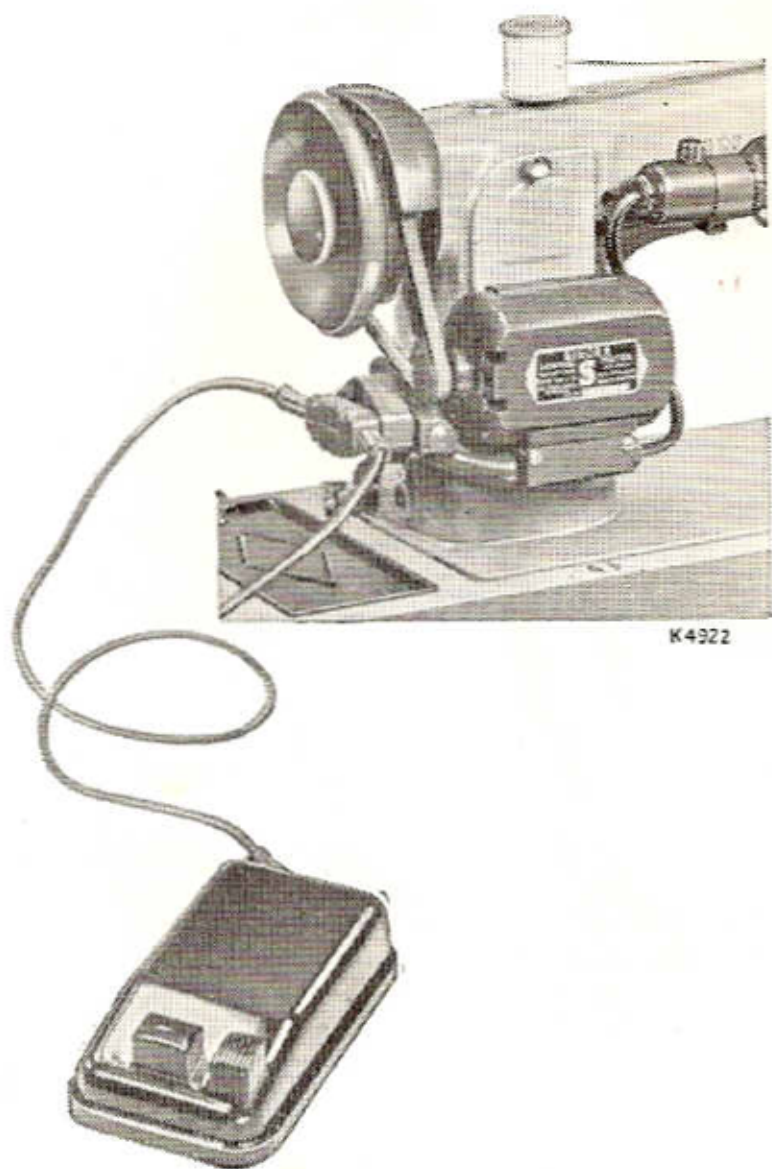
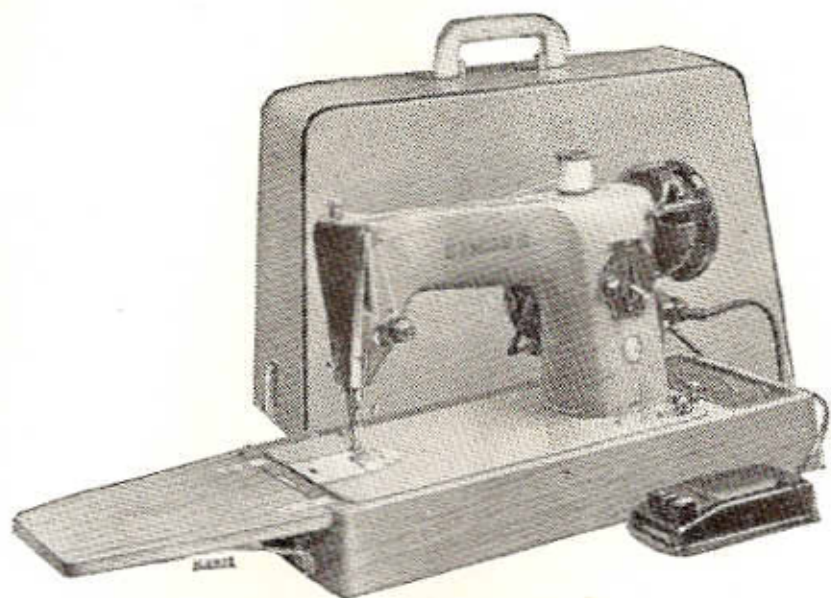

Fig. 9. Portable Machine with Foot Controller.

### Speed

Place the right foot on the rest at the right of the controller and turn foot inwards to depress the pedal. This will set the machine in motion, the hand wheel turning in the right direction, and the speed being perfectly controlled by the amount of pressure **which should be applied gradually.**

Speeds vary from bare movement up to 1000 stitches per minute, as required by the work in hand. **Immediately pressure is withdrawn, the machine will stop. Do not attempt to stop the machine by placing your hand on the hand wheel, as this is likely to cause injury to the controller or motor.**

### Embroidery and Darning

For embroidery and darning operate the machine at a low speed. Light pressure of the foot on the pedal will give a speed suitable for handling materials being darned or embroidered.

**Caution**—When you have finished your sewing always disconnect the plug from the electric point.

## Examination and Replacement of Brushes (See Figs. 10 and 11).

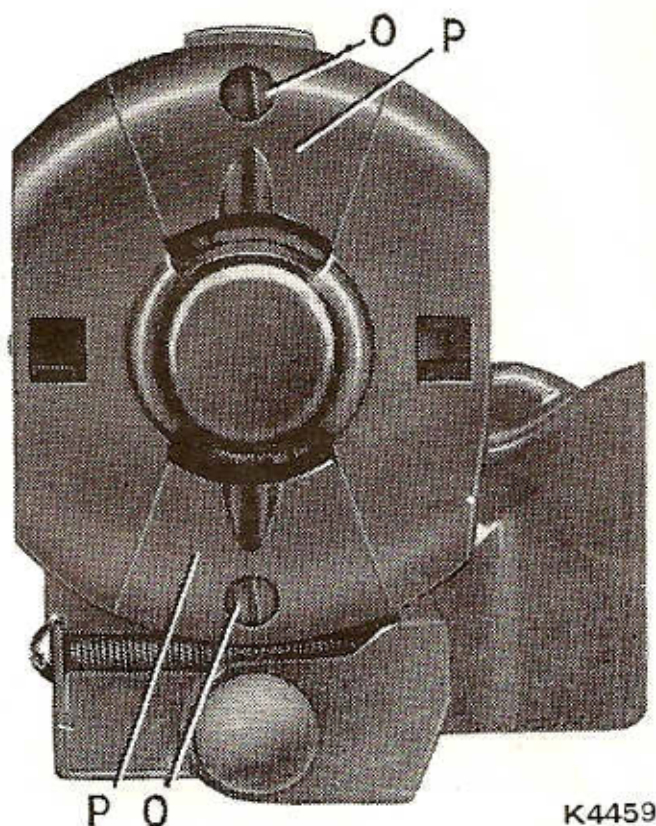

Fig. 10

If, after long usage, the motor ceases to function, the brushes may have become worn. To ascertain if this be the case, disconnect the current from the motor by removing the plug from the three-pin terminal. Take out the two screws (O), remove the covers (P) and lift out the brush tubes (Q) with springs (R) and brushes (S).

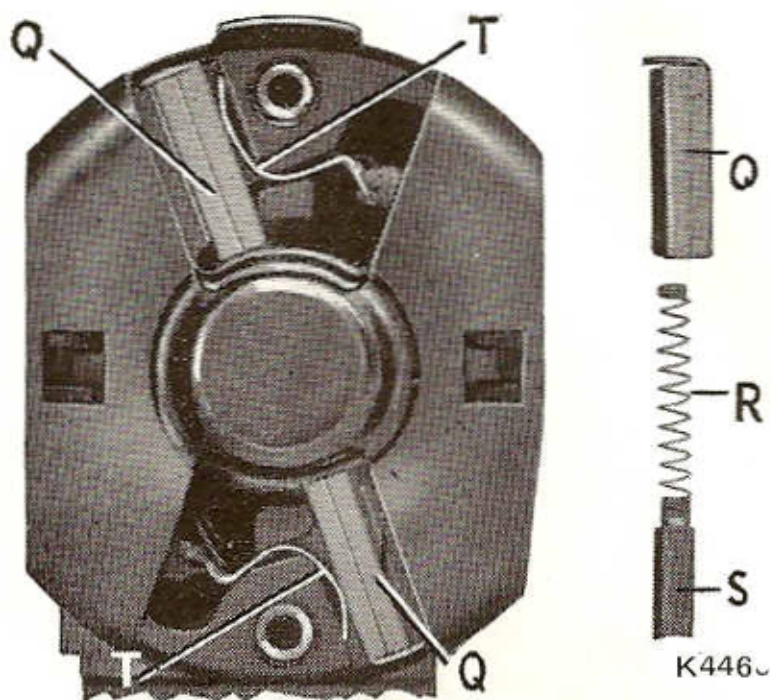

Fig. 11

Unless the machine is worked continuously, the brushes, which are of the best grade procurable, should last for several years, but it is well to examine them every twelve months to make sure that they are not wearing excessively. Before replacing the brush tubes (Q) take care that the brushes (S) are in the position they occupied before removal, with the concave end in the position shown in Fig. 11. When inserting the brush tubes make sure that they are in contact with the spring (T).

## The Light.

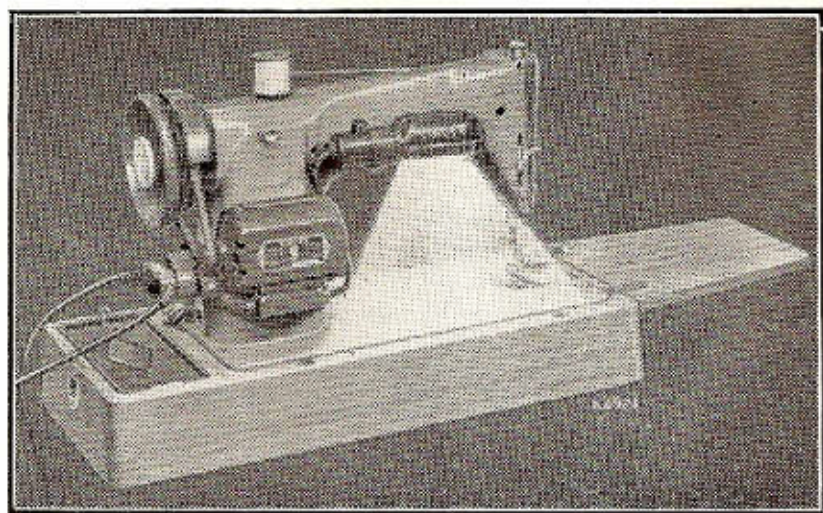

Fig. 12.

This improved light should be fitted to all SINGER Sewing Machines where electric current is available.

Its light is thrown just where needed, thus enabling the operator to see the stitching more clearly. It prevents eye strain and fatigue, and the quality of the work performed by its aid is therefore much improved. It also saves time and annoyance when threading the needle—in fact, its many advantages are worth far more than its cost.

## To Turn Light "on" or "off"

To turn light on reach over machine arm and turn switch B, Fig. 13 to right. To extinguish, turn switch to left.

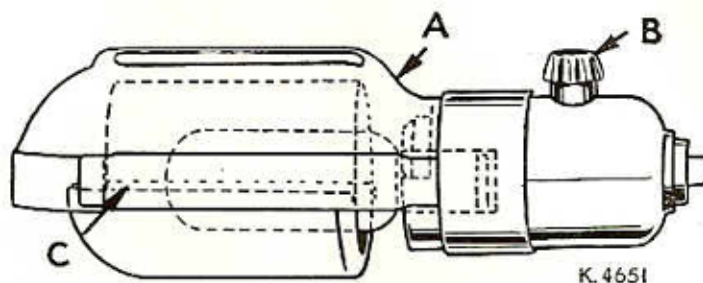

Fig. 13. Light.

## To Remove the Bulb

Grasp light socket so that thumb extends over switch B. Then press shade with thumb at A to release shade from two catches and slide it halfway out of shade holder C. Then press bulb into socket and at same time turn bulb over from machine as far as it will go to unlock pin D (see Figs. 14 and 16). Withdraw the bulb.

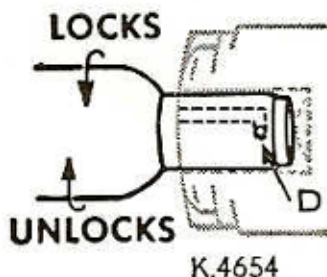

Fig. 14. Locking or  
Unlocking Bulb Pins.

## To Insert a New Bulb

Press bulb into socket and turn it over toward machine until pin D enters notch in socket (see Figs. 14 and 16). Return shade to its normal position as shown in Fig. 13.

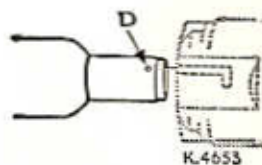

Fig. 15. Inserting Bulb in Socket.

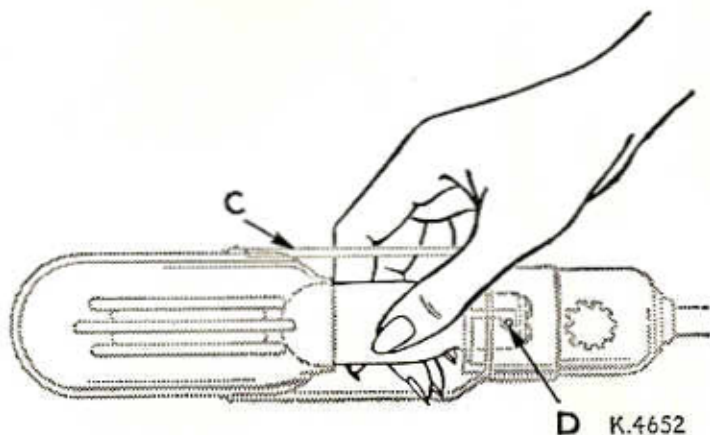

Fig. 16. Removing and Replacing the Bulb.

To Attach the Light.  
15K and 201K Machines.

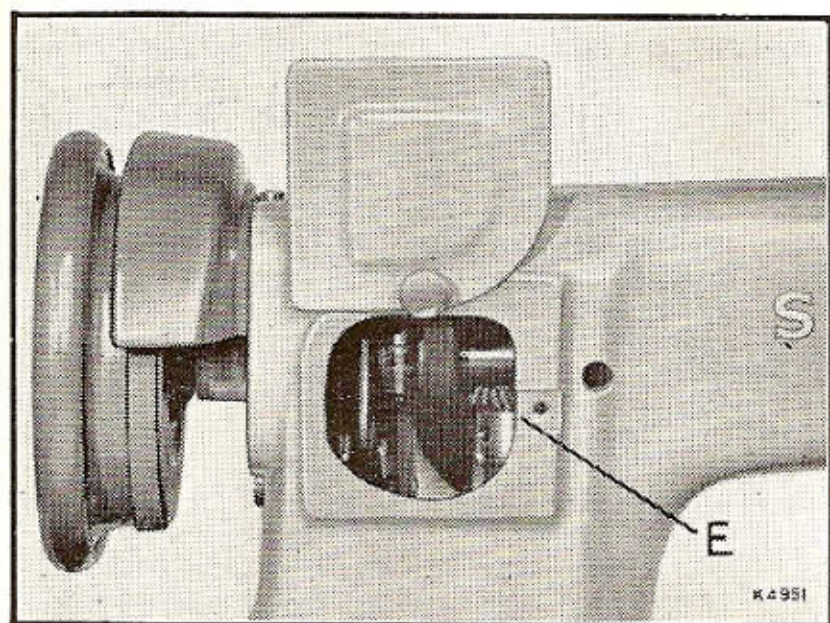

Fig. 17.

The complete light should be screwed to the machine by placing its bracket in the slot E, Fig. 17, and tightening the screw.



To Attach the Light.  
99K and 185K Machines.

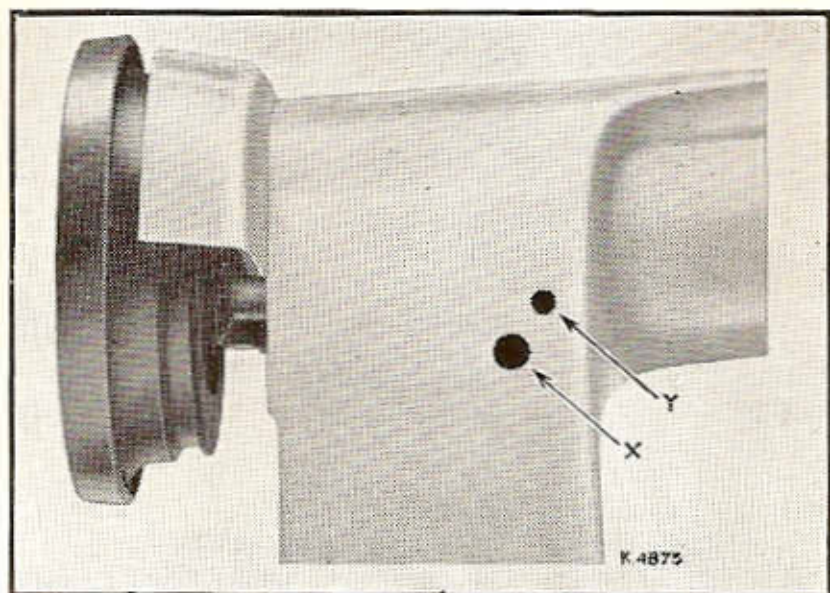

Fig. 18.

The complete light should be screwed to the machine by placing the dimple in the bracket in the hole X, Fig. 18 and tightening the screw in the hole Y.

**THE IMPORTANCE OF USING  
SINGER NEEDLES FOR YOUR  
SEWING MACHINE**

---

You will obtain the best stitching results from your sewing machine if it is fitted with a SINGER Needle.

---

SINGER Needles can be purchased only from SINGER SEWING CENTRES or SINGER Salesmen.

---

SINGER Needles are stamped with the Trademark SINGER or SIMANCO\* and are contained in Green Packets which bear the famous red letter "S."

---

Needles in Containers marked "For Singer Machines" are not SINGER made needles.

