

SINGER

15K80,K82

ILLUSTRATED
LIST OF PARTS

FOR

Nos. 15K80 to 15K82
Machines



**A Trade Mark of
THE SINGER MANUFACTURING COMPANY

2835

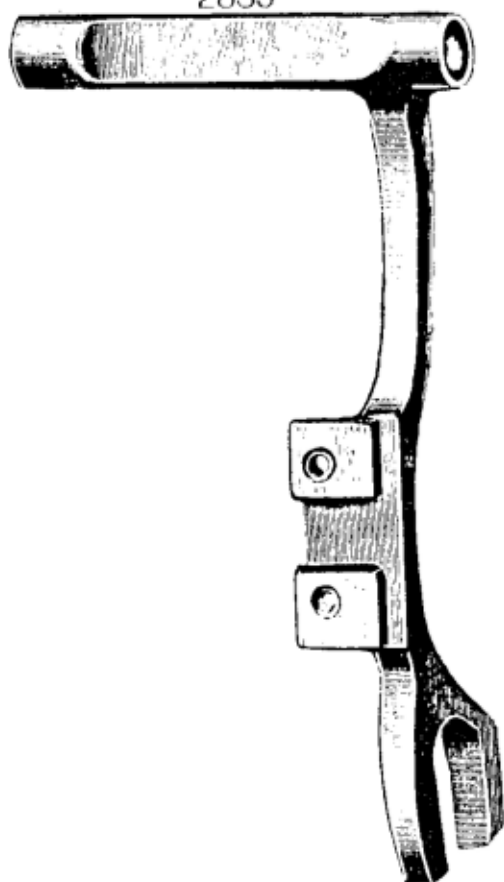

121170

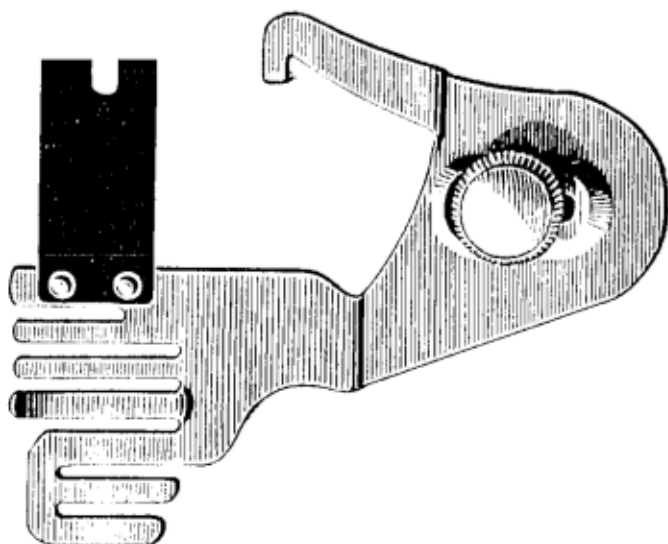

121547

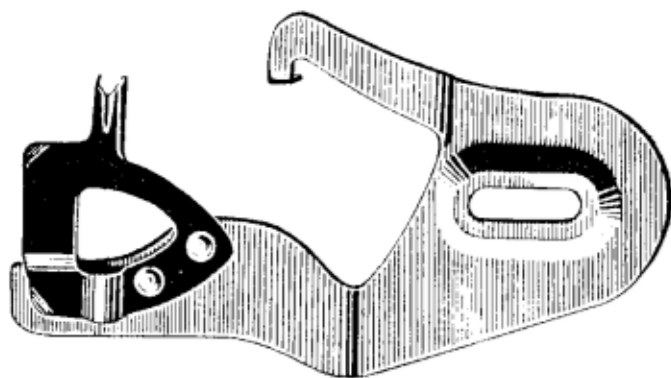

86496



86493



86494



86495



36583

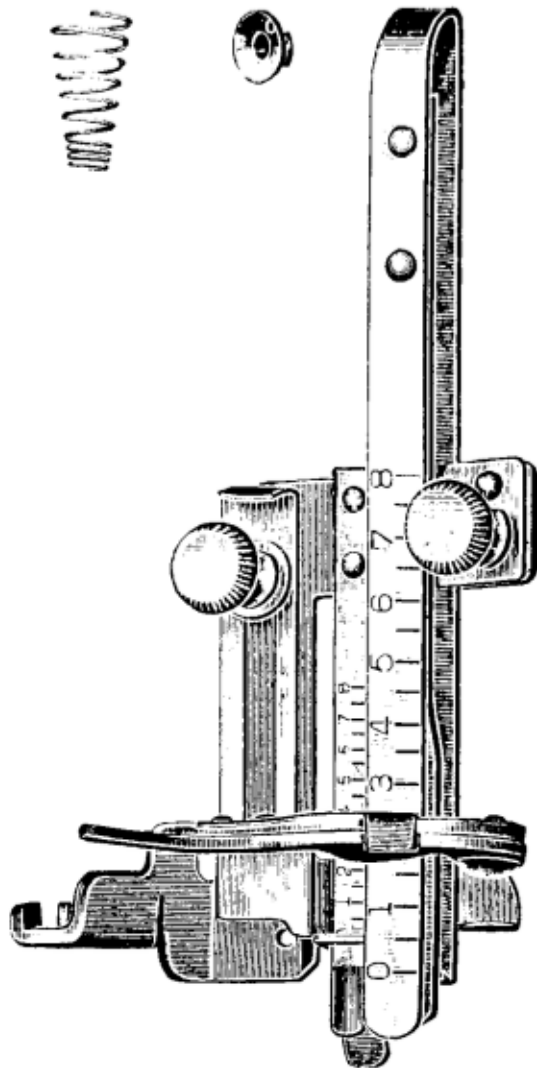

140545



87589

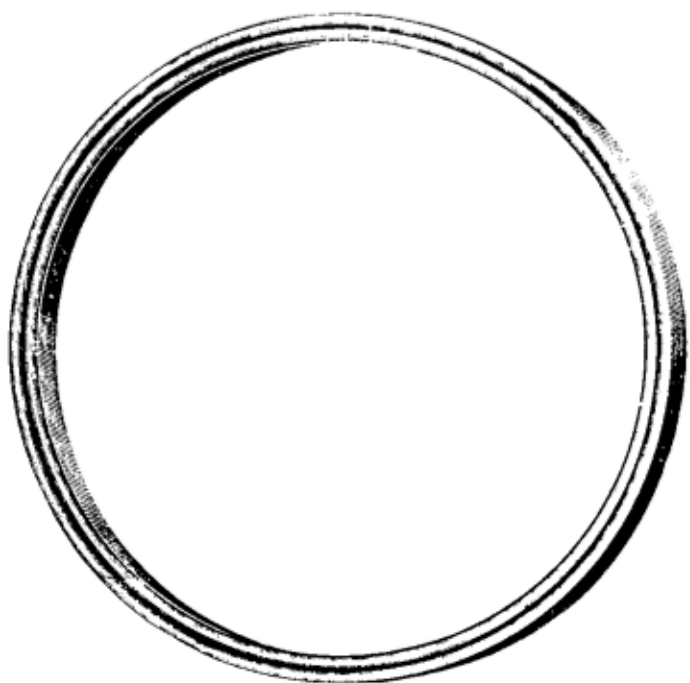

96422

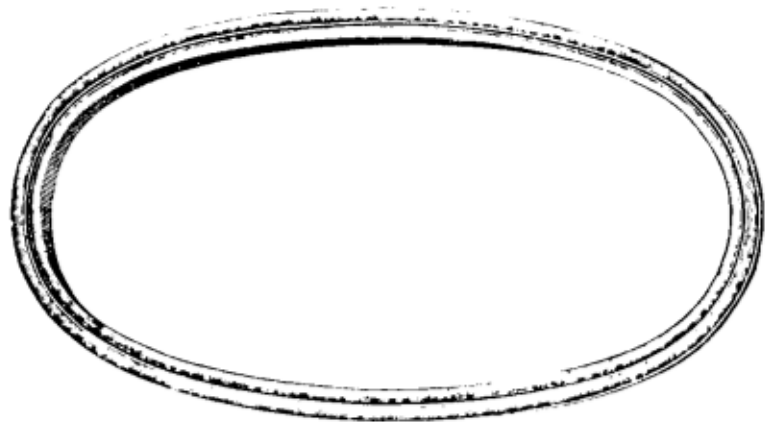

15406

50291

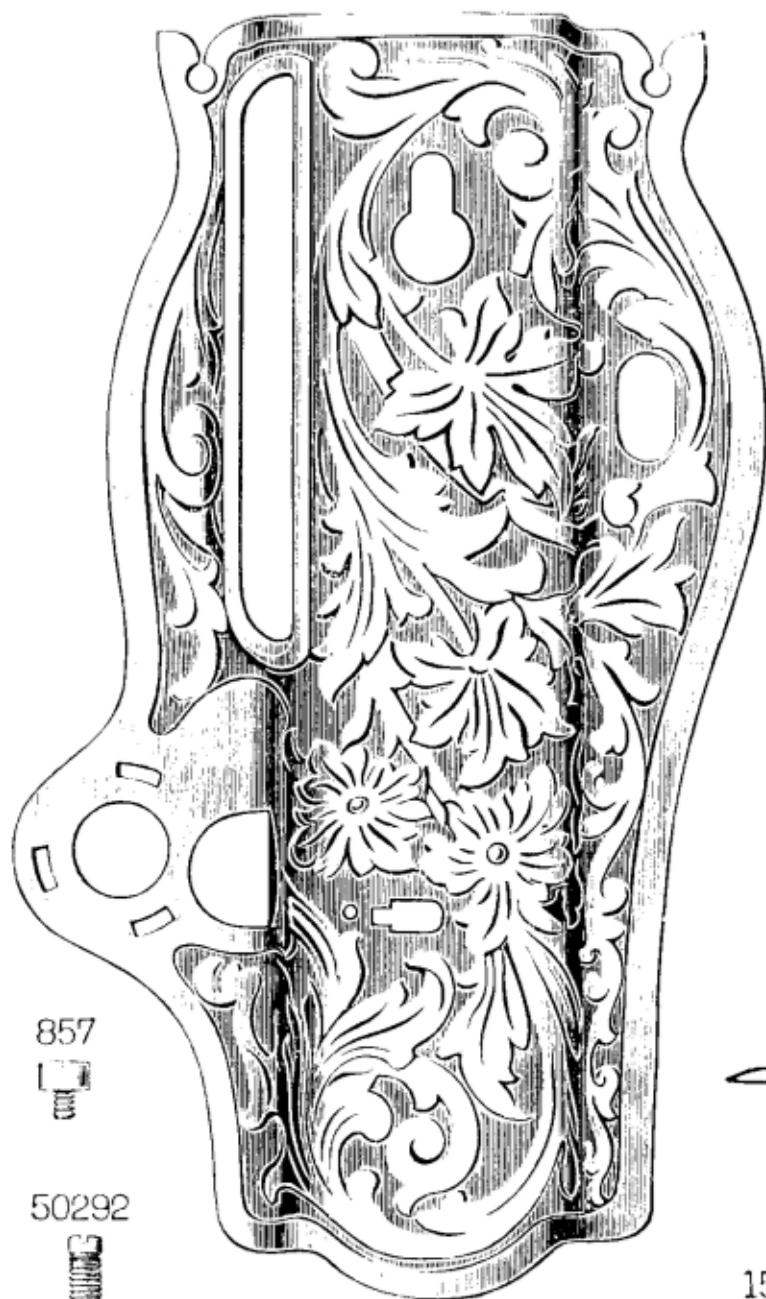

15410



55645



857



50292



15412



13710



15428

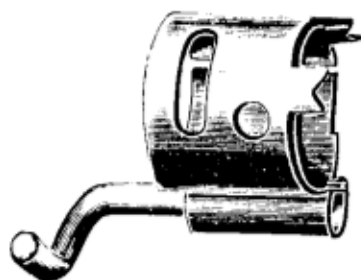

32672

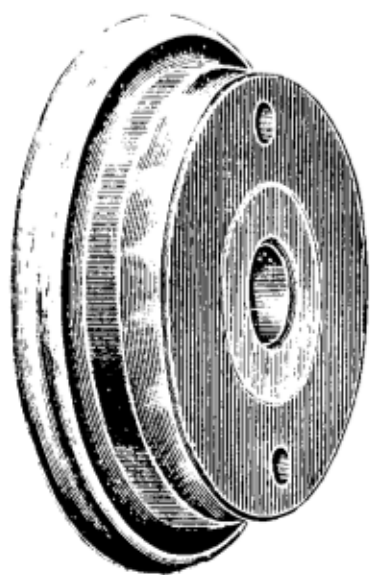

125061

125079

125045

125039

125055

125038

125041

125050

125052

125036

15170

125060

125047

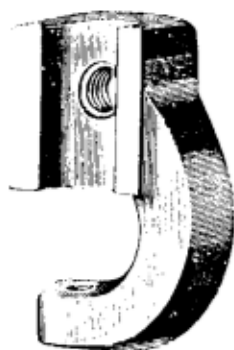
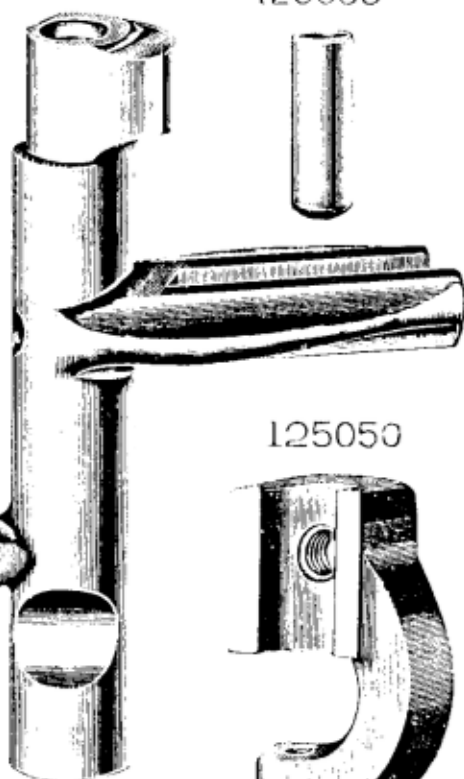
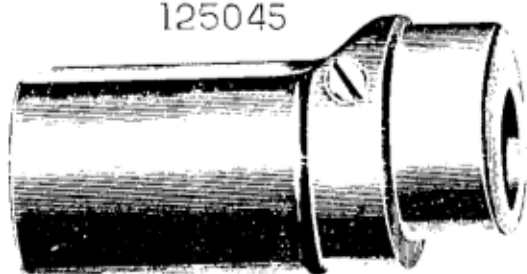

125059



125064

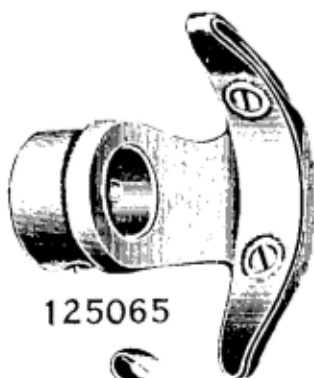

51228

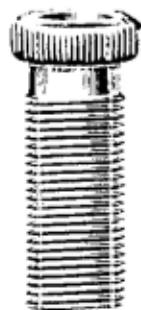

125065



125048



125049



66752



SS528



1498



51225



51229



51246



193



50053



51045



51224



896



WV95



125327

125068

15288

125324

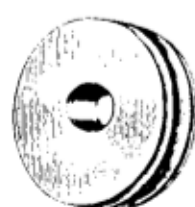

7071



15287

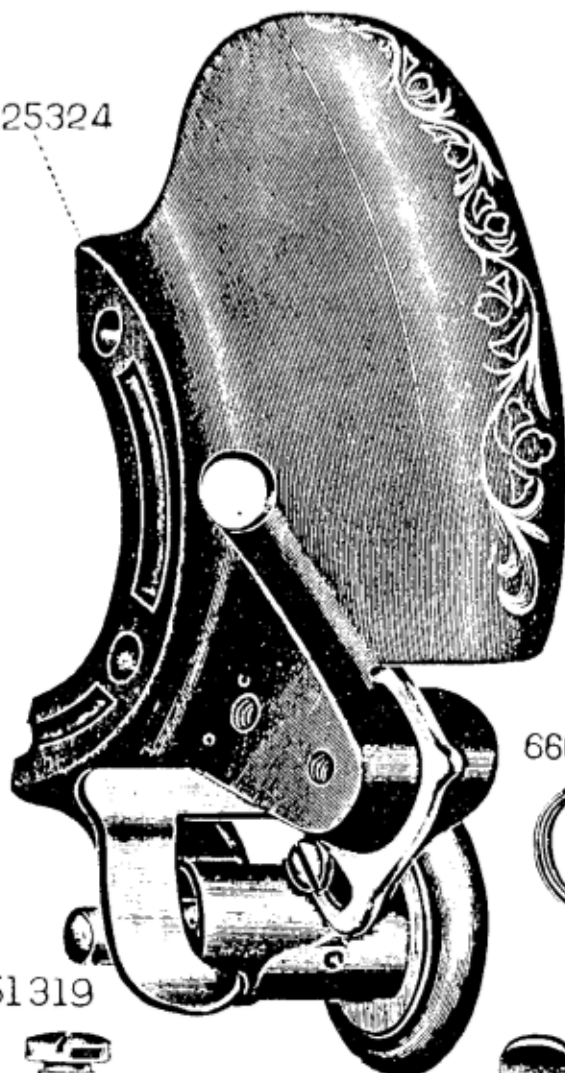

66601

125462

45847



125326

51319



140138



66670



125376



125395

51303



45846



45845

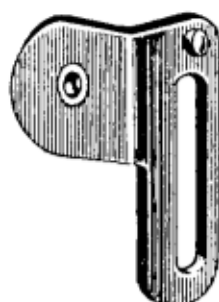
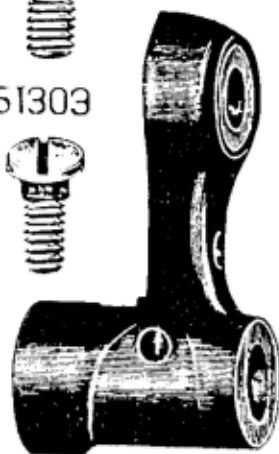

94028



94048



94046



94036

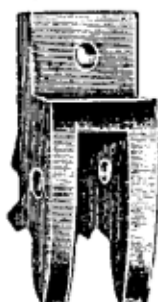

94039

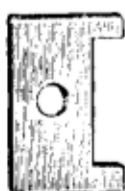

94029



94069



80028



94032



94044



55531



94038



94037



94033



94030



183



94040



SS599



SS600



SS566



399



SS565



SS567



94050

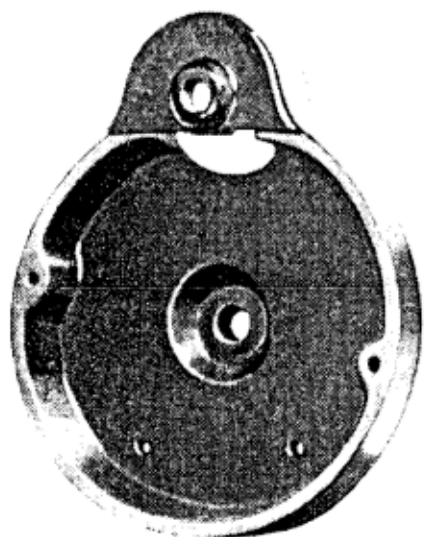

94031



94051

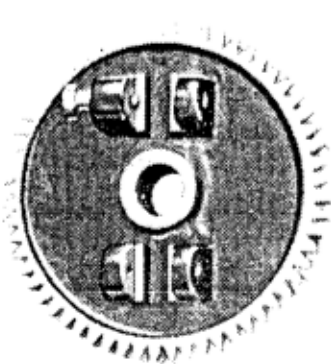

94027



94052

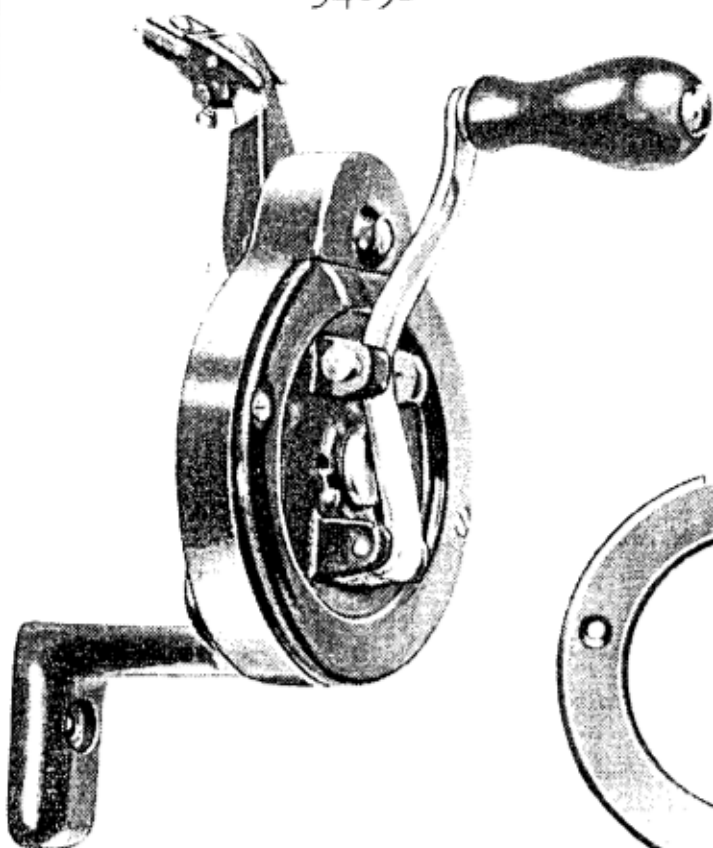

94016

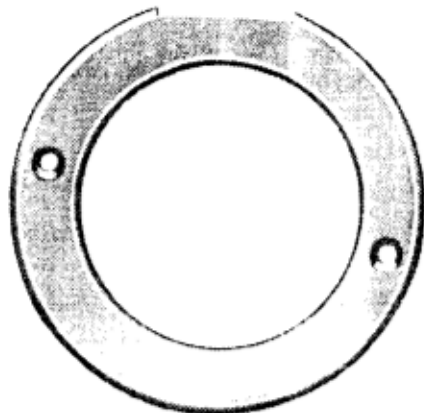

SS 528



96425



96426



96844



96427



96845



NW95



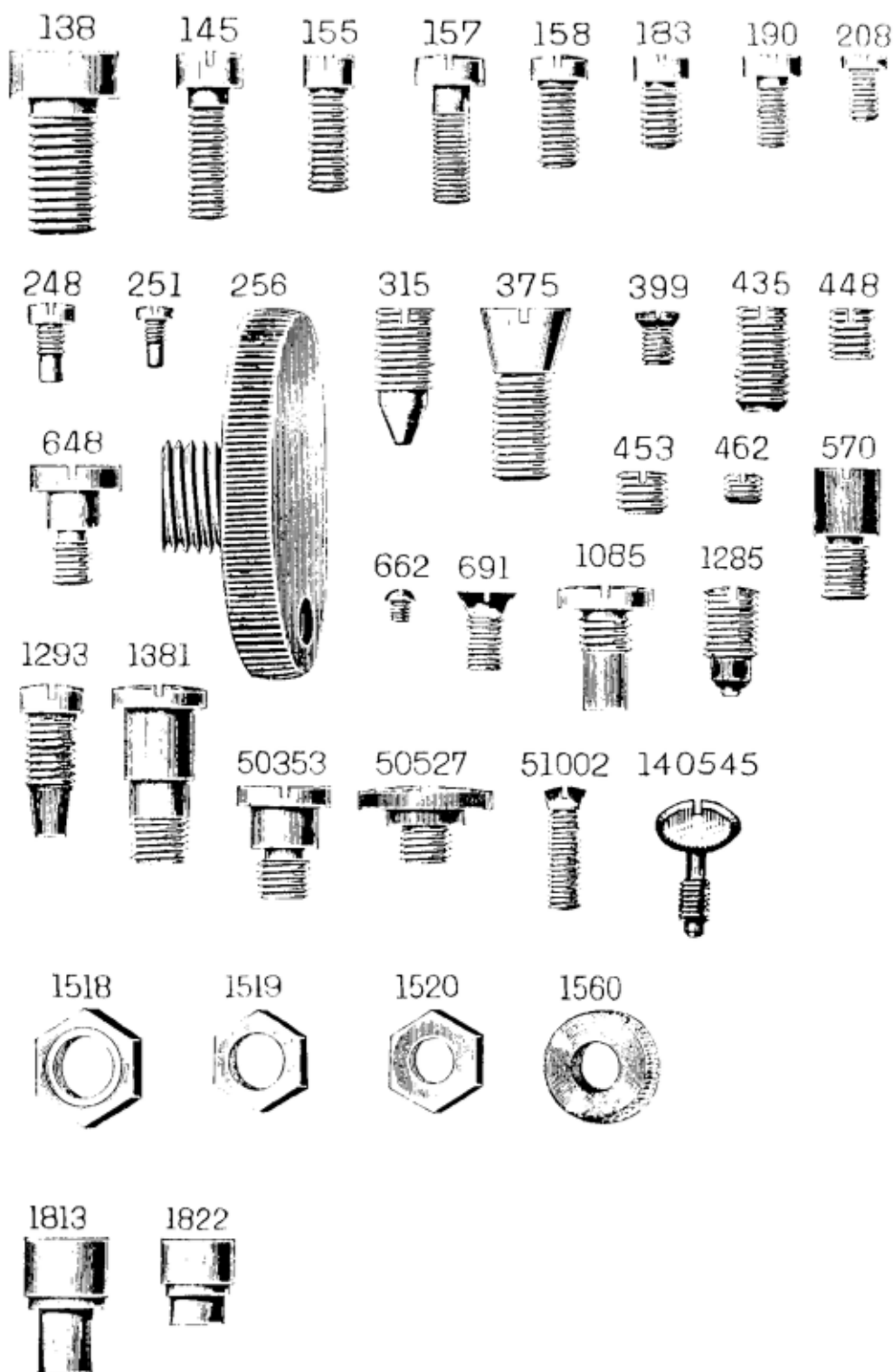

86642

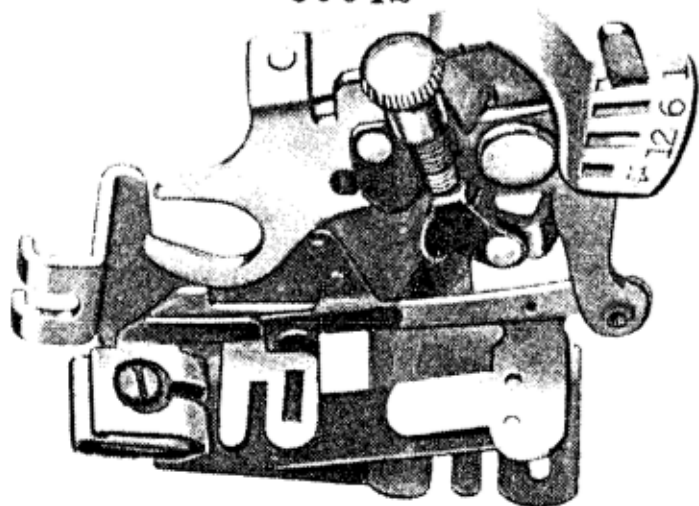

121441



36865

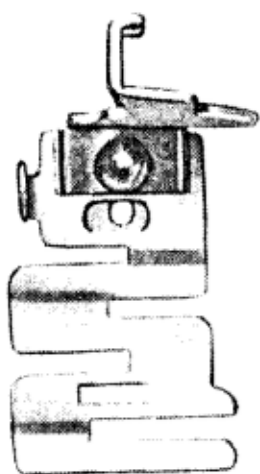

121464

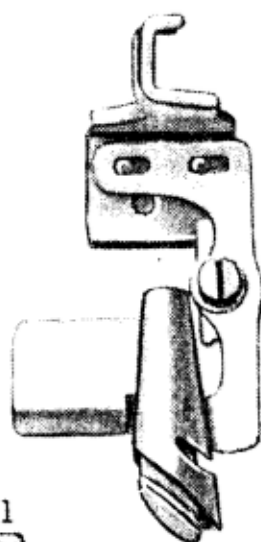

120378

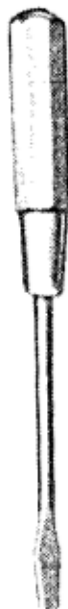

25537

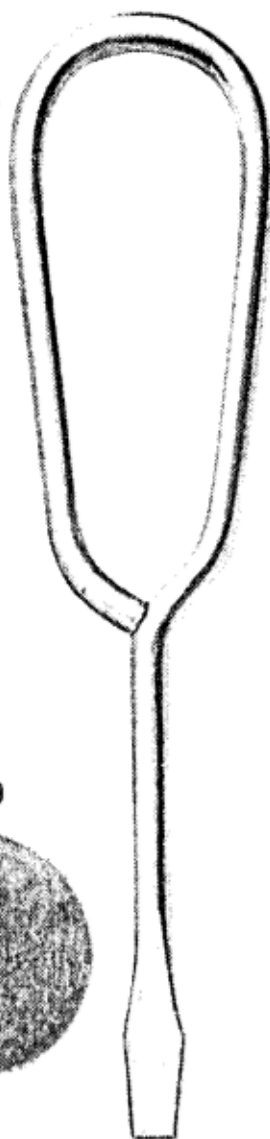

35931

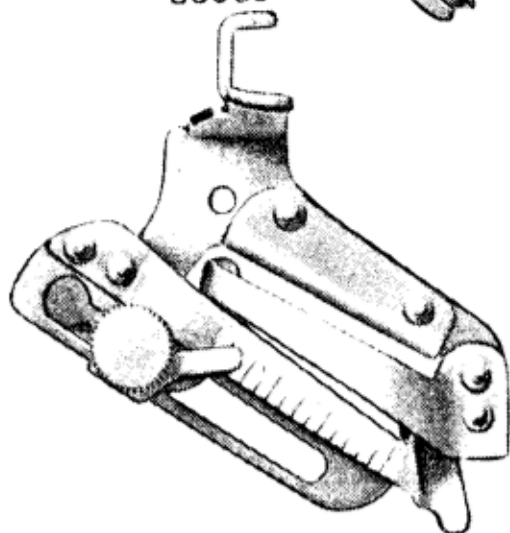

8879

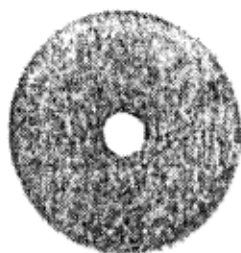

120914



120842



121094

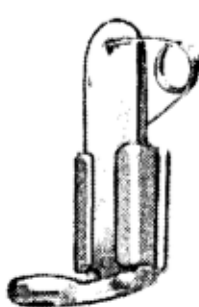

25539



121877

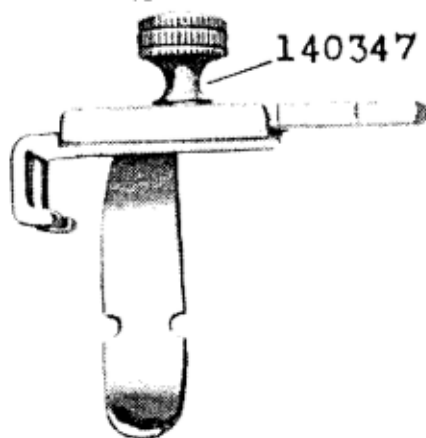

140347

125035



25525



25527

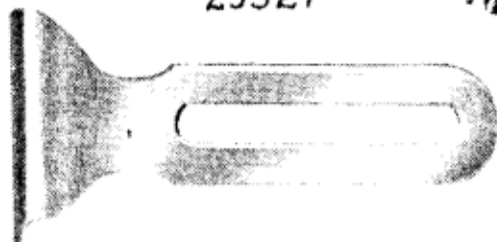

50053



35932

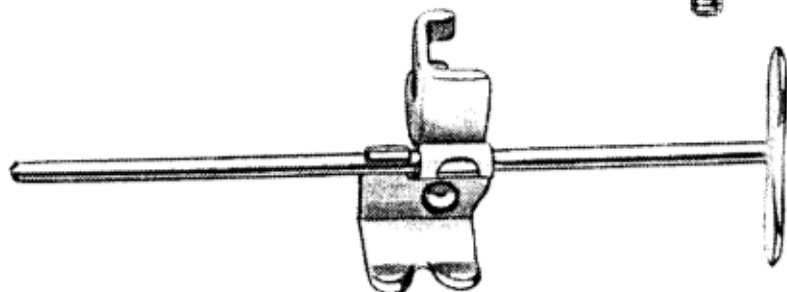

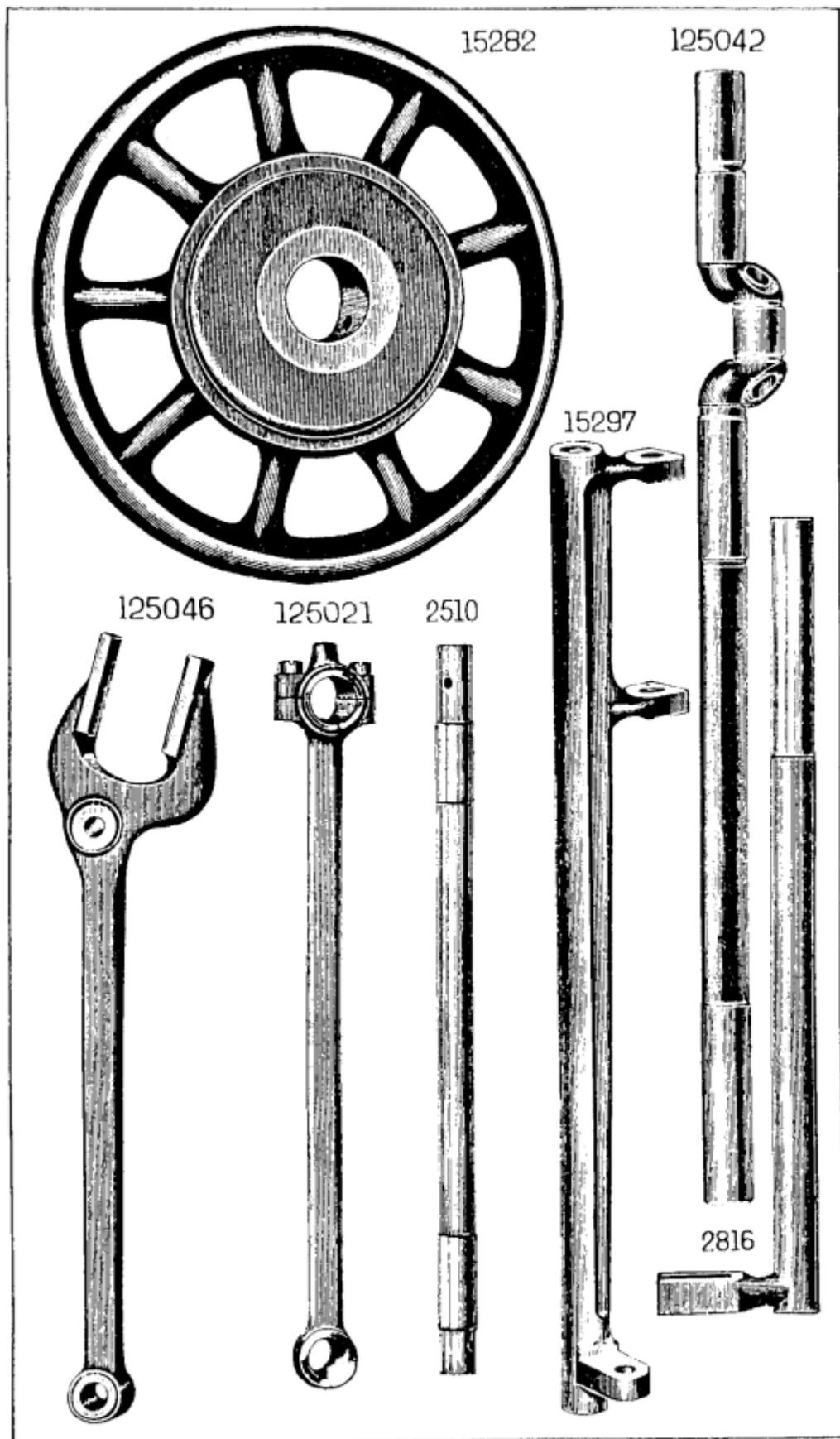

15272



15313

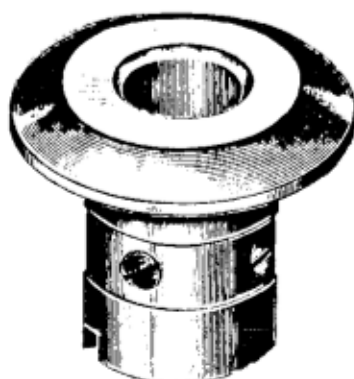

55621



2509

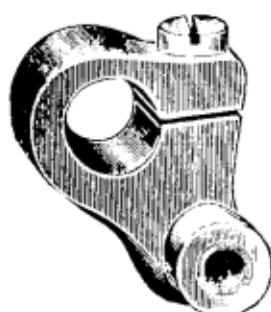

2052



2020

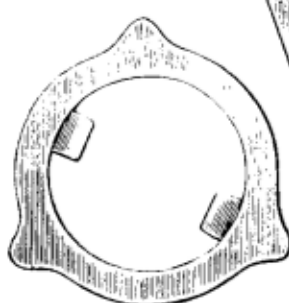

15486

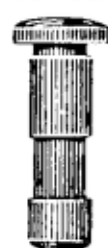

15491

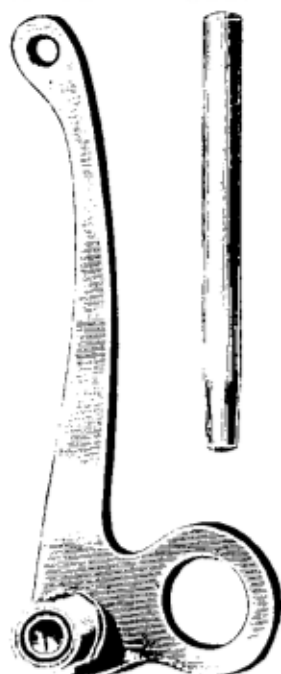

2007



15248



15498



2054



8217



125080

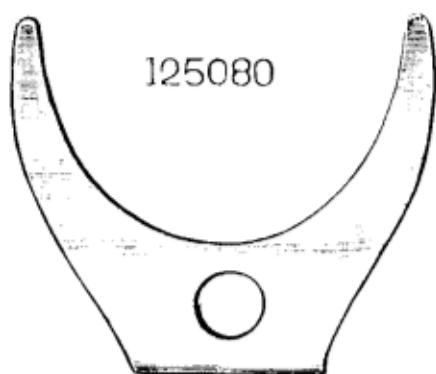

15280

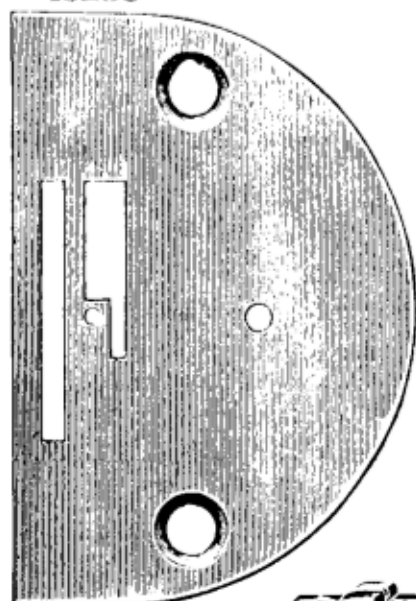

15279



45321



15281



120687



86079

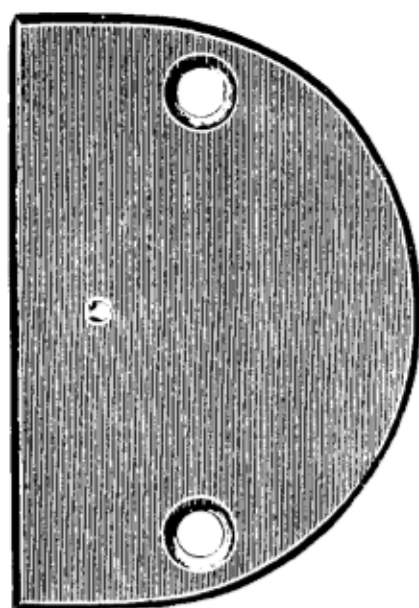

15359

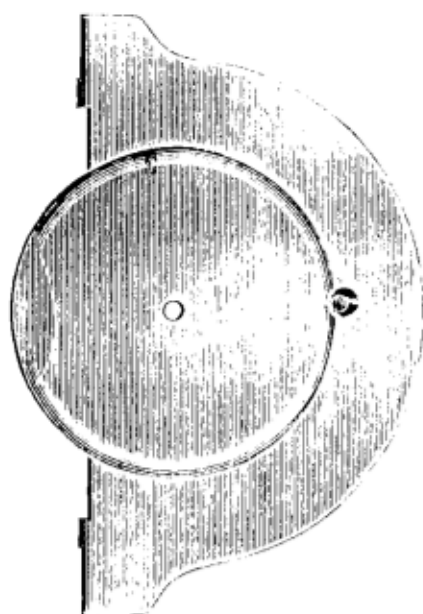

15147

2824

2002

4389

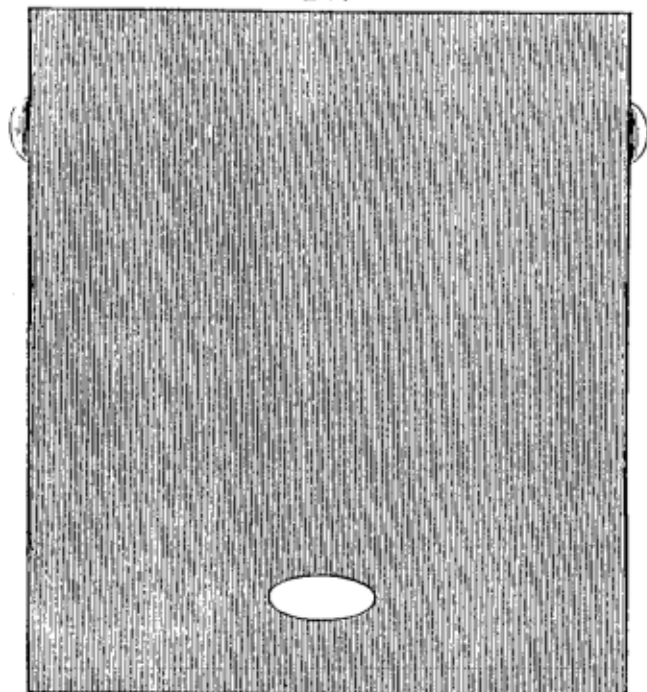

2049

2022



26075



80011

2068

51282

15238

15072

2102



125425

125095



32572



2070

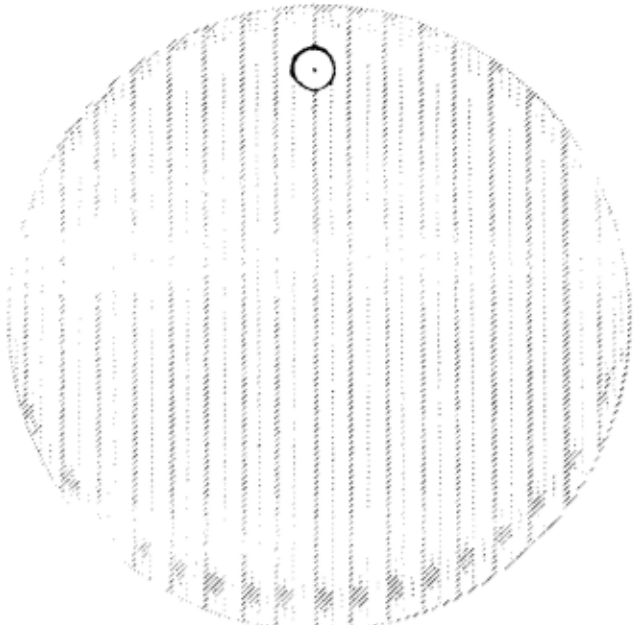

2530

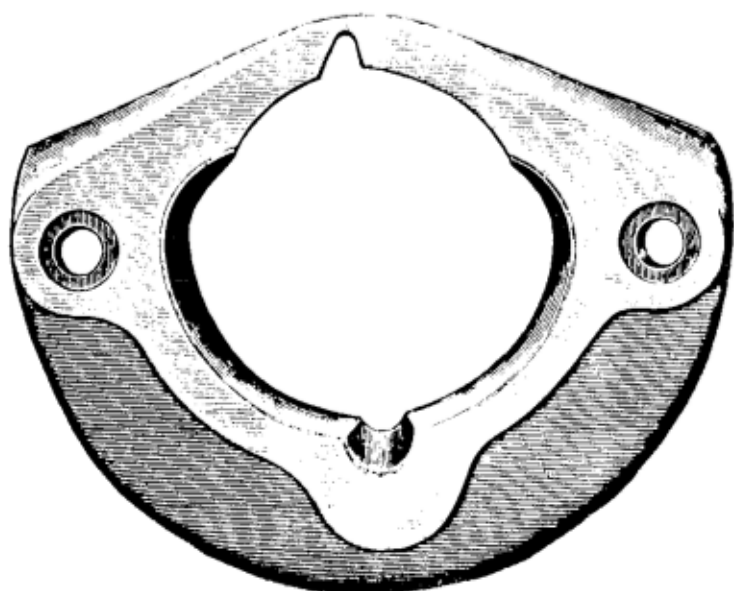

2535



2531

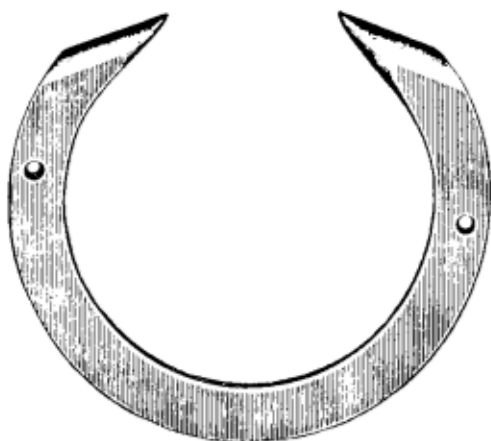

15277



2518

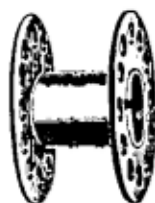

2515

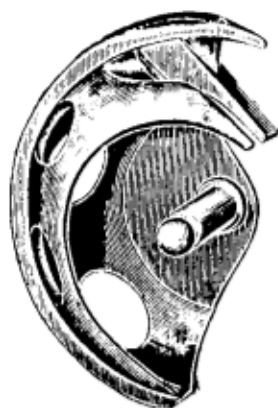

15278



15140



2532



2975



2974



591



592



125423



2973



125422

125424

ILLUSTRATED LIST OF PARTS
FOR
CLASS 15K MACHINES

CONTENTS

	Page
Parts, complete, for 15K80 to 15K82 Machines	31
Attachments	38
Bobbin Winder	37
Embroidery Hoops	40
Hand Attachment	41
Numerical List of Parts	45

INSTRUCTIONS FOR ORDERING

In ordering from this List, the prefix and affix letters with the part number **MUST BE** quoted exactly as they are shown in the first column.

A number always indicates the same part in whatever List it may appear, or for whatever machine.

The affix letters (where shown) indicate the style of finish, as follows :

- A. Hardened, Polished, Nickel Plated and Buffed.
- A.A. Buffed and Chromium Plated.
- A.B. Hardened, Polished, Buffed and Chromium Plated.
- A.C. Brown Baking Enamel Finish.
- A.D. Grey Baking Enamel Finish.
- A.E. Hardened, Bright Rumbled and Nickel Plated.
- A.F. Hardened, Bright Rumbled and Nickel Plated, Bright Rumbled and Chromium Plated.
- A.J. Polished, Nickel Plated and Chromium Plated.
- A.K. Hardened, Polished, Nickel Plated and Chromium Plated.
- A.L. Heat Treated for Toughness.
 - B. Polished, Nickel Plated and Buffed.
 - C. Hardened only.
- C.R. Hardened and Merlized.
 - D. Polished only.
 - E. Soft, not Polished.
 - F. Hardened and Polished.
- F.J. Hardened, Polished and Nickel Plated.
 - G. Bright Rumbled and Nickel Plated.
- H. Blued.
- J. Nickel Plated only.
- K. Hardened and Nickel Plated.
- L. Brass Plated.
- M. Oxidized.
- N. Japanned, Dull.
- P. Japanned, Bright.
- P.P. Wrinkle Finish.
- R. Merlized.
- S. Cadmium Plated.
- T. Copper Plated.
- T.A. Hardened, Polished, Copper and Nickel Plated and Buffed
- T.B. Copper and Nickel Plated and Polished.
- T.J. Copper and Nickel Plated only.
- T.K. Hardened, Copper and Nickel Plated.
- T.L. Copper and Brass Plated.
- T.M. Copper Plated and Oxidized.
 - U. Zinc Plated.
 - V. Silver Plated.
- W. Polished and Nickel Plated.
- X. Black Oxide for Iron and Steel.
- X.C. Hardened and Black Oxide for Iron and Steel.
 - Y. Black Nickel Plated only.
- Z. Chromium Plated.
- Z.A. Hardened, Polished, Nickel Plated, Buffed and Chromium Plated
- Z.B. Polished, Nickel Plated, Buffed and Chromium Plated
- Z.C. Hardened and Chromium Plated.
- Z.D. Polished and Chromium Plated.
- Z.G. Bright Rumbled, Nickel Plated, Bright Rumbled and Chromium Plated.
- Z.J. Nickel and Chromium Plated.
- Z.T. Copper and Chromium Plated.

Parts marked with an asterisk () are furnished only when the repairs are made at Factory.*

PARTS COMPLETE
FOR
Nos. 15K80 to 15K82 MACHINES
(G.B. SHUTTLE)

DROP FEED, FOR FAMILY USE

No.	Plate						
*125037	--	Arm	with 435c, 448c, 15486 and 15498
<i>NOTE. - In ordering it is necessary to state the Class and Variety number of machine.</i>							
2002	2580	Arm Dowel Pin	(2)
4380	2580	" "	" (for repairs only)
125038	1879	"	Oil Tube (for oiling back bearing)
125039	1879	" "	" Wick (felt)
125041	1879	" "	" " Spring
438c	2502	"	Screw (3)
125042	2577	"	Shaft
15498	2578	" "	Bushing
435c	2502	" "	" Position Screw
125425b	2580	Arm Side Cover	
51224b	1880	" "	" Thumb Screw
2007b	2578	"	Spool Pin
8879	2574	" "	" Washer (cloth)
15282b	2577	Balance Wheel, 2 1/4"	pulley, for 15K80 and 15K81 Machines
32672	1722	" "	3 1/4" " " 15K82 Machine
*125043		Bed	
<i>NOTE. - In ordering it is necessary to state the Class and Variety number of machine.</i>							
256b	2502	Clamp Stop Motion Clamp Screw	
248a	2502	" "	" " Stop Screw
2020	2578	" "	" " Washer
*15312		" "	" " Flanged Bushing
15313	2578	" "	" " " 15312 with two 462d
2022	2580	" "	" " " Pin
462d	2502	" "	" " " Set Screw

No.	Plate								
15314b	—	Clamp Stop Motion , complete, Nos. 248a, 256b, 2020 and 15313							
125021	2577	Crank Connecting Rod with 125012, 125044 and two 896e							...
*125012	—	" " " Cap							...
896e	1880	" " " " Screw							...
375c	2502	" " " Hinge Screw							...
1518j	2502	" " " " " Nut							...
125044	—	" " " Oil Pad (felt)							...
*15406b	1399	Face Plate							...
15407b	—	" " 15406b with 15428b							...
15432b	—	" " 15407b " 857b, 15410, 15412, 50292b and 125423b							...
*15408b	—	" " Tension Seat							...
15428b	1399	" " " " 15408b with 15395b							...
190b	2502	" " Screw							...
125422b	2581	" " Thread Guard							...
125423b	2581	" " " " 125422b with 125424b							...
125424b	2581	" " " " Rivet							...
55644b	—	Face Plate , complete, Nos. 1560g, 13710, 15238, 15432b, 32572, 50291j, 55645 and two 2102							...
2835	792	Feed Bar							...
315c	2502	" " Screw Centre (2)							...
1519j	2502	" " " " Nut (2)							...
125045	1879	Feed Cam and Counterbalance with 1285c							...
1285c	2502	" " Set Screw							...
15279	2579	Feed Dog , 12 teeth (14 teeth to the inch, three teeth at right of needle, square corner)							...
208al	2502	" " Screw (2)							...
125046	2577	Feed Forked Connection							...
1381c	2502	" " " Hinge Screw (eccentric)							...
1520j	2502	" " " " " Nut							...
125047	1879	" " " Slide Block							...
125335	—	" " " " " 125047 with 1085e							...
1085e	2502	" " " " " Screw Stud							...
2816	2577	Feed Lifting Rock Shaft							...
2836	—	" " " " 2816 with 2509							...
125048	1880	" " " " Centre (left)							...
51246c	1880	" " " " " (") Set Screw							...
125049	1880	" " " " " (right)							...
51246c	1880	" " " " " (") Set Screw							...
2509	2578	" " " " Crank with 157j and 1813							...
157j	2502	" " " " " Clamping Screw							...
1813	2502	" " " " " Roller and Stud							...

No.	Plate								
125050	1879	Feed Regulator
8217	2578	" "	Friction Washer
50353e	2502	" "	Hinge Screw
51225b	1880	" "	Thumb Screw
125036	1879	" "	" "	Washer
15297	2577	Feed Rock Shaft
125048	1880	" " "	Centre (left)
51246c	1880	" " "	" "	(") Set Screw
125049	1880	" " "	" "	(right)
51246c	1880	" " "	" "	(") Set Screw
51045c	1880	Machine Hinge Connection Set Screw (2)
125079	1879	Needle Bar
125052	1879	" "	Bushing
125072	-	" "	"	Oil Pad (felt)
1498c	1880	" "	"	Set Screw
15248	2578	" "	Connecting Link with 51002e
15374	-	" "	" "	15248 with 2052
51002e	2502	" "	" "	Adjusting Screw
570c	2502	" "	" "	Hinge Screw
1520j	2502	" "	" "	" " " Nut
2052	2578	" "	"	Stud with 155c
155c	2502	" "	" "	Set Screw
125095b	2580	" "	Thread Guard
251a	2502	" "	" "	Screw
2054	2578	Needle Clamp with 14054c
14054c	2502	" "	Thumb Screw
125055	1879	Oscillating Rock Shaft with 125056
125048	1880	" " "	Centre (left)
51246c	1880	" " "	" "	(") Set Screw
125049	1880	" " "	" "	(right)
51246c	1880	" " "	" "	(") Set Screw
125056		" " "	" "	Oil Wick (braided cotton)
2510	2577	Oscillating Shaft
125063	-	" "	"	2510 with 2049 and 125062
*125086		" "	"	125063 with 125058, 125065 and two 51229c
*125057		" "	"	Crank
*125058		" "	"	125057 with 462a and 125330
125059	1880	" "	"	125057 with 125330 and two 462a
2049	2580	" "	"	Pin
462a	2502	" "	"	Set Screw

No.	Plate								
15170	1879	Oscillating Shaft Crank Slide Block
125330	---	"	"	"	"	"	15170 with 125060
125060	1879	"	"	"	"	"	Stud
125061	1879	Presser Bar
55621b	2578	"	"	Lifter
15486	2578	"	"	"	Hinge Stud
448c	2502	"	"	"	"	"	Set Screw
80011	2580	"	"	Spring
2068	2580	"	"	"	Bracket with 453e
453c	2502	"	"	"	"	"	Set Screw
2070	2580	"	"	"	Washer
15281b	2579	Presser Foot
51224b	1880	"	"	Thumb Screw
45329	---	Presser Foot Hinge Pin
45319	-	"	"	Plate
45320	-	"	"	Shank
45321	2579	Presser Foot (hinged), complete, Nos. 45319, 45320 and 45329
<i>NOTE. No. 15321 is sent with machine unless otherwise specified on order</i>									
51228b	1880	Pressure Regulating Thumb Screw
66773	---	"	"	"	"	"	51228b with 66752
66752	1880	"	"	"	"	"	Plug (felt)
2515	2581	Shuttle Body
2518	2581	"	Bobbin
15277	2581	"	"	Case with 591f, 592e, 2975, 15141 and 15278
15141	-	"	"	"	Hinge, complete, Nos. 2973, 2974 and 15140
15140	2581	"	"	"	Latch
2973	2581	"	"	"	"	"	Lever
2974	2581	"	"	"	"	"	Fulcrum Pin
2975	2581	"	"	"	"	"	Spring
592e	2581	"	"	"	"	"	Stop Screw
591f	2581	"	"	Tension Regulating Screw
15278	2581	"	"	Spring
125018	---	Shuttle, complete, 1 1/8" diam., Nos. 2515, 2518 and 15277
*125062	---	Shuttle Driver
125064	1880	"	"	125092 with 125065 and two 51229c
125092	-	"	"	125062 with two 462al
125065	1880	"	"	Cushion Spring
51229c	1880	"	"	"	"	"	Screw
2049	2580	"	"	Pin
462al	2502	"	"	Set Screw

Bobbin Winder

for Balance Wheel No. 15282 or No. 32672

for 15K80 to 15K82 Machines

No.	Plate	
15072	2580	Bobbin Position Pin
^Δ 125324	1955	Bracket (belt cover)
158c	2502	" Screw (2)
66670	1955	Frame
125366	—	" 66670 with 15288 and 125068
51319b	1955	" Hinge Screw
66601	1955	" Spring
15287	1955	Friction Ring (rubber)
15288	1955	Pulley
125068	1955	Spindle with 15072
2007	2578	Spool Pin
8879	2574	" " Washer (cloth)
125376	1955	Stop Latch
51303b	1955	" " Hinge Screw
125462	1955	" " Spring
125395	1955	Tension Bracket
125396	---	" " complete, Nos. 45845 to 45847, 125395 and 140138b
193b	1880	" " Screw
7071	1955	" " Washer
45845	1955	" Disc
45847	1955	" " Spring
45846	1955	" " " Disc
140138b	1955	" Screw
125326	1955	Tripping Arm
190b	2502	" " Screw
†125327	1955	Bobbin Winder (automatic), complete, Nos. 190b, 15287, 51303b, 51319b, 66601, 125324, 125326, 125366, 125376 and 125462

† In ordering it is necessary to state class of machine.

ATTACHMENTS

Attachments and Accessories

(Supplied with Machine)

No.	Plate	
121464	2574	Binder
36865	2574	Edge Stitcher
121441	2574	Gathering Foot (double toe)
35931	2574	Hemmer (adjustable)
15 × 1	...	Needles (6)
86642	2574	Ruffler
25537	2574	Screw Driver (machine)
120378	2574	" " (bobbin case)
8879	2574	Spool Pin Washer (cloth)
160810	-	Set of Attachments, complete, Nos. 25537, 35931, 36865, 86642, 120378, 121441, 121464, two 8879 and six needles,
160811	-	Set of Attachments (less needles), complete, Nos. 25537, 35931, 36865, 86642, 120378, 121441, 121464 and two 8879
120842	2576	Hemmer (foot) $\frac{5}{64}$ " hem
2518	23	Shuttle Bobbin (3)
120861	-	Tin of Oil (3 oz.)

The following may be purchased separately :

25525	2576	Bias Gauge
25527b	2576	Cloth Guide
50053b	2576	" " and Under Braider Thumb Screw
120914	2576	Feller (foot)
35932	2576	Quilter
121170	909	Ruffler Shirring Plate
25539	2576	Stiletto
36583	1160	Tucker
121547	909	Under Braider

Art Work and Darning

No.	Plate	
85893	—	Embroidery Foot (for Art Work)
86079	2579	Feed Cover Plate
15359	2579	Feed Cover Plate
121094	2576	Darning Foot (spring)

Cording Feet ^{Slide Fastener Work}

FOR STITCHING ON EDGE AND INSERTING CORD

Cancelled, use 160846

No.	Plate	
125035	2576	Presser Foot for sewing on left side of needle
160845	—	Presser Foot (left toe)	—	—	—	—
160846	—	" " (right toe)	—	—	—	—
121875	—	Presser Foot <i>obsolete</i>
140347w	2576	" " Adjusting Thumb Screw <i>obsolete</i>
121876	—	" " Body <i>obsolete</i>
121877	2576	Presser Foot (adjustable for sewing on the right or left side of the needle), complete, Nos. 121875, 121876 and 140347w, for Cording and Slide Fastener Work <i>obsolete, use 161127</i>

Darning Presser

No.	Plate	
86493	1160	Needle Clamp with 140545k
140545k	1160	" " Screw
86494	1160	" " Stripper Spring
86495	1160	" " " " Eyelet
86496	1160	Darning Presser, complete, Nos. 86493 to 86495

Imitation Hemstitching Attachment

No.	Plate	
120687	2579	with Yielding Presser Plate

PRESSER FOOT

(for Cording and Slide Fastener Work)

No.	Plate	
140728	—	Presser Foot Adjusting Thumb Screw
161122	—	" " " " " Spring

101336	---	Embroidery Hoop (inner) for 87586
101337	---	" " (outer) for 87586
101338	---	" " (inner) for 87589
101339	---	" " (outer) for 87589
101340	---	" " (inner) for 87593
101341	---	" " (outer) for 87593
101342	---	" " (inner) for 87595
101343	---	" " (outer) for 87595
101344	---	" " (inner) for 87597
101345	---	" " (outer) for 87597
101346	---	" " (inner) for 96416
101347	---	" " (outer) for 96416
101358	---	" " (inner) for 96422
101359	---	" " (outer) for 96422

101348	---	Embroidery Hoop (inner) for 96417
101349	---	" " (outer) with SS528j, NN95j, two 96125 and four 96427, for 96417
101350	---	" " (inner) for 96418
101351	---	" " (outer) with SS528j, NN95j, two 96426 and four 96427, for 96418
101352	---	" " (inner) for 96419
101353	---	" " (outer) with SS528j, NN95j, two 96426 and four 96427, for 96419
101354	---	" " (inner) for 96420
101355	---	" " (outer) with SS528j, NN95j, two 96426 and four 96427, for 96420
101356	---	" " (inner) for 96421
101357	---	" " (outer) with SS528j, NN95j, two 96844 and four 96845, for 96421
101360	---	" " (inner) for 96423
101361	---	" " (outer) with SS528j, NN95j, 96425, 96426 and four 96427, for 96423
101362	---	" " (inner) for 96424
101363	---	" " (outer) with SS528j, NN95j, 96425, 96426 and four 96427, for 96424

EMBROIDERY HOOP (with Spring) (BIRCH)

No.	Plate	
101364	---	Hoop (inner) for 101246
101365	---	" (outer) with Spring, for 101246
101246	---	" (round) 10" diam. \times $\frac{1}{16}$ " high, complete, Nos. 101364 and 101365

(for Cording and Slide Fastener Work)

No.	Plate							
140728	---	Presser Foot Adjusting Thumb Screw			
161122	--	" " " " " Spring			
161123	---	" " Hinge Pin			
161124	--	" " Plate			
161125	---	" " Shank (adjustable)			
161126	---	" " " (stationary)			
161127	..	Presser Foot (hinged, adjustable) for sewing on the right or left side of the needle, complete, Nos. 140728 and 161122 to 161126						

Numerical List of Parts

No.	Plate	
NN95j	2399	Embroidery Hoop Clamping Bracket Screw Nut for 96417 to 96421, 96423 and 96424 <i>101349, 101351,</i>
138e	2502	Arm Screw ... <i>101353, 101355, 101357, 101361, 101363</i>
145d	2502	Shuttle Race Screw ...
155c	2502	Needle Bar Connecting Stud Set Screw for 2052 ...
157j	2502	Feed Lifting Rock Shaft Crank Clamping Screw for 2509 ...
158e	2502	Bobbin Winder Bracket Screw ...
183e	2502	Hand Attachment Body Bracket Screw for 94052b ...
190b	2502	Bobbin Winder Tripping Arm Screw for 125327 ...
190b	2502	Face Plate Screw ...
193b	1880	Bobbin Winder Tension Bracket Screw ...
208al	2502	Feed Dog Screw ...
248a	2502	Clamp Stop Motion Clamp Stop Screw for 15314b ...
251a	2502	Needle Bar Thread Guard Screw ...
256b	2502	Clamp Stop Motion Clamp Screw for 15314b
315c	2502	Feed Bar Screw Centre ...
375c	2502	Crank Connecting Rod Hinge Screw ...
399a	2502	Hand Attachment Gear Cover Screw for 94052b ...
435c	2502	Arm Shaft Bushing Position Screw for 125037
448c	2502	Presser Bar Lifter Hinge Stud Set Screw for 125037 ...
453c	2502	Presser Bar Spring Bracket Set Screw for 2068 ...
462al	2502	Clamp Stop Motion Flanged Bushing Set Screw for 15313 ...
462al	2502	Oscillating Shaft Crank Set Screw for 125058 and 125059 ...
462al	2502	Shuttle Driver Set Screw for 125092 ...
SS528j	2399	Embroidery Hoop Clamping Bracket Screw for 96417 to 96421, 96423 and 96424 <i>101349, 101351,</i>
SS565e	2114	Hand Attachment Driver Finger Latch Screw Stud for 94052b ... <i>101353, 101355,</i>
SS566e	2114	Hand Attachment Screw for 94052b ... <i>101357, 101361,</i>
SS567e	2114	Hand Attachment Driver Finger Driving Pad and Plate Binding Screw for 94041 <i>101363.</i>
570c	2502	Needle Bar Connecting Link Hinge Screw for 15434 ...

No.	Plate	
591f	2581	Shuttle Tension Regulating Screw for 15277
592e	2581	Shuttle Bobbin Case Latch Stop Screw for 15277
SS599f	2114	Hand Attachment Gear Screw Stud for 94052b
SS600f	2114	Hand Attachment Pinion Screw Stud (eccen- tric) for 94052b
648j	2502	Shuttle Race Back Spring Screw for 2528 ...
662d	2502	Shuttle Race Cap Screw for 15437 ...
691a	2502	Throat Plate Screw
857b	1399	Thread Take-up Spring Regulator Adjusting Screw for 15432b
896e	1880	Crank Connecting Rod Cap Screw for 125021
1085e	2502	Feed Forked Connection Slide Block Screw Stud for 125335
1285c	2502	Feed Cam Set Screw for 125045
1381c	2502	Feed Forked Connection Hinge Screw (eccentric)
1498c	1880	Needle Bar Bushing Set Screw
1518j	2502	Crank Connecting Rod Hinge Screw Nut ...
1519j	2502	Feed Bar Screw Centre Nut
1520j	2502	Feed Forked Connection Hinge Screw Nut
1520j	2502	Needle Bar Connecting Link Hinge Screw Nut for 15434
1560g	2502	Tension Regulating Thumb Nut for 55644b
1813	2502	Feed Lifting Rock Shaft Crank Roller and Stud for 2509
1822	2502	Thread Take-up Lever Roller and Stud for 15491b
2002	2580	Arm Dowel Pin
2007	2578	Bobbin Winder Spool Pin
2007b	2578	Arm Spool Pin
2020	2578	Clamp Stop Motion Clamp Washer for 15314b
2022	2580	Clamp Stop Motion Flanged Bushing Pin ...
2049	2580	Oscillating Shaft Crank Pin for 125063 ...
2049	2580	Shuttle Driver Pin
2052	2578	Needle Bar Connecting Stud with 155c for 15374
2054	2578	Needle Clamp with 140545c
2068	2580	Presser Bar Spring Bracket with 453c ...
2070	2580	Presser Bar Spring Washer
2102	2580	Tension Disc for 55644b
2509	2578	Feed Lifting Rock Shaft Crank with 157j and 1813 for 2836
2510	2577	Oscillating Shaft for 125063
2515	2581	Shuttle Body for 125018

No.	Date			
2518	2581	Shuttle Bobbin for 125018
2528	—	Shuttle Race, complete, Nos. 648j, 2531, 15437 and 125080
2530	2581	Shuttle Race Body for 15437
2531	2581	Shuttle Race Back for 2528
2532	2581	Shuttle Race Back Position Pin for 15437
2535	2581	Shuttle Race Cap for 15437
2816	2577	Feed Lifting Rock Shaft for 2836
2824	2580	Shuttle Race Slide Spring for 15147b
2835	792	Feed Bar
2836	—	Feed Lifting Rock Shaft 2816 with 2509
2973	2581	Shuttle Bobbin Case Latch Lever for 15141
2974	2581	Shuttle Bobbin Case Latch Lever Fulcrum Pin for 15141
2975	2581	Shuttle Bobbin Case Latch Spring for 15277
1389	2580	Arm Dowel Pin (for repairs only)
7971	1955	Bobbin Winder Tension Bracket Screw Washer
8217	2578	Feed Regulator Friction Washer
8879	2574	Spool Pin Washer (cloth) for 160810 and 160811
13710	1399	Tension Spring for 55644b
15072	2580	Bobbin Winder Bobbin Position Pin for 125068
15140	2581	Shuttle Bobbin Case Latch for 15141
15141	—	Shuttle Bobbin Case Hinge, complete, Nos. 2973, 2974 and 15140 for 15277
15147b	2580	Shuttle Race Slide 15188b with 2824 and two 51282j
15170	1879	Oscillating Shaft Crank Slide Block for 125330
15188b	—	Shuttle Race Slide for 15147b
15238	2580	Tension Releasing Pin for 55644b
15248	2578	Needle Bar Connecting Link with 51002e for 15374
15272	2578	Thread Take-up Cam with 1293e for 15434
15277	2581	Shuttle Bobbin Case, with 591f, 592e, 2975, 15141 and 15278 for 125018
15278	2581	Shuttle Tension Spring for 15277
15279	2579	Feed Dog, 12 teeth (14 teeth to the inch, three teeth at right of needle, square corner)
15280b	2579	Throat Plate for 15279
15281b	2579	Presser Foot for 15279
15282b	2577	Balance Wheel 2 $\frac{1}{4}$ " pulley for 15K80 and 15K81 Machines
15287	1955	Bobbin Winder Friction Ring (rubber) for 125327

No.	Plate	
15288	1955	Bobbin Winder Pulley for 125366
15297	2577	Feed Rock Shaft
*15312	---	Clamp Stop Motion Flanged Bushing for 15313
15313	2578	Clamp Stop Motion Flanged Bushing 15312 with two 462a1 for 15314b
15314b	---	Clamp Stop Motion, complete, Nos. 248a, 256b, 2020 and 15313
15359	2579	Feed Cover Plate
15374	---	Needle Bar Connecting Link 15248 with 2052
*15395b	---	Tension Thread Guard for 15428b
*15406b	1399	Face Plate for 15407b
15407b	---	Face Plate 15406b with 15428b for 15432b ...
*15408b	---	Face Plate Tension Seat for 15428b
15410	1399	Tension Screw Stud Bushing for 15432b ...
15412	1399	Thread Take-up Spring Regulator for 15432b
15428b	1399	Face Plate Tension Seat 15408b with 15395b for 15407b
15432b	---	Face Plate 15407b with 857b, 15410, 15412, 50292b and 125423b for 55644b
15434	---	Thread Take-up Cam 15272 with 570c and 1520j
15437	---	Shuttle Race Body 2530 with 2535, two each 662d and 2532, for 2528
15486	2578	Presser Bar Lifter Hinge Stud for 125037 ...
15491b	2578	Thread Take-up Lever with 1822 for 15492b
15492b	---	Thread Take-up Lever 15491b with 50527c
15498	2578	Arm Shaft Bushing for 125037
25525	2576	Bias Gauge
25527b	2576	Cloth Guide
25537	2574	Screw Driver (machine) for 160810 and 160811
25539	2576	Stiletto
26075	2580	Thread Cutter and Holder
32572	2580	Tension Releasing Disc for 55644b
32672	1722	Balance Wheel, 3½" pulley, for 15K82 Machine
35931	2574	Hemmer (adjustable) for 160810 and 160811
35932	2576	Quilter
36583	1160	Tucker
36865	2574	Edge Stitcher for 160810 and 160811
45319	---	Presser Foot Plate for 45321
45320	---	Presser Foot Shank for 45321
45321	2579	Presser Foot (hinged), complete, Nos. 45319, 45320 and 45329
45329	---	Presser Foot Hinge Pin for 45321
45845	1955	Bobbin Winder Tension Disc for 125396 ...

No.	Plate	
45846	1955	Bobbin Winder Tension Disc Spring Disc for 125396
45847	1955	Bobbin Winder Tension Disc Spring for 125396
50053b	2576	Cloth Guide and Under Braider Thumb Screw
50291j	1399	Tension Screw Stud for 55644b
50292b	1399	Tension Screw Stud Set Screw for 15432b ...
50353e	2502	Feed Regulator Hinge Screw
50527c	2502	Thread Take-up Lever Hinge Screw for 15492b
51002e	2502	Needle Bar Connecting Link Adjusting Screw for 15248
51045c	1880	Machine Hinge Connection Set Screw ...
51224b	1880	Arm Side Cover Thumb Screw
51224b	1880	Presser Foot Thumb Screw
51225b	1880	Feed Regulator Thumb Screw
51228b	1880	Pressure Regulating Thumb Screw for 66773
51229c	1880	Shuttle Driver Cushion Spring Screw for 125064 and 125086
51246c	1880	Feed Lifting Rock Shaft Centre (left) Set Screw
51246c	1880	Feed Lifting Rock Shaft Centre (right) Set Screw
51246c	1880	Feed Rock Shaft Centre (left) Set Screw ...
51246c	1880	Feed Rock Shaft Centre (right) Set Screw
51246c	1880	Oscillating Rock Shaft Centre (left) Set Screw
51246c	1880	Oscillating Rock Shaft Centre (right) Set Screw
51282j	2580	Shuttle Race Slide Spring Screw for 15147b
51303b	1955	Bobbin Winder Stop Latch Hinge Screw for 125327
51319b	1955	Bobbin Winder Frame Hinge Screw for 125327
55531	2114	Hand Attachment Crank Lever Lock Pin Spring for 94051b
55621b	2578	Presser Bar Lifter
55644b	...	Face Plate, complete, Nos. 1560g, 13710, 15238, 15432b, 32572, 50291j, 55645 and two 2102
55645	1399	Thread Take-up Spring for 55644b ...
66601	1955	Bobbin Winder Frame Spring for 125327 ...
66670	1955	Bobbin Winder Frame for 125366 ...
66752	1880	Pressure Regulating Thumb Screw Plug (felt) for 66773

No.	Plate	
66773	---	Pressure Regulating Thumb Screw 51228b with 66752
80011	2580	Presser Bar Spring
80028	2114	Hand Attachment Pinion Dowel Pin for 94070
85893	-	Embroidery Foot (for Art Work) ...
86079	2579	Feed Cover Plate
86493	1160	Darning Presser Needle Clamp with 110545k for 86496
86494	1160	Darning Presser Needle Clamp Stripper Spring for 86496
86495	1160	Darning Presser Needle Clamp Stripper Spring Eyelet for 86496
86496	1160	Darning Presser, complete, Nos. 86493 to 86495
86642	2574	Ruffler for 160810 and 160811
87586	-	Embroidery Hoop (round, birch) 5 $\frac{1}{2}$ " diam. \times 7 $\frac{7}{8}$ " high <i>101336 & 101337</i> ...
87589	1221	Embroidery Hoop (round, birch) 8" diam. \times 7 $\frac{7}{8}$ " high <i>101338 & 101339</i> ...
87593	---	Embroidery Hoop (round, birch) 10" diam. \times $\frac{7}{16}$ " high <i>101340, & 101341</i> ...
87595	-	Embroidery Hoop (round, birch) 12" diam. \times $\frac{1}{2}$ " high <i>101342 & 101343</i> ...
87597	-	Embroidery Hoop (oval, birch) 12" \times 5 $\frac{1}{2}$ " 7 $\frac{7}{8}$ " high <i>101344 & 101345</i> ...
94016	2284	Hand Attachment Gear Cover for 94052b ...
94027	2284	Hand Attachment Body Bracket for 94052b
94028	2114	Hand Attachment Crank Handle (Wood) for 94034b
94029b	2114	Hand Attachment Crank Handle Spindle for 94034b
94030b	2114	Hand Attachment Crank Handle Spindle Flange (loose) for 94034b
94031a	2284	Hand Attachment Crank Lever for 94034b ...
94032	2114	Hand Attachment Crank Lever Lock Pin for 94051b
94033b	2114	Hand Attachment Crank Lever Lock Pin Head for 94051b
94034b	---	Hand Attachment Crank, complete, Nos. 94028, 94029b, 94030b and 94031a, for 94052b
94036	2114	Hand Attachment Driver Finger for 94041
94037	2114	Hand Attachment Driver Finger Latch for 94052b
94038	2114	Hand Attachment Driver Finger Latch Spring for 94052b

No.	Plate	
94039	2114	Hand Attachment Driver Finger Driving Pad (raw-hide) for 94041
94040	2114	Hand Attachment Driver Finger Driving Pad Plate for 94041
94041	---	Hand Attachment Driver Finger 94036 with SS567e, 94039 and 94040 for 94052b ...
94044	2114	Hand Attachment Driver Finger Hinge Pin for 94052b
94046	2114	Hand Attachment Driver for 94070 ...
94048	2114	Hand Attachment Pinion for 94070 ...
94050	2284	Hand Attachment Body for 94052b ...
94051b	2284	Hand Attachment Gear, with 55531, 94032 and 94033b, for 94052b
94052b	2284	Hand Attachment, complete, Nos. SS565e, SS566e, SS5991, SS600f, 94046, 94027, 94034b, 94037, 94038, 94041, 94044, 94050, 94051b, 94069, 94070, two each 183e and 399a
94069	2114	Hand Attachment Crank Hinge Pin for 94052b
94070		Hand Attachment Driver 94046 with 80028 and 94048, for 94052b
96416		Embroidery Hoop (round, birch) 7" diam. $\times 7^m$ high ... <i>10/346</i> \checkmark <i>10/347</i> ...
96417		Embroidery Hoop (round, birch) 5 $\frac{1}{2}$ " diam. $\times 7^m$ high with SS528j, NN95j, two 96425 and four 96427
96418		Embroidery Hoop (round, birch) 7" diam. $\times 7^m$ high with SS528j, NN95j, two 96426 and four 96427
96419		Embroidery Hoop (round, birch) 8" diam. $\times 7^m$ high with SS528j, NN95j, two 96426 and four 96427
96420		Embroidery Hoop (round, birch) 10" diam. $\times \frac{7}{8}$ " high with SS528j, NN95j, two 96426 and four 96427
96421		Embroidery Hoop (round, birch) 12" diam. $\times \frac{1}{2}$ " high with SS528j, NN95j, two 96844 and four 96845
96422	1221	Embroidery Hoop (oval, birch) 9" \times 4 $\frac{1}{2}$ " \times 7 m high ... <i>10/358</i> \times <i>10/359</i> ...
96423	---	Embroidery Hoop (oval, birch) 9" \times 4 $\frac{1}{2}$ " \times 7 m high with SS528j, NN95j, 96425, 96426 and four 96427
96424	---	Embroidery Hoop (oval, birch) 12" \times 5 $\frac{1}{2}$ " \times 7 m high with SS528j, NN95j, 96425, 96426 and four 96427

No.	Plate	
96425	2399	Embroidery Hoop Clamping Bracket for 96417, 96423 and 96424 101349, 101361, 101363
96426	2399	Embroidery Hoop Clamping Bracket for 101351, 101353, 101355, 101361, 101363, 96418 to 96420, 96423 and 96424 ...
96427	2399	Embroidery Hoop Clamping Bracket Rivet 101349, 101351, 101353, 101355, 101361, 101363 for 96417 to 96420, 96423 and 96424 ...
96844	2399	Embroidery Hoop Clamping Bracket for 96424 101357
96845	2399	Embroidery Hoop Clamping Bracket Rivet for 96424 101357
96417	—	Embroidery Hoop (round, birch) $5\frac{1}{2}$ " diam. \times $7\frac{7}{8}$ " high, complete, Nos. 101348 and 101349
96418	2193	Embroidery Hoop (round, birch) 7" diam. \times $7\frac{7}{8}$ " high, complete, Nos. 101350 and 101351
96419	—	Embroidery Hoop (round, birch) 8" diam. \times $7\frac{7}{8}$ " high, complete, Nos. 101352 and 101353
96420	—	Embroidery Hoop (round, birch) 10" diam. \times $7\frac{7}{8}$ " high, complete, Nos. 101354 and 101355
96421	—	Embroidery Hoop (round, birch) 12" diam. \times $\frac{1}{2}$ " high, complete, Nos. 101356 and 101357
96423	—	Embroidery Hoop (oval, birch) 9" \times 4 $\frac{1}{2}$ " \times 7 $\frac{7}{8}$ " high, complete, Nos. 101360 and 101361
96424	—	Embroidery Hoop (oval, birch) 12" \times 5 $\frac{1}{2}$ " \times 7 $\frac{7}{8}$ " high, complete, Nos. 101362 and 101363

No.	Plate	
101246	---	Embroidery Hoop (round, birch) 10" diam. x $\frac{7}{8}$ " high, complete, Nos. 101364 and 101365
101336	---	Embroidery Hoop (inner) for 87586
101337	---	Embroidery Hoop (outer) for 87586
101338	---	Embroidery Hoop (inner) for 87589
101339	---	Embroidery Hoop (outer) for 87589
101340	---	Embroidery Hoop (inner) for 87593
101341	---	Embroidery Hoop (outer) for 87593
101342	---	Embroidery Hoop (inner) for 87595
101343	---	Embroidery Hoop (outer) for 87595
101344	---	Embroidery Hoop (inner) for 87597
101345	---	Embroidery Hoop (outer) for 87597
101346	---	Embroidery Hoop (inner) for 96416
101347	---	Embroidery Hoop (outer) for 96416
101348	---	Embroidery Hoop (inner) for 96417
101349	---	Embroidery Hoop (outer) with SS528j, NN95j, two 96425 and four 96427, for 96417
101350	---	Embroidery Hoop (inner) for 96418
101351	---	Embroidery Hoop (outer) with SS528j, NN95j, two 96426 and four 96427, for 96418
101352	---	Embroidery Hoop (inner) for 96419
101353	---	Embroidery Hoop (outer) with SS528j, NN95j, two 96426 and four 96427, for 96419
101354	---	Embroidery Hoop (inner) for 96420
101355	---	Embroidery Hoop (outer) with SS528j, NN95j, two 96426 and four 96427, for 96420
101356	---	Embroidery Hoop (inner) for 96421
101357	---	Embroidery Hoop (outer) with SS528j, NN95j, two 96844 and four 96845, for 96421
101358	---	Embroidery Hoop (inner) for 96422
101359	---	Embroidery Hoop (outer) for 96422
101360	---	Embroidery Hoop (inner) for 96423
101361	---	Embroidery Hoop (outer) with SS528j, NN95j, 96425, 96426 and four 96427 for 96423

No.	Plate	
120378	2574	Screw Driver (bobbin case) for 160810 and 160811
120687	2579	Imitation Hemstitching Attachment with Yielding Presser Plate
120842	2576	Hemmer (foot), $\frac{5}{64}$ " hem
120864	...	Tin of Oil (3 oz.)
120944	2576	Feller (foot)
121094	2576	Darning Foot (spring)
121170	909	Ruffler Shirring Plate
121441	2574	Gathering Foot (double toe) for 160810 and 160811
121464	2574	Binder for 160810 and 160811
121547	909	Under Braider
121875	...	Presser Foot for 121877 <i>obsolete</i>
121876	...	Presser Foot Body for 121877 <i>obsolete</i>
121877	2576	Presser Foot (adjustable for sewing on the right or left side of the needle), complete, Nos. 121875, 121876 and 140347w, for Cording and Slide Fastener Work
		<i>obsolete, use 161127.</i>
*125012		Crank Connecting Rod Cap for 125021
125018	...	Shuttle, complete, $1\frac{11}{16}$ " diam., Nos. 2515, 2518 and 15277
125021	2577	Crank Connecting Rod with 125012, 125044 and two 896e
125029	...	Drip Pan (for Cover Set)
125035	2576	Presser Foot (for sewing on left side of needle) for Stitching on Edge and Inserting Cord
125036	1879	Feed Regulator Thumb Screw Washer
*125037	...	Arm with 435c, 448c, 15486 and 15498
125038	1879	Arm Oil Tube (for oiling back bearing)
125039	1879	Arm Oil Tube Wick (felt)
125041	1879	Arm Oil Tube Wick Spring
125042	2577	Arm Shaft
*125043	...	Bed
125044	...	Crank Connecting Rod Oil Pad (felt) for 125021
125045	1879	Feed Cam and Counterbalance with 1285c
125046	2577	Feed Forked Connection
125047	1879	Feed Forked Connection Slide Block for 125335
125048	1880	Feed Lifting Rock Shaft Centre (left)
125048	1880	Feed Rock Shaft Centre (left)
125018	1880	Oscillating Rock Shaft Centre (left)
125049	1880	Feed Lifting Rock Shaft Centre (right)
125049	1880	Feed Rock Shaft Centre (right)
125049	1880	Oscillating Rock Shaft Centre (right)

No.	Plat.	
125050	1879	Feed Regulator
125052	1879	Needle Bar Bushing
125055	1879	Oscillating Rock Shaft with 125056
125056		Oscillating Rock Shaft Oil Wick (braided cotton) for 125055
*125057	-	Oscillating Shaft Crank for 125058 and 125059
*125058		Oscillating Shaft Crank 125057 with 462d and 125330 for 125086
125059	1880	Oscillating Shaft Crank 125057 with 125330 and two 462d
125060	1879	Oscillating Shaft Crank Slide Block Stud for 125330
125061	1879	Presser Bar
*125062	---	Shuttle Driver for 125063 and 125092
125063	---	Oscillating Shaft 2510 with 2049 and 125062, for 125086
125064	1880	Shuttle Driver 125092 with 125065 and two 51229c
125065	1880	Shuttle Driver Cushion Spring for 125064 and 125086
125068	1955	Bobbin Winder Spindle with 45072 for 125366
125072		Needle Bar Bushing Oil Pad (felt)
125079	1879	Needle Bar
125080	2578	Shuttle Race Back Spring for 2528
*125086	---	Oscillating Shaft 125063 with 125058, 125065 and two 51229c
125092		Shuttle Driver 125062 with two 462d for 125064
125095b	2580	Needle Bar Thread Guard

No.	Plate
-----	-------

No.	Plate	
*125324	1955	Bobbin Winder Bracket (belt cover) for 125327
125326	1955	Bobbin Winder Tripping Arm for 125327 ...
*125327	1955	Bobbin Winder (automatic), complete, Nos. 190b, 15287, 51303b, 51319b, 66601, 125324, 125326, 125366, 125376 and 125462
125330		Oscillating Shaft Crank Slide Block 15170 with 125060, for 125058 and 125059 ...
125335		Feed Forked Connection Slide Block 125047 with 1085e
125366		Bobbin Winder Frame 66670 with 15288 and 125068, for 125327
125376	1955	Bobbin Winder Stop Latch for 125327 ...
125395	1955	Bobbin Winder Tension Bracket for 125396
125396		Bobbin Winder Tension Bracket, complete, Nos. 45845 to 45847, 125395 and 140138b
125422b	2581	Face Plate Thread Guard for 125423b ...
125423b	2581	Face Plate Thread Guard 125422b with 125424b, for 15432b
125424b	2581	Face Plate Thread Guard Rivet for 125423b
125425b	2580	Arm Side Cover
125462	1955	Bobbin Winder Stop Latch Spring for 125327

* In ordering, it is necessary to state class of machine.

No.	Plate	
140138b	1955	Bobbin Winder Tension Screw for 125396 ...
140347w	2576	Presser Foot Adjusting Thumb Screw for 121877 <i>obsolete</i>
140511a1	—	Thread Take-up Cam Timing Screw for 15272
140545c	2502	Needle Clamp Thumb Screw for 2054 ...
140545k	1160	Darning Presser Needle Clamp Screw for 86493
160810	---	Set of Attachments, complete, Nos. 25537, 35931, 36865, 86642, 120378, 121441, 121464, two 8879 and six needles ...
160811	---	Set of Attachments (less needles), complete, Nos. 25537, 35931, 36865, 86642, 120378, 121441, 121464 and two 8879 ...
101362	—	Embroidery Hoop (inner) for 96424 ...
101363	---	Embroidery Hoop (outer) with SS528j, NN95j, 96425, 96426 and four 96427, for 96424
101364	—	Embroidery Hoop (inner) for 101246 ...
101365	—	Embroidery Hoop (outer) with Spring, for 101246
140728	---	Presser Foot Adjusting Thumb Screw for 161127
161122	---	Presser Foot Adjusting Thumb Screw Spring for 161127
161123	—	Presser Foot Hinge Pin for 161127 ...
161124	—	Presser Foot Plate for 161127
161125	---	Presser Foot Shank (adjustable) for 161127
161126	---	Presser Foot Shank (stationary) for 161127
161127	—	Presser Foot (hinged, adjustable) for sewing on the right or left side of the needle, complete, Nos. 140728 and 161122 to 161126