

SINGER



Sewing Machine

201k

T H E S I N G E R C O M P A N Y

Instructions for Using

SINGER*

Form K6053
(1266)

All Rights Reserved

Printed in Great Britain

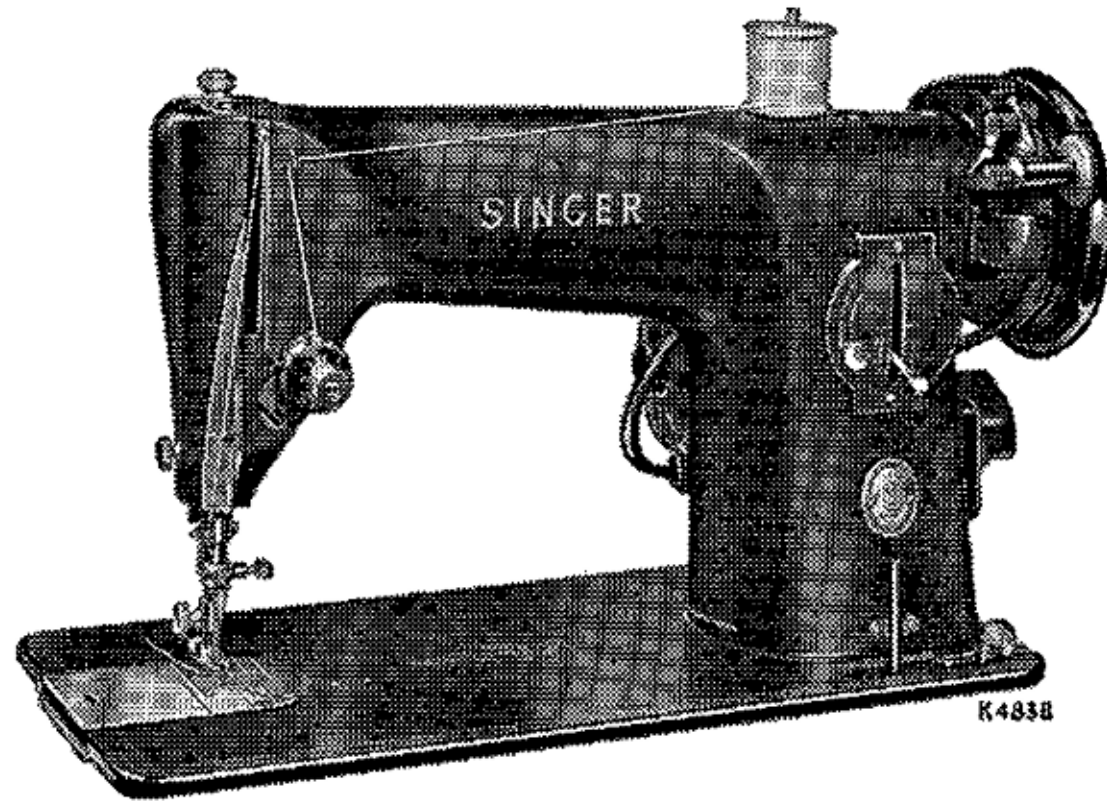

SEWING MACHINE 201K

The **SINGER 201K** is another in a long line of products resulting from the skill and ability of **SINGER** craftsmen.

***A Trademark of THE SINGER COMPANY**

WHEN YOU OWN A **SINGER** 201K MACHINE

you have a beautifully styled, smooth running machine which offers you a new world of sewing enjoyment. Exclusive dresses for yourself, clothing for your family, and numerous items for the home—all will be yours at a fraction of their ready-made cost.



TO GET THE MOST ENJOYMENT FROM YOUR **SINGER**

You are entitled to sewing lessons when you become the owner of a new **SINGER**. A skilled, **SINGER**-trained teacher personally guides you and assists you in learning the fundamentals of home sewing. Other courses embracing all phases of home sewing are available at low cost.

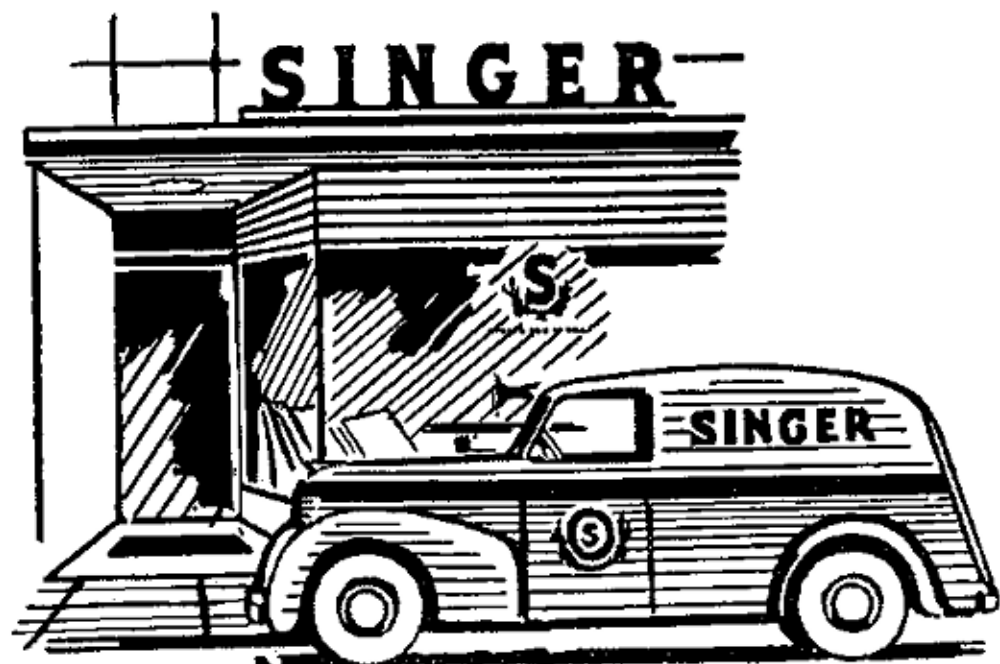

SINGER SERVICE

Wherever you go you will find expert, dependable **SINGER*** Service nearby. **SINGER** is interested in helping you keep your **SINGER** Sewing Machine in top condition. That is why you should always call your **SINGER SEWING CENTRE** if your machine ever requires adjustment or repair. When you call your **SINGER SEWING CENTRE** you can be sure of obtaining the service of a trained **SINGER** repair man and can be assured of warranted **SINGER*** parts

when needed! Look for the familiar red "S" Trade Mark on your **SINGER SEWING CENTRE** and the ever ready **SINGER** Service Car.

EVERYTHING FOR THE WOMAN WHO SEWS

The answer to your sewing needs is at your **SINGER SEWING CENTRE**. There you will find a wide choice of sewing necessities and notions, sewing instructions and guidance and services for covering buttons, hemstitching, making belts and buckles, to mention a few. Look in your telephone directory under **SINGER SEWING MACHINE COMPANY** for the **SINGER SEWING CENTRE** nearest you.



ELECTRICAL INFORMATION

The SINGER* Electric Motor

is located at the back of the machine, and can be supplied for operation on alternating or direct current. Orders must state the catalogue number of the motor, or the voltage, and in the case of alternating current, the number of cycles.

Before Inserting Electric Plug—

be sure that voltage and number of cycles stamped on motor nameplate are within range marked on electric meter installed by electric power company.

Electrical Connections for Machine

Push three-pin safety plug into three-pin terminal block at right of machine and connect plug at other end of cord to electric supply point.

Speed Controller

The speed of machine is regulated by amount of pressure on foot controller or knee controller.

CAUTION

When you have finished your sewing always disconnect the plug from the electric supply point.

LIGHT

To Turn Light "on" or "off."

To turn on light, reach over machine arm and turn switch **B**, **Fig. 1** clockwise. To extinguish light turn switch anti-clockwise.

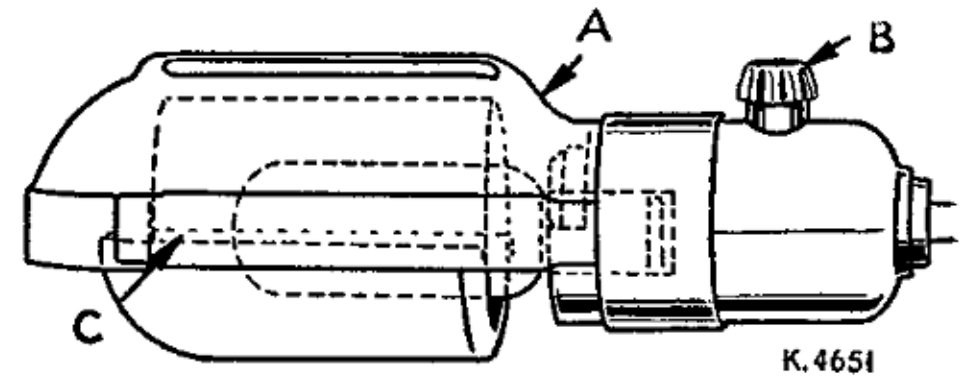

Fig. 1. Light.

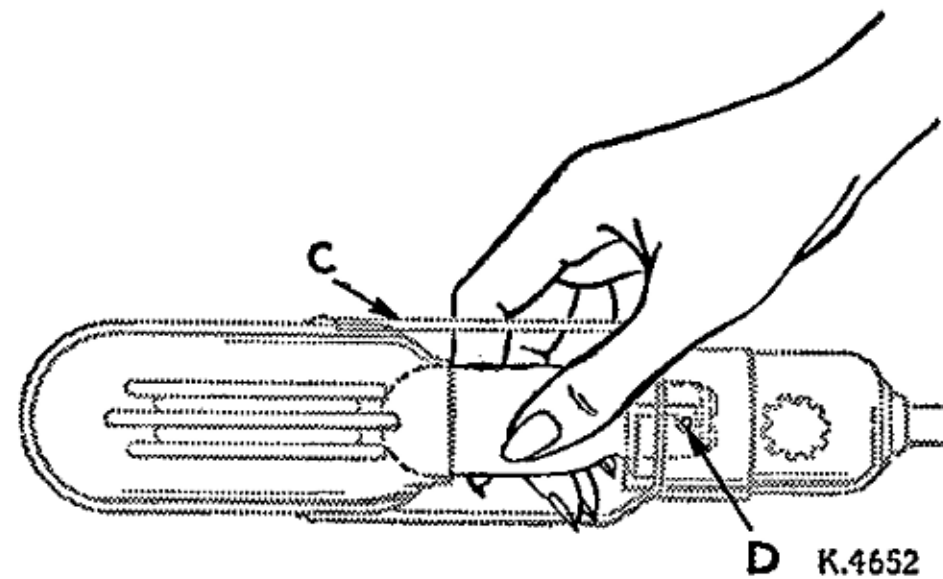

Fig. 2. Removing and replacing bulb.

To Remove Bulb

Grasp light socket so that thumb extends over switch **B**. Press shade with thumb at **A** to release shade from two catches, and slide it halfway out of shade holder **C**. Press bulb into socket and at same time turn bulb over from machine as far as it will go to unlock pin **D** (see **Figs. 3** and **4**). Withdraw the bulb.

To Insert New Bulb

Press bulb into socket and turn it over toward machine until pin **D** enters notch in socket (see **Fig. 3**). Return shade to its normal position as shown in **Fig. 1**.

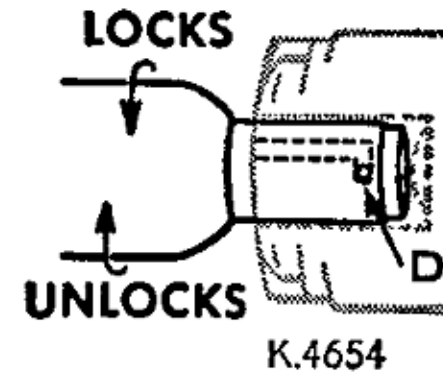

Fig. 3. Locking or unlocking bulb pin.

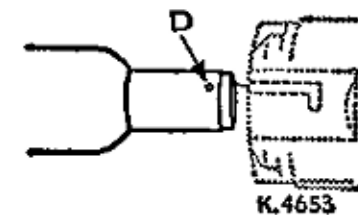

Fig. 4. Inserting bulb in socket.

IF MACHINE IS ELECTRICALLY OPERATED

Raise presser foot G by means of presser bar lifter J to prevent injury to the foot G and feed H.

Place a piece of material under presser foot and let the foot down upon it. Turn on electric current and, if the combination knee and foot controller is installed as a knee controller, press knee lever to the right. If controller is placed on the floor to be used as a foot controller, press down on pedal of controller. The speed of the machine is controlled entirely by the amount of pressure applied to the controller. Operate machine in this way, without being threaded, until you have become accustomed to guiding the material and operating the controller.

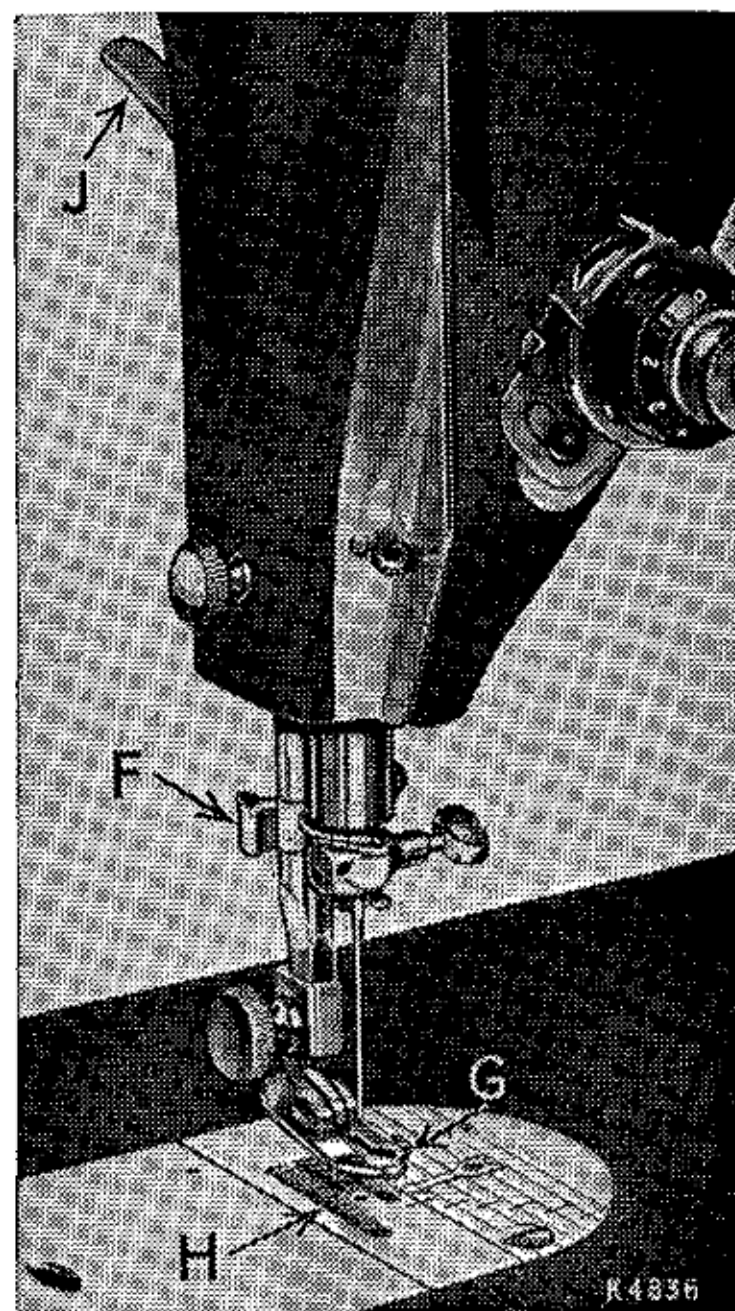

Fig. 5. Front view of machine.

IF MACHINE IS HAND OPERATED

When the machine is uncovered, the hand attachment will be found to be out of working position as shown in Fig. 6. Pull the small spring stud 2, and turn the handle back until the lever 1, enters the socket 3. Press back the hinged finger 4, Fig. 7 between the spokes of the wheel. The machine is now ready for working, as shown in Fig. 7.

NOTE. Before replacing the cover or the machine in its case, the lever should be disengaged and the handle placed in the position shown in Fig. 6.

TO OPERATE THE HAND MACHINE

Place a piece of material under the presser foot G, Fig. 5, and lower the latter by means of the lifter J.

Now turn the handle over from you to work the machine, without being threaded, until you are accustomed to guiding the material with the left hand.

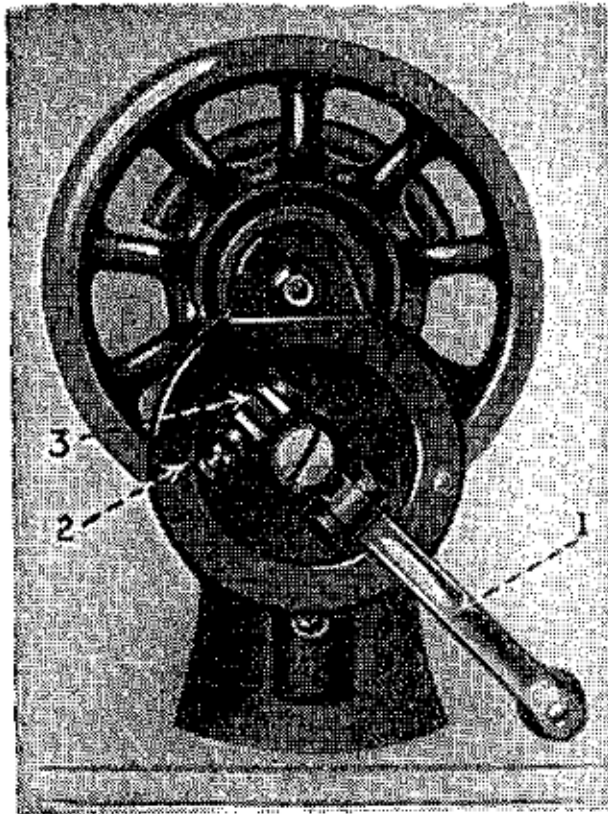

Fig. 6.

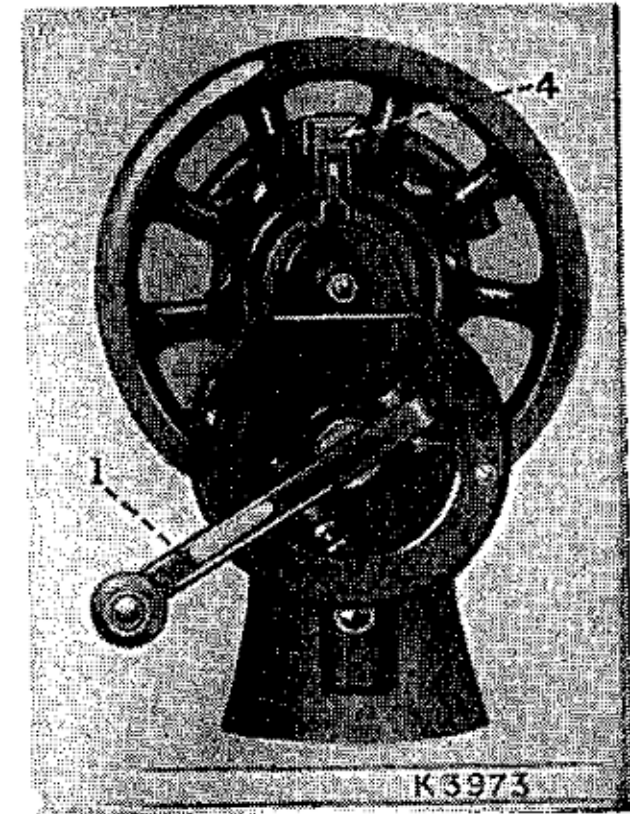

Fig. 7

IF MACHINE IS TREADLE OPERATED

Loosen the hand wheel by turning stop motion screw 17, Fig. 12, over toward you, place both feet upon the treadle and turn the hand wheel over toward you, at the same time allowing the feet to move freely and lightly with the motion of the treadle. Continue to do this until a regular and easy movement is acquired and you are able to work the treadle so that you can re-start the machine with the wheel turning toward you.

When familiar with the working movement, tighten the hand wheel by turning the stop motion screw over from you, and place a piece of material under the presser foot G, Fig. 5. Lower the latter by means of the lifter and again work the machine, without being threaded, until you are accustomed to guiding the material.

The belt should be only just tight enough not to slip. If too loose, shorten and rejoin.

BELT SHIFTER

This device simplifies throwing off and replacing the belt. To throw off the belt, move the belt shifter to the left (see Fig. 8), working the treadle at the same time. To replace the belt, work the treadle slowly with the hand wheel turning toward you, when a revolution or two of the wheel will bring the belt back into its place.

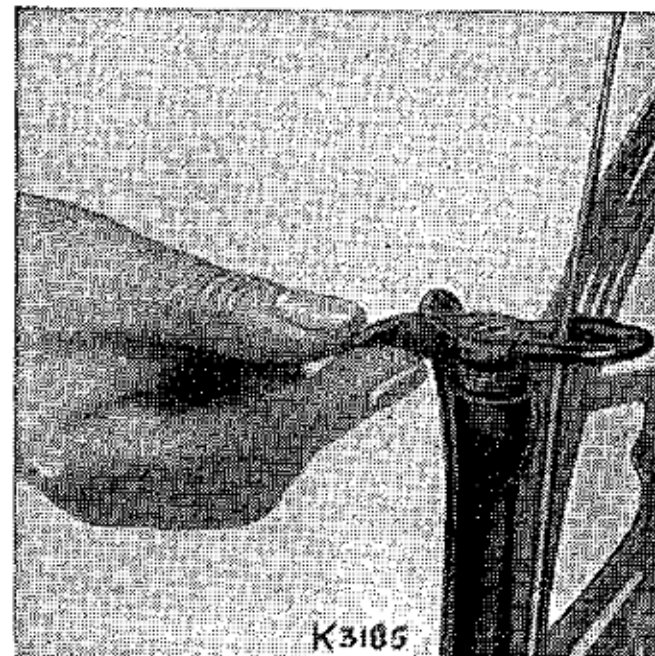

Fig. 8.

NEEDLES AND THREAD

This machine uses a 15x1 Needle—available in sizes 9, 11, 14, 16, 18, 19 and 21.

For perfect stitching, the thread should be selected according to the fabric to be stitched and the needle must be of the correct size for the thread which must pass freely through eye of needle. Select the correct needle according to the chart on page 11. Be sure that the needle is not blunt or bent.

TO SET THE NEEDLE

Raise needle bar to its highest position and loosen thumb screw **A** in needle clamp. Insert needle with its flat side to the left up into the needle clamp **B** as far as it will go, then tighten thumb screw **A**.

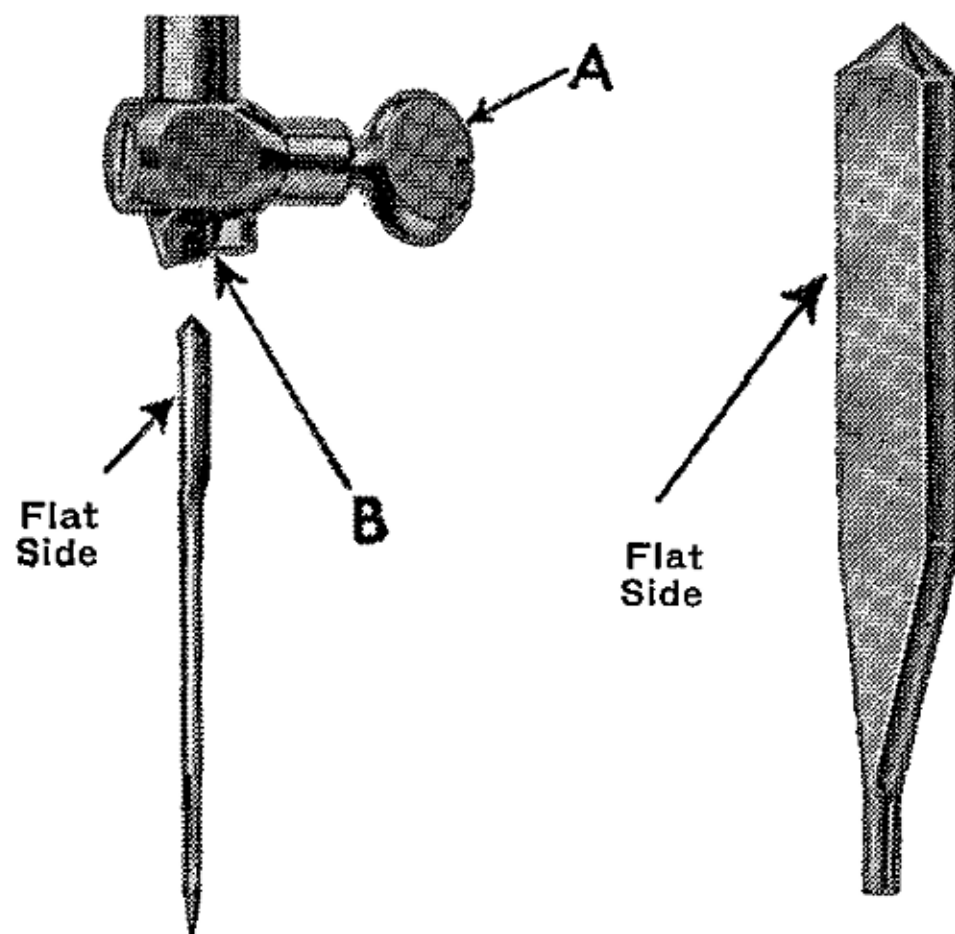

Fig. 9. Setting the Needle.

CHART SHOWING THE RELATIONSHIP OF TYPES OF FABRICS, THREAD AND NEEDLE SIZES AND MACHINE STITCHES TO THE INCH

Types of Fabrics	Thread Sizes	Needle Sizes	Machine Stitches per Inch	
			Inside Seams	Top Stitching
Very thin Silk, Muslin, Cambric, Lightweight Delicate Fabrics, etc.	100 to 150 Cotton, 50 Silk, 80 Mercerised Darning Cotton	9	20	25 to 30
Fine Calicoes, Linens, Shirtings, Fine Silk Goods, etc.	80 to 100 Cotton, 50 Silk, 50 Mercerised Darning Cotton	11	16	20
Plastic Materials	50 to 80 Mercerised Cotton	11	10	12
Shirtings, Sheetings, Bleached Calicoes, Silk and General Domestic Goods, Light Woollen Goods and all classes of general work	60 to 80 Cotton, 50 Silk, 50 Syiko	14	12	18
All kinds of heavy Calicoes, Drill, Woollen Goods, etc.	40 to 60 Cotton	16	10	12
Tickings, Heavy Woollens, Trousers, Boys' Clothing, Corsets, Cloaks, Mantles, Heavy Coats, and Heavy Clothing generally	24 to 40 Cotton, 60 to 80 Linen	18 or 19	8	10
Bags, Coarse Cloths, Canvas, Duck, Heavy Goods of any texture	40 to 60 Linen, or very coarse cotton	19 or 21	6	8

When ordering needles, always specify "Class and Variety 15x1" and state the size and quantity required. You will obtain the best stitching results from your Sewing Machine if it is fitted with a SINGER* Needle.

UPPER THREADING

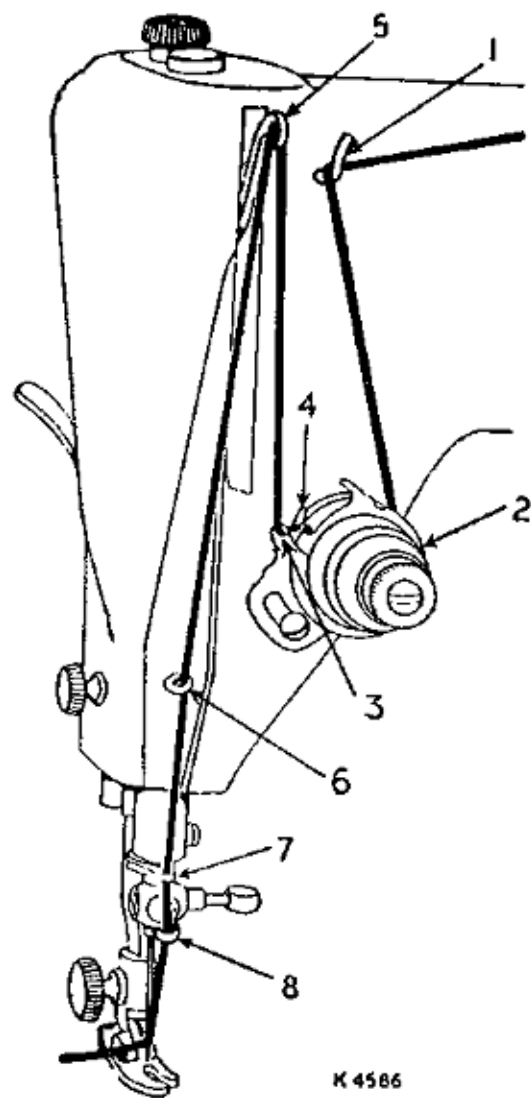

Fig. 10.

See Fig. 10.

Raise take-up lever 5 to its highest point.
Place spool of thread on spool pin.

Lead thread into thread guide 1.

Down and from right to left between
tension discs 2.

Into the loop of the take-up spring 3 and
to the right until it enters the fork 4.

Up and from right to left through hole
in take-up lever 5.

Down through guide 6 on face plate.

Down through guide 7 into guide 8.

From right to left through the eye of the
needle.

Draw about two inches of thread through
the eye of the needle with which to
begin sewing.

TO REMOVE BOBBIN

Raise the needle to its highest point.

Draw to the left the slide (C) in the bed of the machine and remove the bobbin with the thumb and forefinger of the left hand, as shown in Fig. 11.

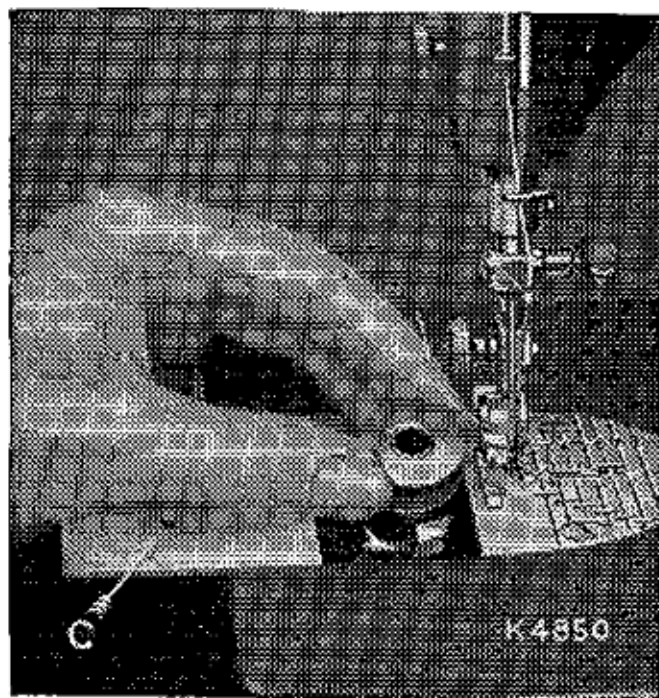

Fig. 11. Removing the Bobbin.

TO WIND BOBBIN. *See Fig. 12.*

1. Place bobbin on spindle with pin of spindle entering hole in right side of bobbin.
2. Lock bobbin in place by pressing bobbin winder down until latch 15, Fig. 12 engages.
3. Place spool of thread on spool pin 12. Draw thread under and between tension discs 13. Lead thread up through hole in bobbin 14 from the inside.
4. Hold hand wheel 16 and loosen knurled screw 17 by turning it over toward you.
5. Hold end of thread and operate machine as for sewing. Continue to hold end of thread until it breaks off.

Allow tension discs to control flow of thread. Do not guide or hold thread when winding bobbin.

The bobbin winder will stop automatically when the bobbin is filled.

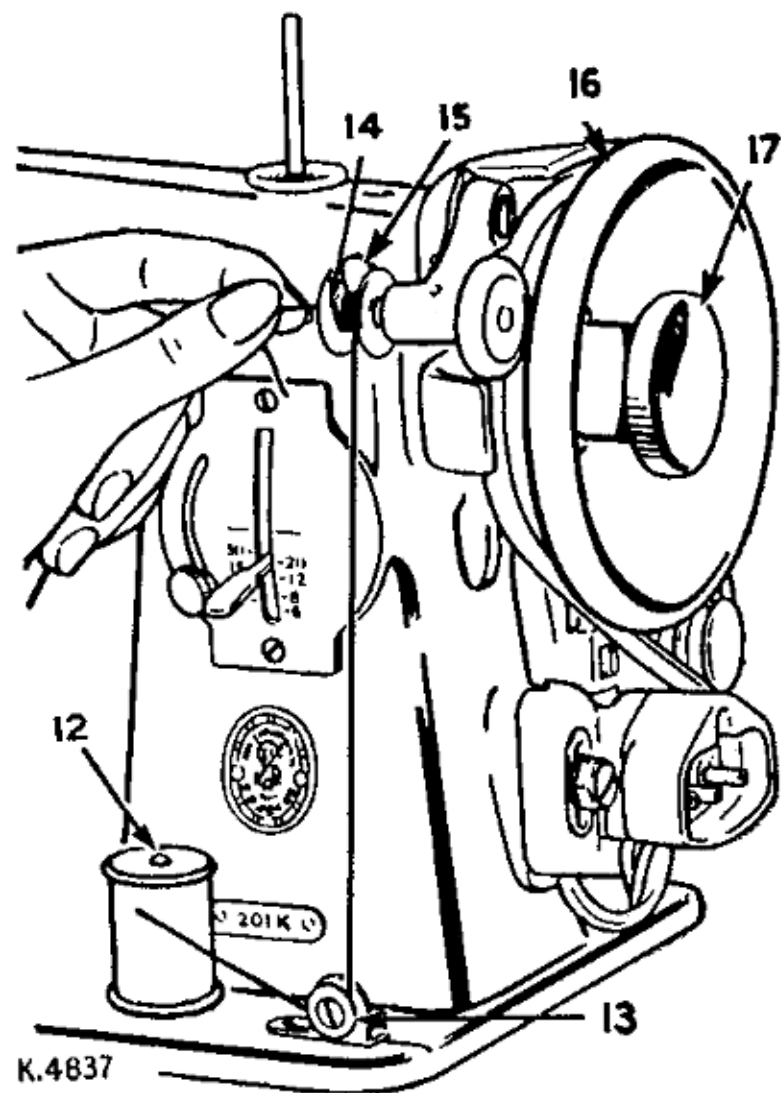

Fig. 12. Winding the Bobbin.

Remove bobbin from spindle and tighten knurled screw 17.

If pressure of bobbin winder pulley against hub of hand wheel is insufficient for winding the bobbin, press down bobbin winder until latch 15, Fig. 13 drops and holds it in position. Loosen adjusting screw 18, Fig. 13. With forefinger, push back upper end of slotted plate 19 as far as it will go, as shown in Fig. 13, and at the same time, press bobbin winder pulley against hub of hand wheel. Tighten adjusting screw 18. If thread does not wind evenly on bobbin, loosen screw which holds tension bracket 13, Fig. 12 in position. Move bracket to the left if bobbin winds high on right; move bracket to the right if bobbin winds high on left. When bracket is properly centred, thread will wind evenly across bobbin.

Bobbins can be wound while machine is sewing. Follow instructions on page 13 omitting item 4.

TO REPLACE BOBBIN

Hold the bobbin between the thumb and forefinger of the left hand, the thread drawing from right to left, as shown in Fig. 14.

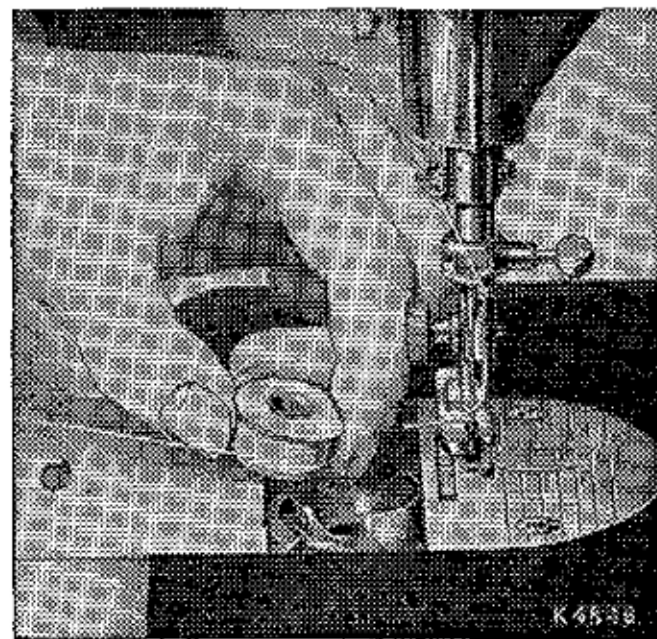

Fig. 14. Replacing the Bobbin.

Place the bobbin into the bobbin case and draw the thread into the slot 1, Fig. 15 in the bobbin case, as shown. Draw the thread backward between

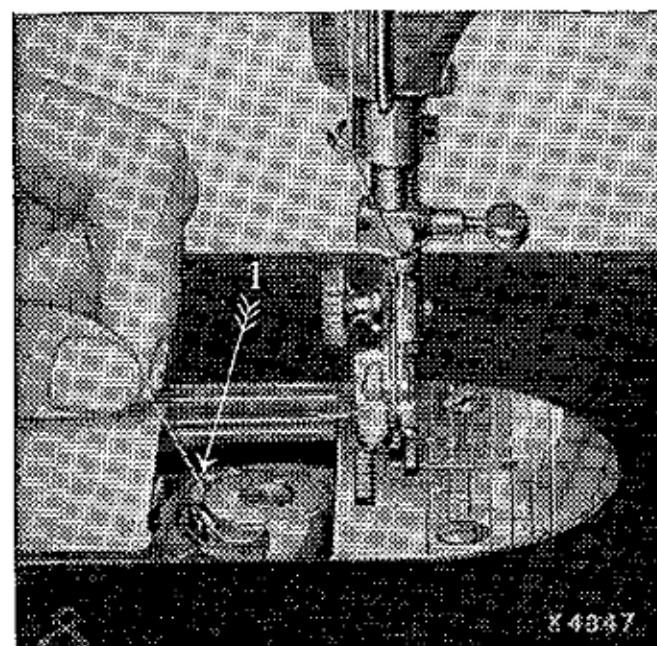

Fig. 15. Threading the Bobbin Case.

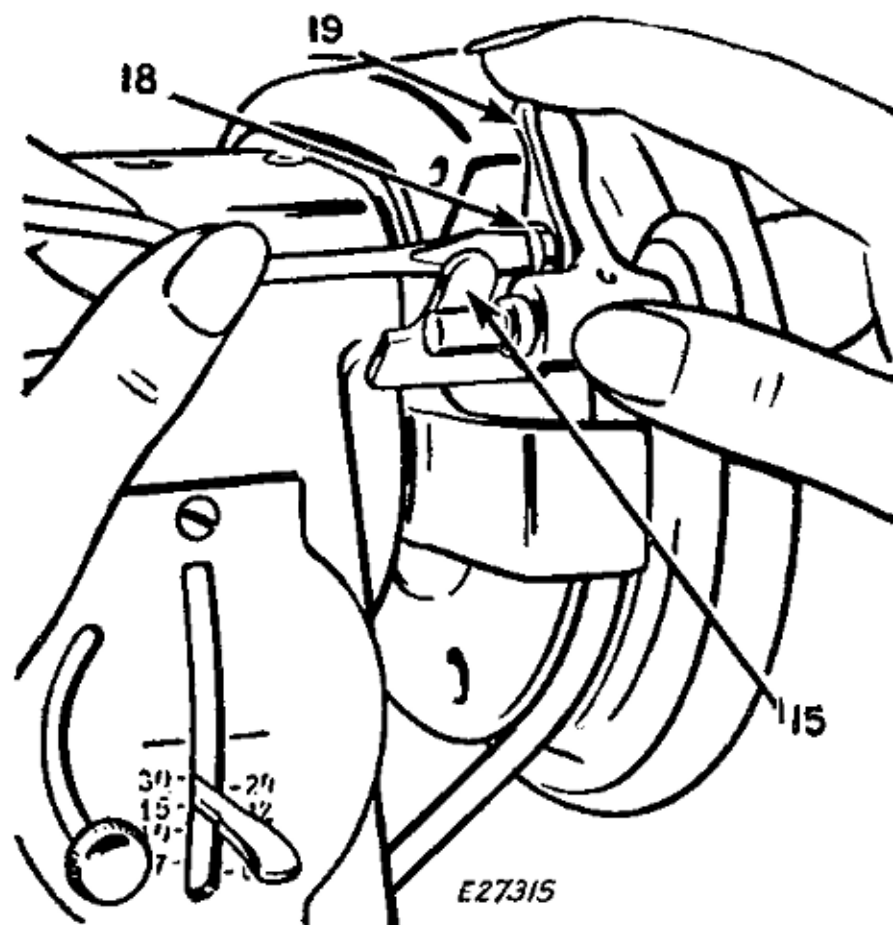

Fig. 13. Adjustment of Bobbin Winder.

the bobbin case and the tension spring until it reaches the notch 2, Fig. 16, then pull the thread toward the right, as shown

in Fig. 16. Close the slide, as shown in Fig. 17.

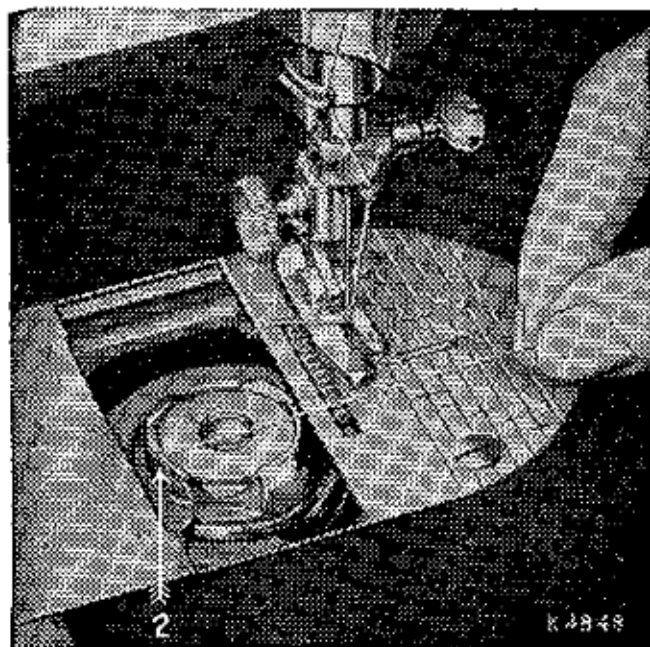

Fig. 16. Bobbin Case Threaded.

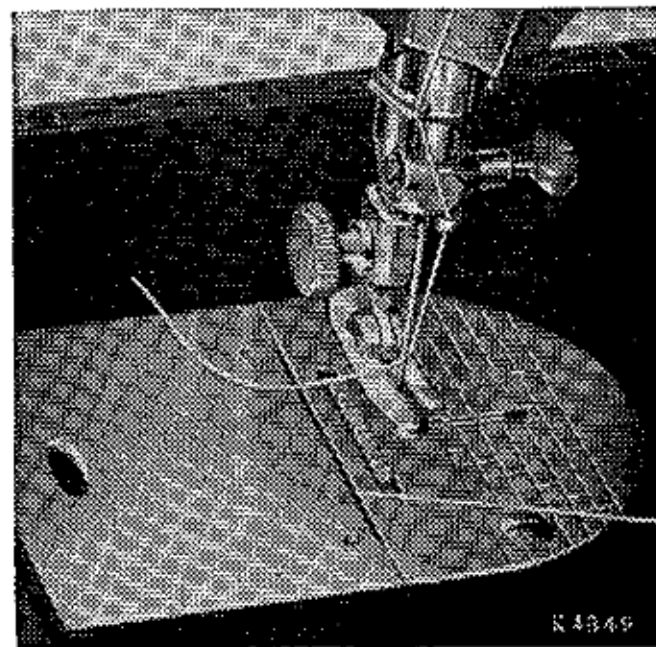

Fig. 17. Under Threading Completed.

TO PREPARE FOR SEWING

Have the thread take-up lever at its highest position, then, with the left

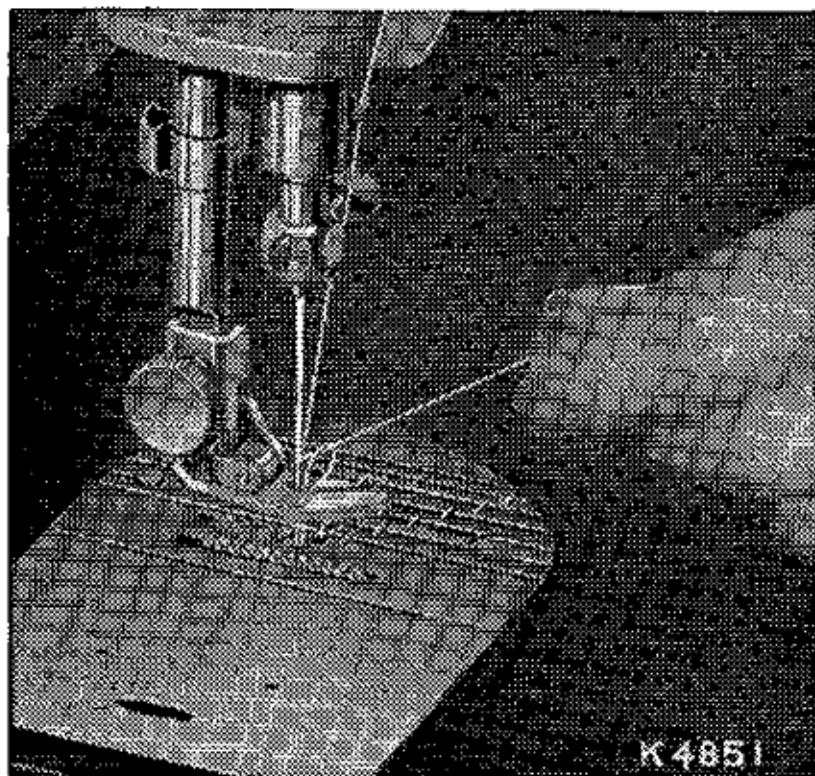

Fig. 18. Drawing Up the Under Thread.

hand, hold the end of the needle thread, leaving it slack from the hand to the needle. Turn the hand wheel over toward you until the needle moves down and up again to its highest position, thus catching the bobbin thread. Draw up the needle thread and the bobbin thread will come up with it through the hole in the throat plate as shown in Fig. 18.

Lay both threads back under the presser foot diagonally across the feed, to the right or left, depending upon which side of the needle the material is to be located so that when the presser foot is lowered, the threads will be firmly held between the feed and the presser foot.

TO START SEWING

See Fig. 19.

Be sure to have thread take-up lever 5, Fig. 10 in its highest position.

The throat plate has guide lines for seam width gauged from centre of needle hole, and cross lines for gauging square corners.

Place material beneath the presser foot G, turn the hand wheel to bring the point of the needle into the material, then lower the presser foot by means of presser bar lifter J, and start to sew.

Some materials, such as soft finished sheers, nylons, jerseys, tricots and other elastic and spongy textiles, require a slight amount of assistance in feeding during sewing operations.

However, too much pull will stretch the seam, create irregular stitching and bend the needle. Most materials require only guiding for best sewing results.

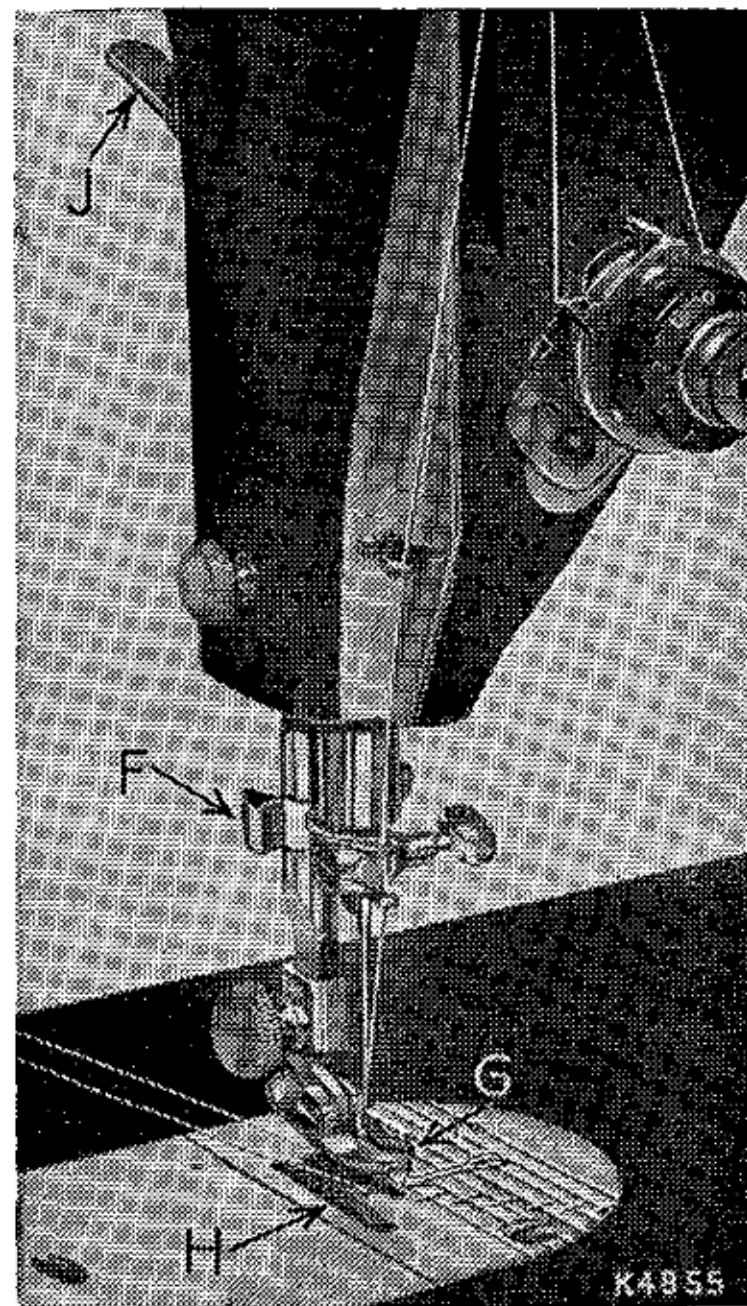

Fig. 19. To Start Sewing.

TO TURN A CORNER

Stop the machine when the needle eye, making its upward stroke, is still in the fabric. Raise the presser foot and turn the work as desired, using the needle as a pivot, then lower the presser foot.

BASTING

The longest stitch, No. 6 on the stitch indicator, is satisfactory for basting and is easily removed by clipping every sixth stitch and withdrawing the long continuous thread.

Machine basting is firmer and more even than that done by hand in addition to being much quicker.

TO SEW BIAS SEAMS

Use a short stitch and as light a tension as possible on the needle thread so that the thread is loose enough in the seam to allow the goods to stretch if necessary.

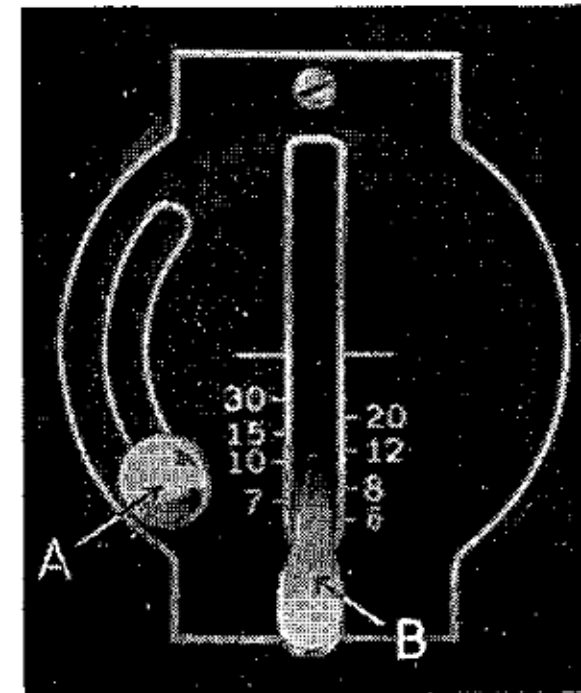

Fig. 20. To Regulate Stitch Length.

TO REMOVE THE WORK

Stop the machine with the thread take-up lever **5**, **Fig. 10** at its highest point. Raise the presser foot by means of presser bar lifter **J**, **Fig. 19**, draw the fabric back and to the left and sever the threads on thread cutter **F**, **Fig. 19**. Place ends of threads under presser foot.

CAUTION :

When the machine is not in use, raise the presser foot by means of presser bar lifter **J** to prevent injury to the presser foot **G** and the feed **H**, **Fig. 19**.

TO REGULATE LENGTH OF STITCH AND DIRECTION OF FEED. *See Fig. 20.*

The machine can be adjusted to make from 6 to 30 stitches to the inch, as indicated by the numerals on the stitch indicator plate.

Loosen screw **A** and lower it to the bottom of the slot, then move lever **B** until its top edge is level with the figure denoting the number of stitches desired per inch. Raise screw **A** as far as possible, and tighten it. Thus set, the machine will make the indicated number of stitches in a forward direction. If it is desired to reverse the direction of the stitching, raise lever **B** as far as possible, and the machine will make the same number of stitches in a backward direction.

TO REGULATE PRESSURE ON MATERIAL

For ordinary sewing, the pressure of the presser foot on the material seldom requires changing. Heavy materials require more pressure than light weight materials. The pressure should be only heavy enough to prevent the material from rising with the needle and to enable

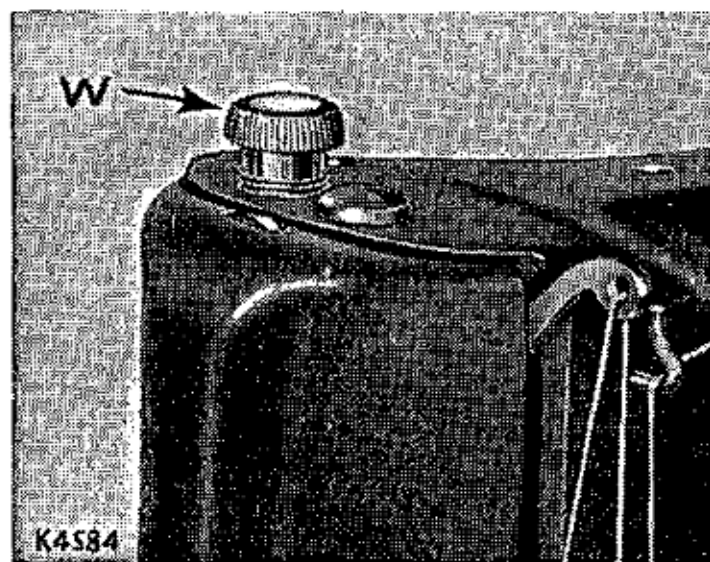

Fig. 21. Thumb Screw for Regulating Pressure on Presser Foot.

the feed to move the work along evenly. To increase the pressure, turn the thumb screw **W**, Fig. 21 clockwise or downward. To lighten the pressure, turn the thumb screw upward.

THREAD TENSIONS

For perfect stitching, the tension on the needle and bobbin threads must be heavy enough to pull the threads to the centre of the thickness of the material and make a firm stitch, as shown in Fig. 22.

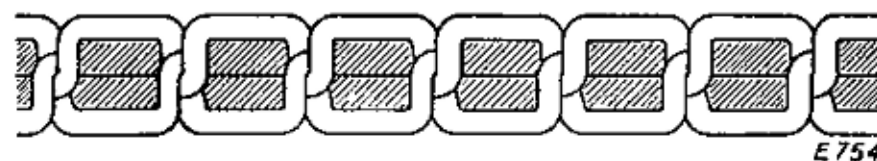

Fig. 22. Perfect Stitching.

If the needle thread lies straight along the top side of the material, the tension

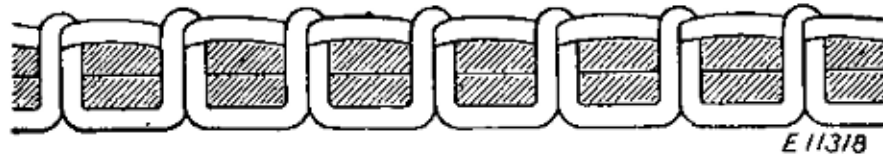

Fig. 23. Imperfect Stitching.

on the needle thread is too heavy or the tension on the bobbin thread is too light, as shown in **Fig. 23**.

If the bobbin thread lies straight along the underside of the material, the tension on the needle thread is too light or the tension on the bobbin thread is too heavy, as shown in **Fig. 24**.

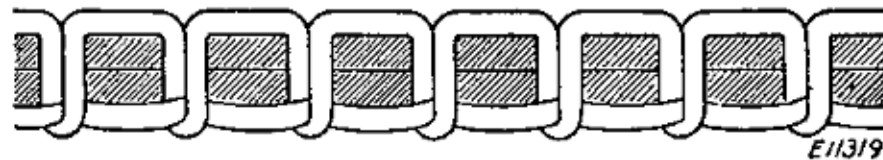

Fig. 24. Imperfect Stitching.

TO REGULATE NEEDLE THREAD TENSION

See Fig. 25.

The tension on the needle thread can be tested only when the presser foot is down.

The numerals "0" to "9" on dial B, indicate the different degrees of tension that can be obtained.

When the tension has been correctly set note the number at the indicator line C, so that this setting may be regained should the tension be altered for special work.

To increase tension, turn the thumb nut A gradually to the right (clockwise) until the required tension is obtained.

Each higher number denotes increased tension.

To decrease tension, turn the thumb nut A gradually to the left (counterclockwise) until the required tension is obtained. Each lower number denotes less tension.

The tension indicator C is marked with the signs + and —, which indicate the direction in which to turn the thumb nut A for more or less tension.

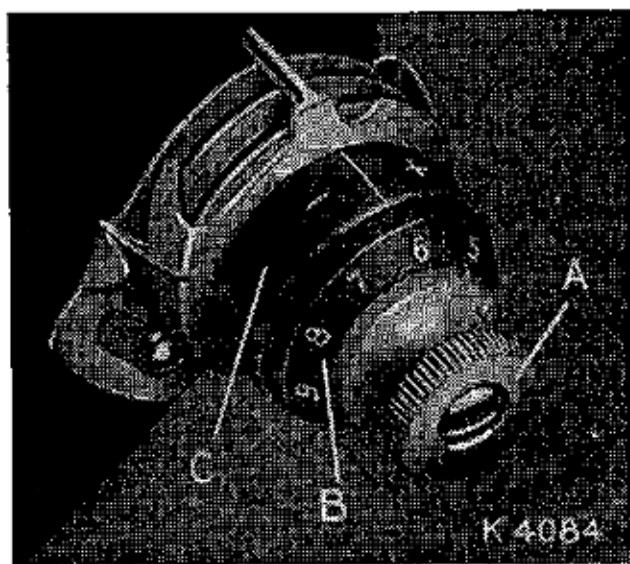

Fig. 25. To Regulate Needle Thread Tension.

TO REGULATE BOBBIN THREAD TENSION

The tension on the bobbin thread is regulated by screw F, Fig. 32, which is nearest the centre of the tension spring on the outside of the bobbin case. To increase the tension, turn screw F over to the right. To decrease the tension, turn this screw to the left.

When the tension on the bobbin thread has been once properly adjusted, it is seldom necessary to change it, as a correct stitch can usually be obtained by varying the tension on the needle thread.

DARNING (See Fig. 26).

Raise needle to its highest point, turn machine back on its hinges, unscrew knurled screw **A**, as far as it will go, and move crank **B** down so that the screw **A** will enter the upper hole **C**. The screw should then be securely tightened. The feed is now inactive and will not impede free movement of the work. Restore machine to its working position and raise the presser bar. Remove the presser foot and fit Spring Darning Foot No. 121094 but do not tighten the thumb screw. Stretch tightly the article to be repaired in an embroidery hoop and place below the needle by tilting the edge of the hoop. Then lower the presser bar by means of its lifter, and adjust the height of the darning foot to allow just sufficient space for the free movement of the work in hand. After adjustment, tighten the thumb screw securely. Now move the hoop backward and forward by the hands until the hole or damaged part is completely covered with stitching in one direction. Then turn the work and stitch across to complete the darn. After darning, reinsert and firmly tighten the screw **A** in the lower hole, and replace the presser foot for ordinary sewing.

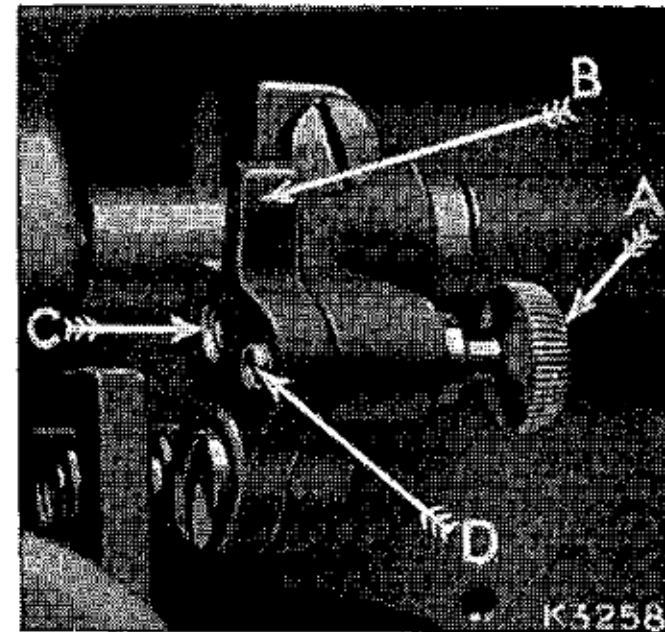

Fig. 26.

EMBROIDERY

For surface embroidery, remove the presser foot to give a clear view of the stitching. For lace embroidery, i.e. open work, remove the ordinary presser foot and fit Spring Foot No. 121094. For embroidery the feed should be lowered and the work handled as advised in the preceding paragraph.

SEWING SUGGESTIONS

Breaking of needles might be caused by

1. Improper size of needle for thread and material—See page 11.
2. Bent needle.
3. Pulling of material when stitching.
4. Needle striking improperly fastened presser foot or attachment.
5. Crossing thick seams with too small a needle.

Breaking of needle thread might be caused by :

1. A knot in thread.
2. Improper threading—See page 12.
3. Upper tension too tight—See pages 22 and 23.
4. Needle set incorrectly—See page 10.
5. Needle blunt or bent.
6. Thread too coarse for needle—See page 11.

7. Roughened hole in throat plate.

8. Improper arrangement of threads to start sewing—See page 18.

Breaking of bobbin thread might be caused by :

1. Improper threading of bobbin case—See page 15.
2. Bobbin thread tension too tight—See page 23.
3. Bobbin wound unevenly.

Skipping of stitches might be caused by :

1. Improper setting of needle—See page 10.
2. Needle blunt or bent.
3. Needle too small for thread—See page 11.
4. Needle rubbing presser foot.

PROTECTION AGAINST RUST DAMAGE

Lint and fluff, if not removed prior to storage will, during humid periods, absorb and hold moisture, and thus accelerate rust damage to highly polished thread handling and other exposed parts. The extent of rust damage would depend upon the length of time the machine remained in idle storage where there is no ventilation. Sudden drops in temperature will cause moisture to form on parts which, if not protected by a film of oil, would rust and damage while in storage.

Proper storage care suggests thorough brush-cleaning to remove all traces of lint and fluff, followed by swabbing of all the exposed parts in Figs. 28 and 29 with a lint-free brush saturated with SINGER Oil.



*SINGER Lint Brush may be purchased at
your local SINGER SEWING CENTRE.*

TO OIL MACHINE and STAND

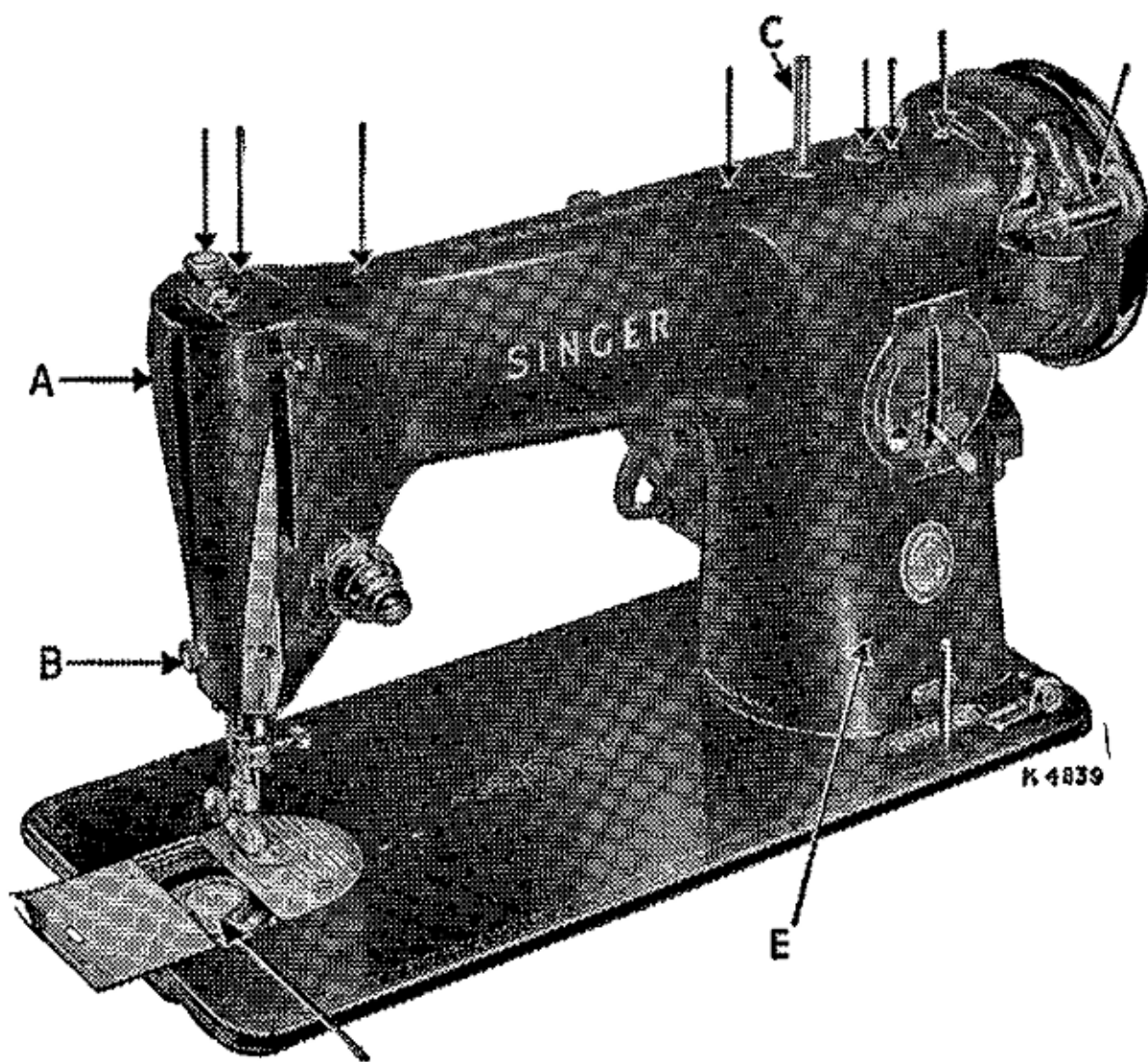
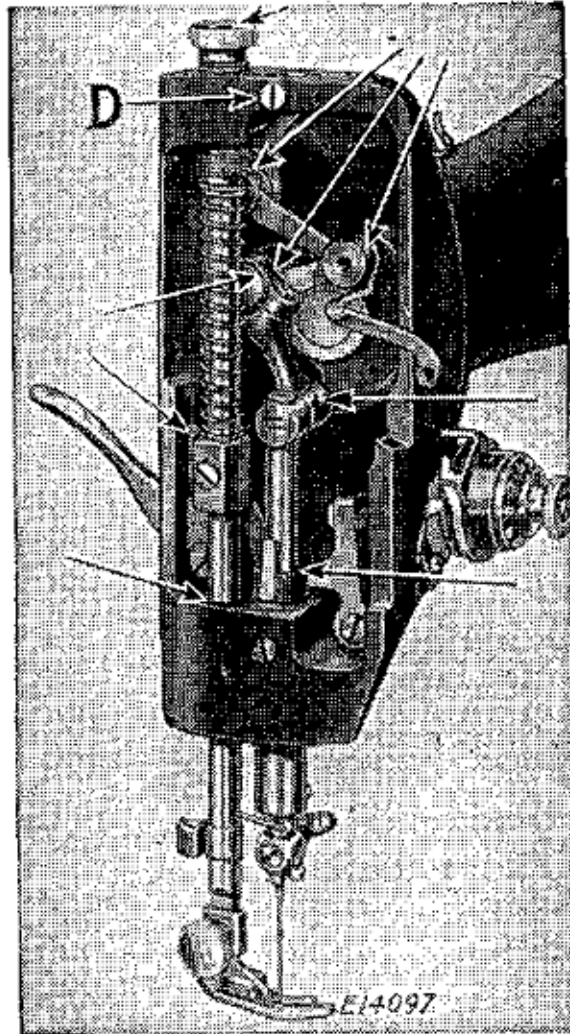

Fig. 27. Front View, Showing Oiling Points.

The Arm Spool Pin C is screwed for insertion in the left plugged hole and it is also provided with a screw driver slot. If the machine is used continuously, it should be oiled daily. If moderately used, an occasional oiling is sufficient. Apply one drop of oil to each of the places indicated in Figs. 27, 28, 29, 30 and 31 and carefully clean the machine to insure smooth and satisfactory performance. Oil holes are provided in the machine for bearings which cannot be directly reached.

Remove face plate A, Fig. 27, by taking out screw B and slipping plate over screw D, Fig. 28. After oiling replace face plate. Draw to the left the slide in the bed of the machine, as shown in Fig. 27, while the



*Fig. 28. Face Plate Removed,
Showing Oiling Points.*

thread take-up lever (5, Fig. 10) is at its highest position, and, after removing the lint and dust which may have accumulated (see instructions on page 26), apply one drop of oil to the sewing hook race in the bobbin case, as indicated by arrow "A" in Fig. 29, and a few drops to the oil hole "B" in Fig. 29. Then close the slide.

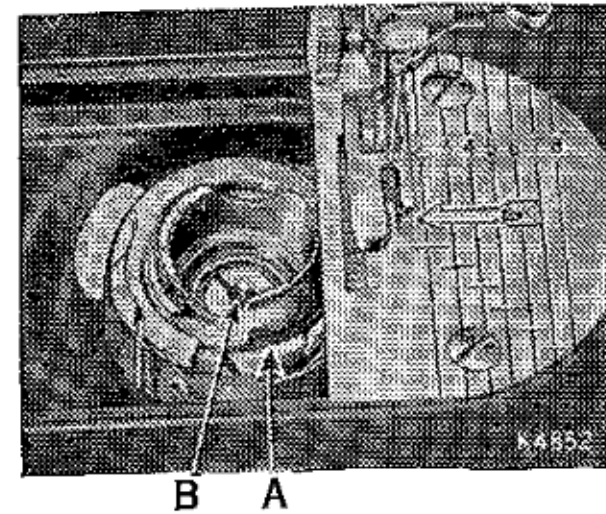

Fig. 29. Oiling the Sewing Hook.

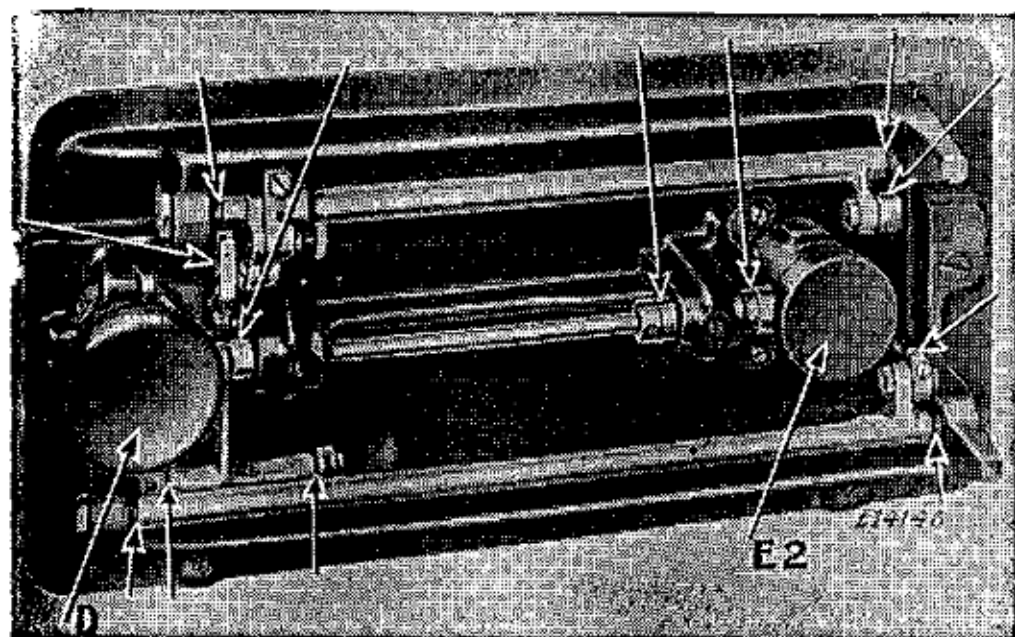

Fig. 30. Oiling Points in Bed of Machine.

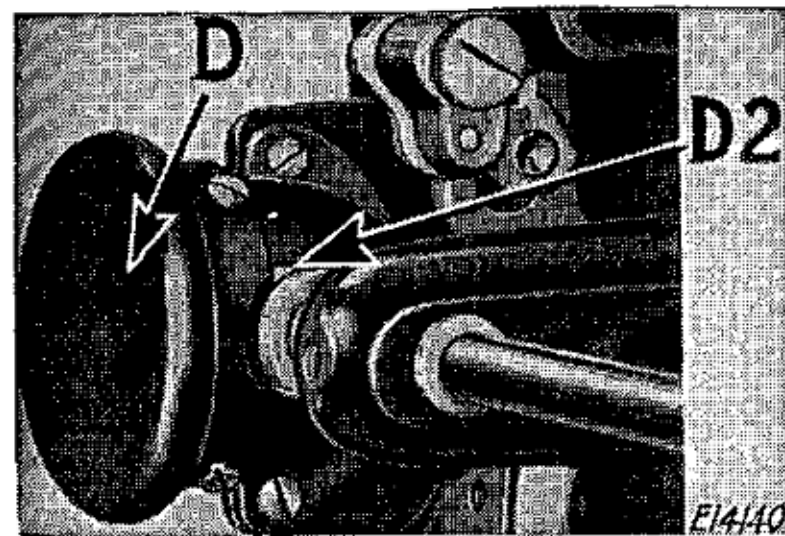

Fig. 31.

To oil the parts underneath the bed of the machine, turn the machine back on its hinges and apply oil to the oil holes and bearings indicated in **Fig. 30**. The gears concealed by the gear cover (**E2**, **Fig. 30**) are oiled through the oil hole (**E**, **Fig. 27**). The gears concealed by gear cover (**D**, **Fig. 30**) are oiled through the space just above this cover, as indicated by arrow (**D2**, **Fig. 31**). After oiling at **D2**, rotate the hand wheel toward you to distribute the oil on these gears. To oil the stand, apply a drop of oil to the centres upon which the treadle works, and to the lower end of the pitman rod. Run the machine rapidly for a few minutes so that the oil may reach the bearings. **Neglect to oil the machine will shorten its life and cause you trouble and annoyance. Always use SINGER* oil. Inferior oil clogs the bearings, prevents efficient working, and causes rapid wear of the mechanism.**

TO CLEAN STITCH FORMING MECHANISM

After considerable use, the stitch forming mechanism may become clogged with lint and this may interfere with the perfect operation of the machine.

Occasionally remove the bobbin case according to the following instructions, and remove any lint, etc., which has accumulated.

TO REMOVE BOBBIN CASE

See Fig. 32.

The bobbin case may be easily removed without taking off the throat plate, although for the purpose of illustration the throat plate and feed dog are shown broken away.

Remove bobbin from the bobbin case. Turn hand wheel over toward you until the end of hook ring E is toward the

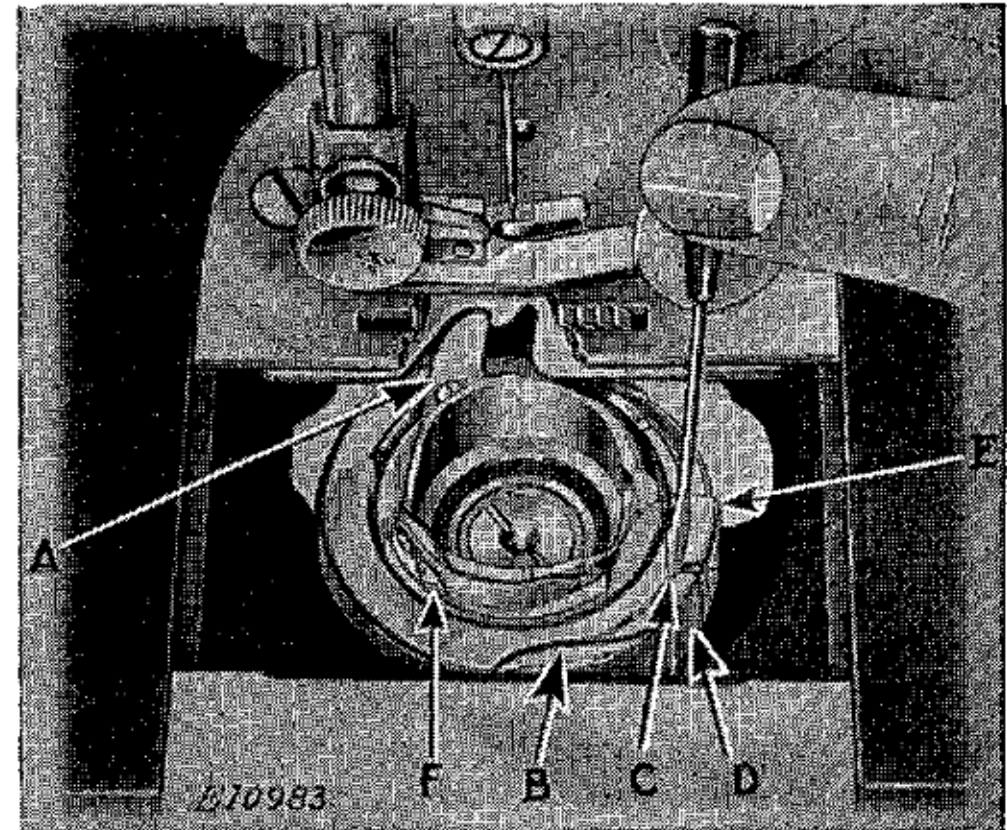

*Fig. 32. Bobbin Case in Position.
(Throat Plate broken away to show correct location of Finger A).*

front of machine, as shown. Insert the blade of the small screw driver into slot C between the ring and the edge of spring, as shown. With a downward pressure,

give the screwdriver one half turn to the right so that it will drop into the slot and unlock the spring.

With the right hand hold the hand wheel to prevent its turning and, with the left, place the screwdriver against the edge of the slot in the ring and push it around in the direction opposite to the hook rotation until the circular cut-out **B** is opposite the spring **D**. The ring and bobbin case may then be lifted out.

TO REPLACE BOBBIN CASE

See Fig. 32.

When replacing the parts, first place the bobbin case into position with the finger **A** in the opening in the plate under the feed dog, as shown. Turn the bobbin case back and forth slightly to make sure that it is properly seated, then place the hook ring **E** in position with the cut-out **B** opposite the spring **D**. Press the ring into place and turn it in the direction of hook rotation until the spring locks it in position. Then replace the bobbin.

**Free instruction for using the machine is gladly given at any
SINGER SEWING CENTRE**

**INSTRUCTIONS
FOR USING
ATTACHMENTS**

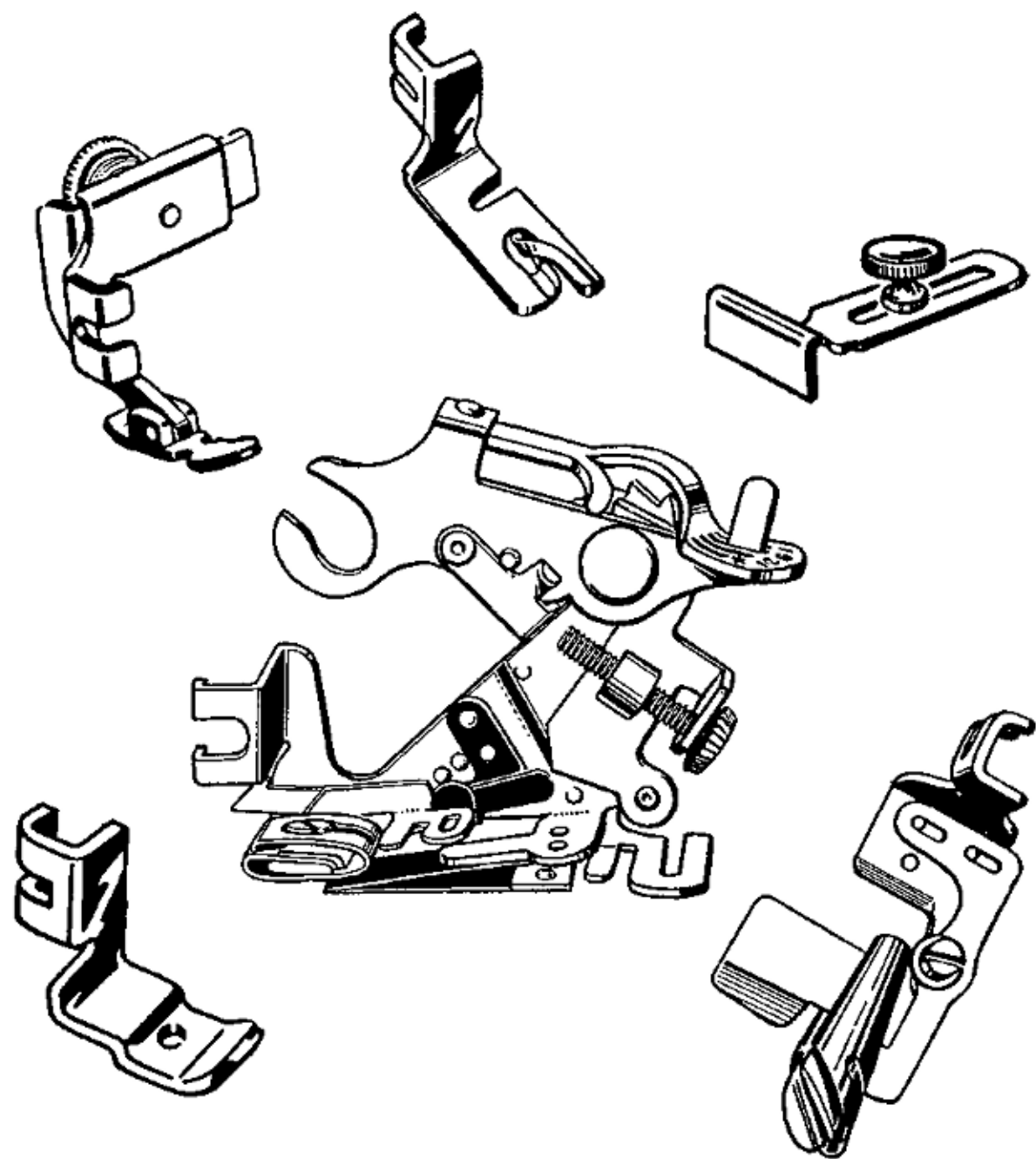

THE FOOT HEMMER

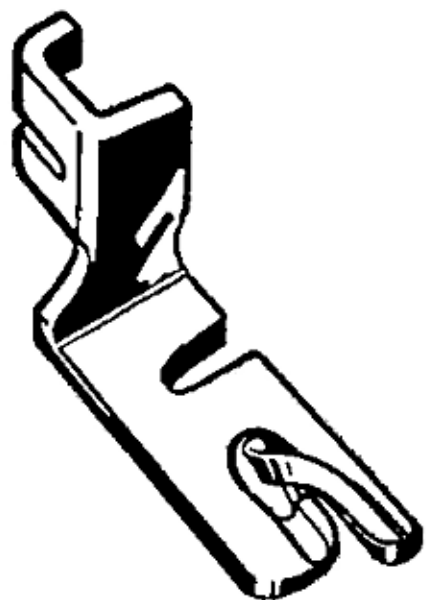

The foot hemmer forms and stitches a perfectly turned hem without basting or pressing. It is attached to the machine in place of the presser foot.

Applications

Fine hems
Edging ruffles
Sheer seams

Hemming with lace
Lace insertion
Lingerie finishes

Hemming

- Form a double $\frac{1}{8}$ " fold at the very edge of the fabric.
- Crease this fold for about 2".
- Draw the needle and bobbin threads under the hemmer.

- Place the creased hem edge under the foot and take several stitches through the fold.
- Grasp the thread ends and the single fold in front of the hemmer and lift the single fold into the hemmer scroll.

Soft fabrics will enter the scroll best with the foot down, firm crisp fabrics with the foot raised.

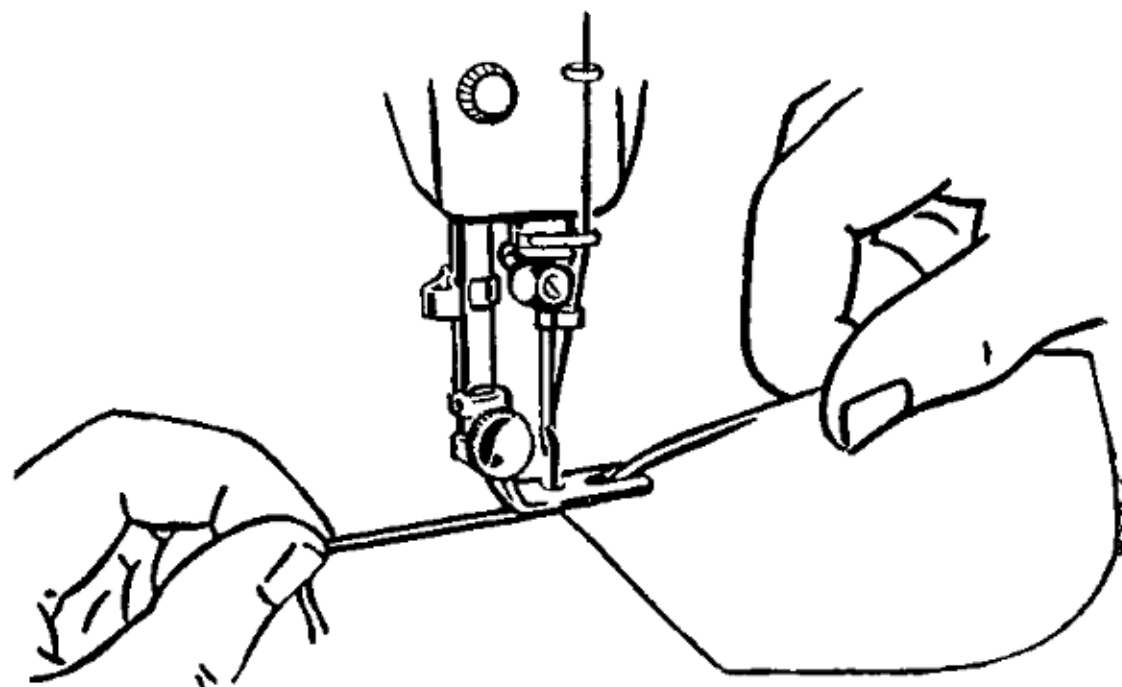

- Stitch slowly for several inches until hem is well started. Hold thread ends in back of foot with the left hand and guide the raw fabric edge into the mouth of the scroll with the right hand.

Even feeding is essential to good hemming. The same width of fabric must be kept in the scroll of the hemmer at all times.

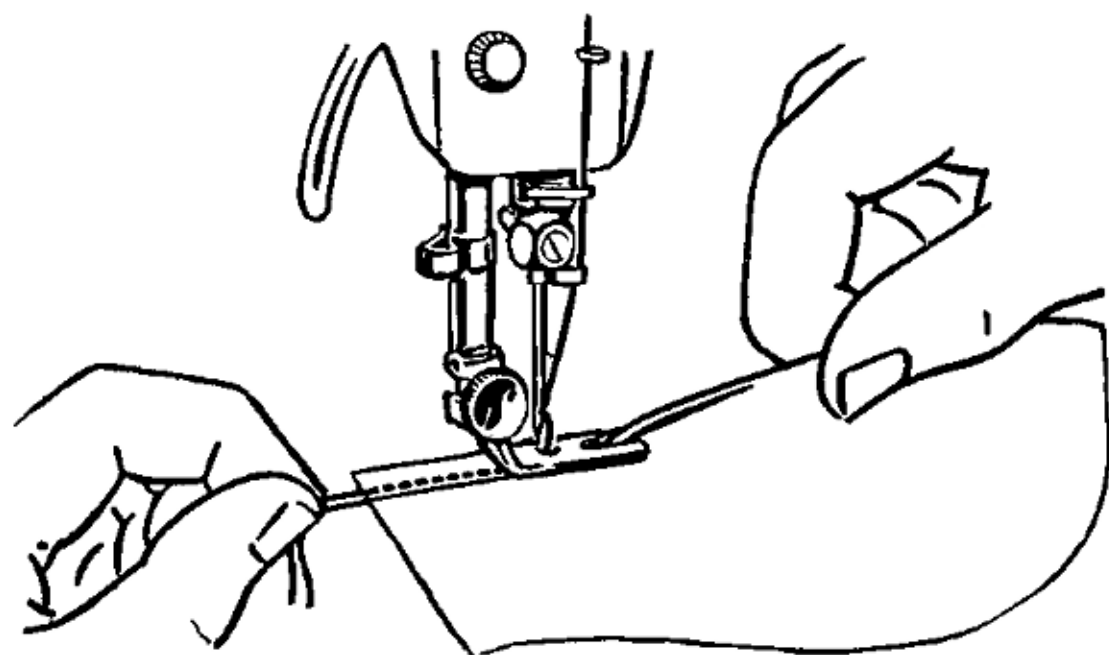

Hemmed Seams

Hemmed seams are often substituted for French seams where a fine narrow seam is appropriate.

- Allow a scant $\frac{1}{4}$ " seam allowance.
- With right sides of the fabric together, place the upper layer a scant $\frac{1}{8}$ " to the left of the lower layer.
- Insert the two fabric edges into the hemmer and proceed as for a plain hem.

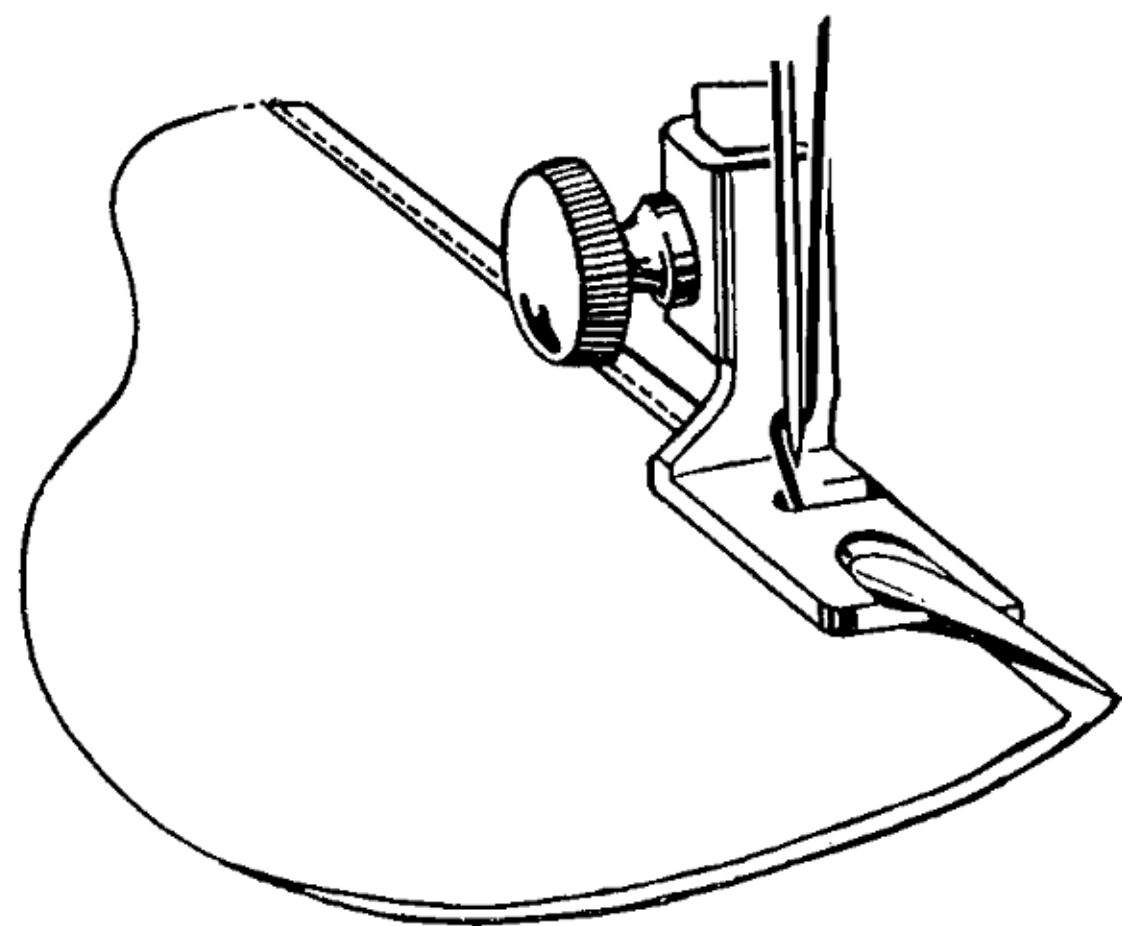

Hemming With Lace

Most of the popular kinds of lace edging and insertion can be applied with the foot hemmer. It is an excellent way to trim children's clothes and to finish lingerie hems.

Lace Applied Over Hem

- Fold and start hem in usual way.
- Starting about 1 inch down from end of lace, place selvage under the needle, then lower the needle to hold lace firmly.
- Raise hemmer foot slightly and slip lace under back part of foot.
- Stitch slowly, guiding fabric with right hand and lace with left hand. Take care not to stretch the lace.

Lace Applied Under Hem

When using lace underneath the fold of a hem, the procedure is the same as when making a hemmed seam (page 39). Slip the lace in from the left as you would the second piece of fabric.

This method is used where a neat finish is desired on both sides of the material.

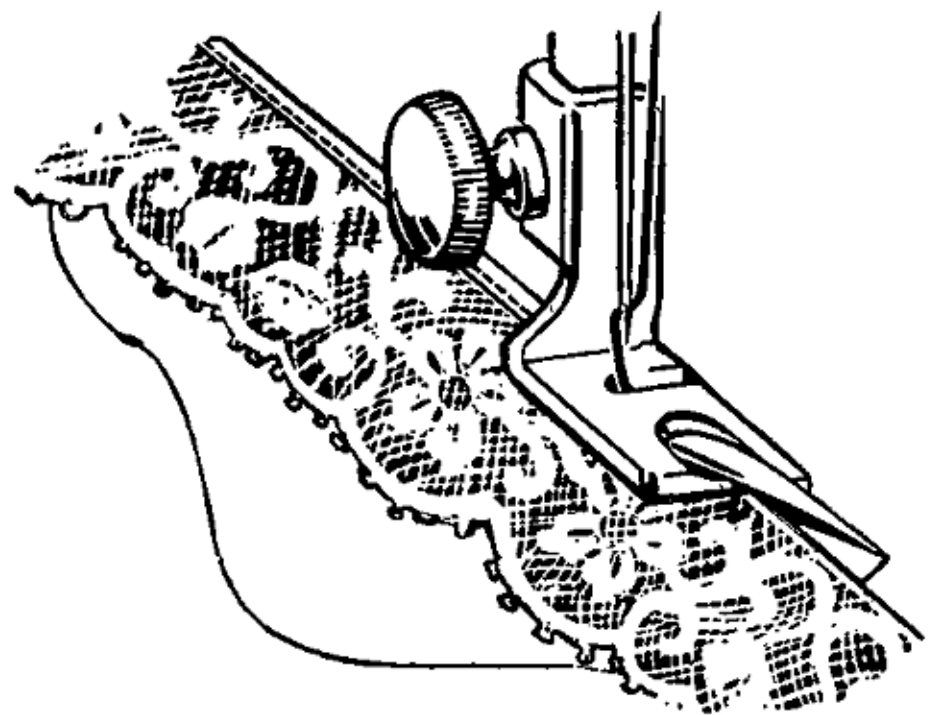
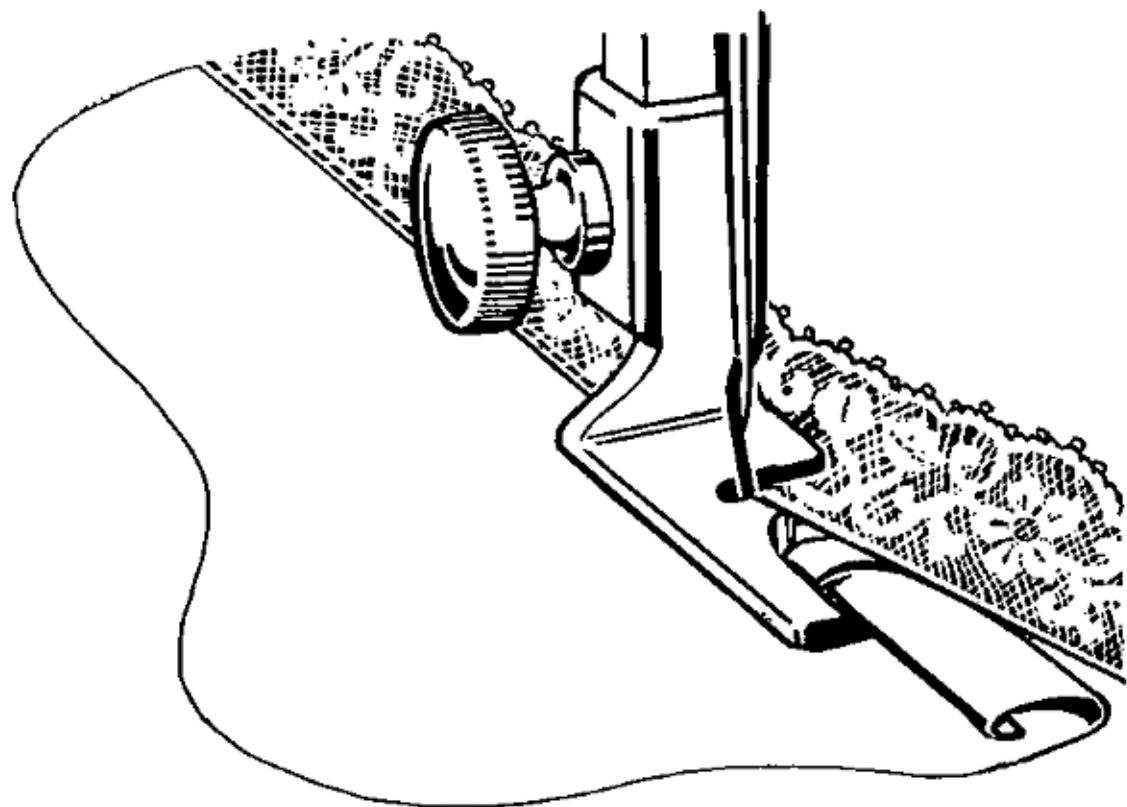

THE BINDER

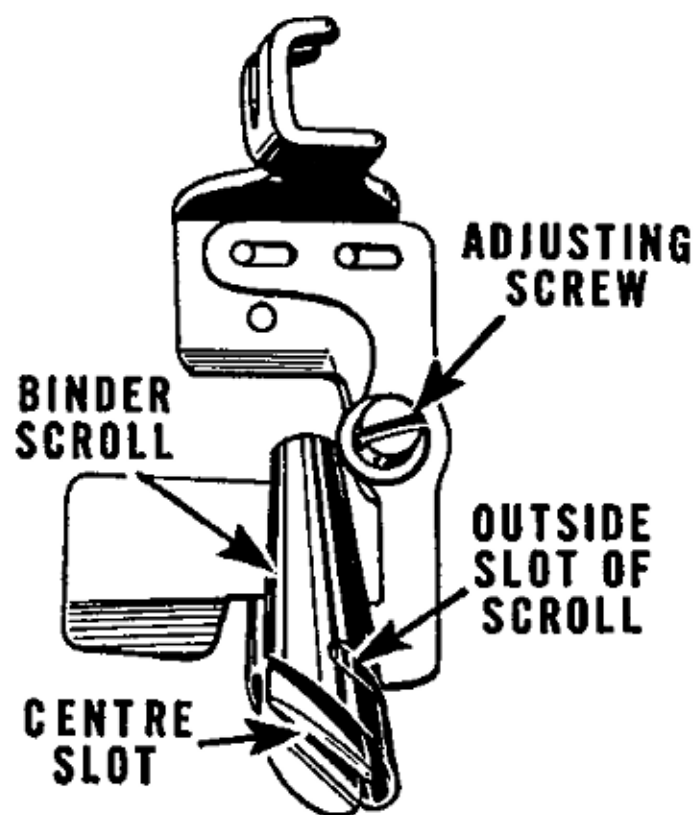

The binder is used to apply commercial binding as well as self-fabric bias to an unfinished edge.

This colourful trim is attractive when applied to children's wear, aprons and fabric furnishings. It is a practical finish for seam edges that ravel and for making bound seams.

Inserting the Binding

Pre-folded commercial bias binding is inserted from the right into the outside slot of the binder scroll.

- Cut the binding diagonally to form a long point.
- Insert the pointed end into the slot and pull through the scroll until the evenly folded edges are under the needle.

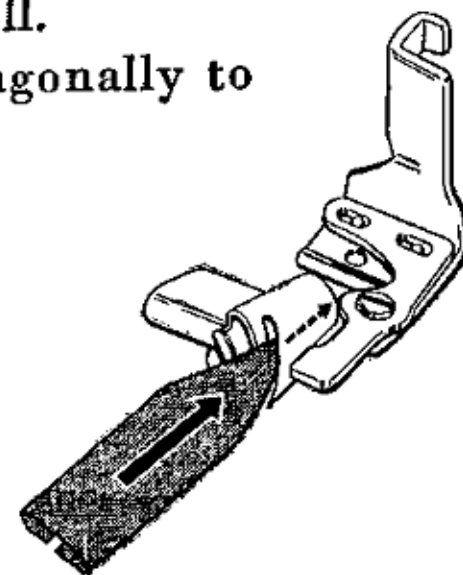

Self-fabric bias binding should be cut $\frac{15}{16}$ " wide on the true bias.

- Insert the unfolded binding directly into the two folds at the end of the scroll and draw it back under the needle.

As the binding passes through the scroll the raw edges are turned in.

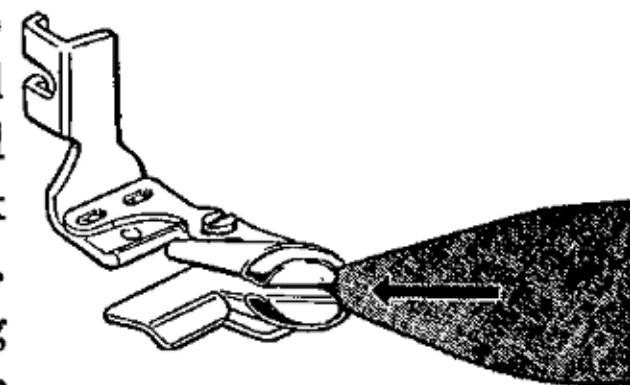

Adjustment and Operation of the Binder

The edge to be bound is guided into the centre of the scroll. Stitching is positioned close to the edge of the binding by adjusting the scroll portion of the attachment.

- Loosen the adjusting screw and move the scroll to the right to bring the stitching closer to the binding edge. For a wider adjustment, move the scroll to the left.

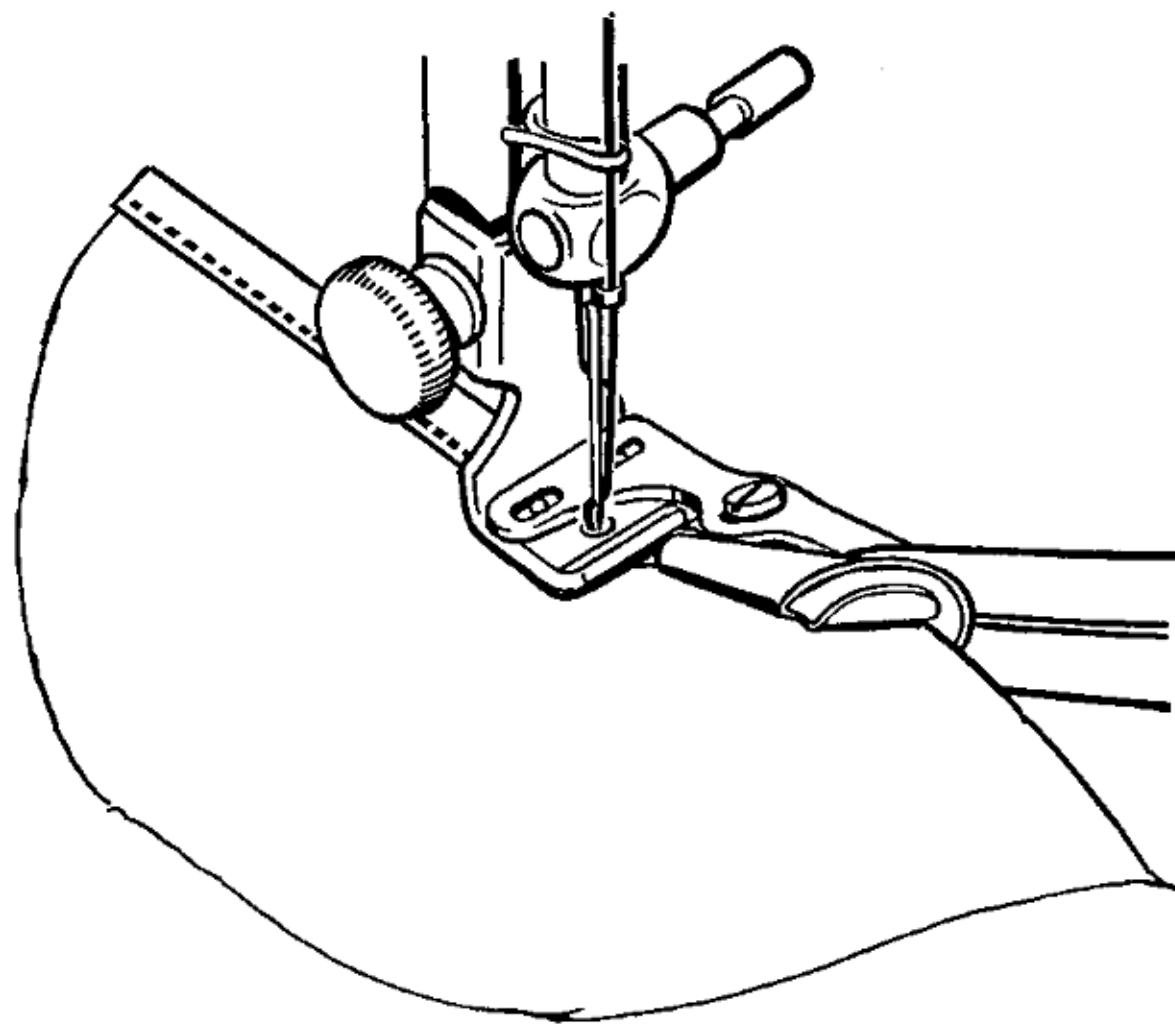
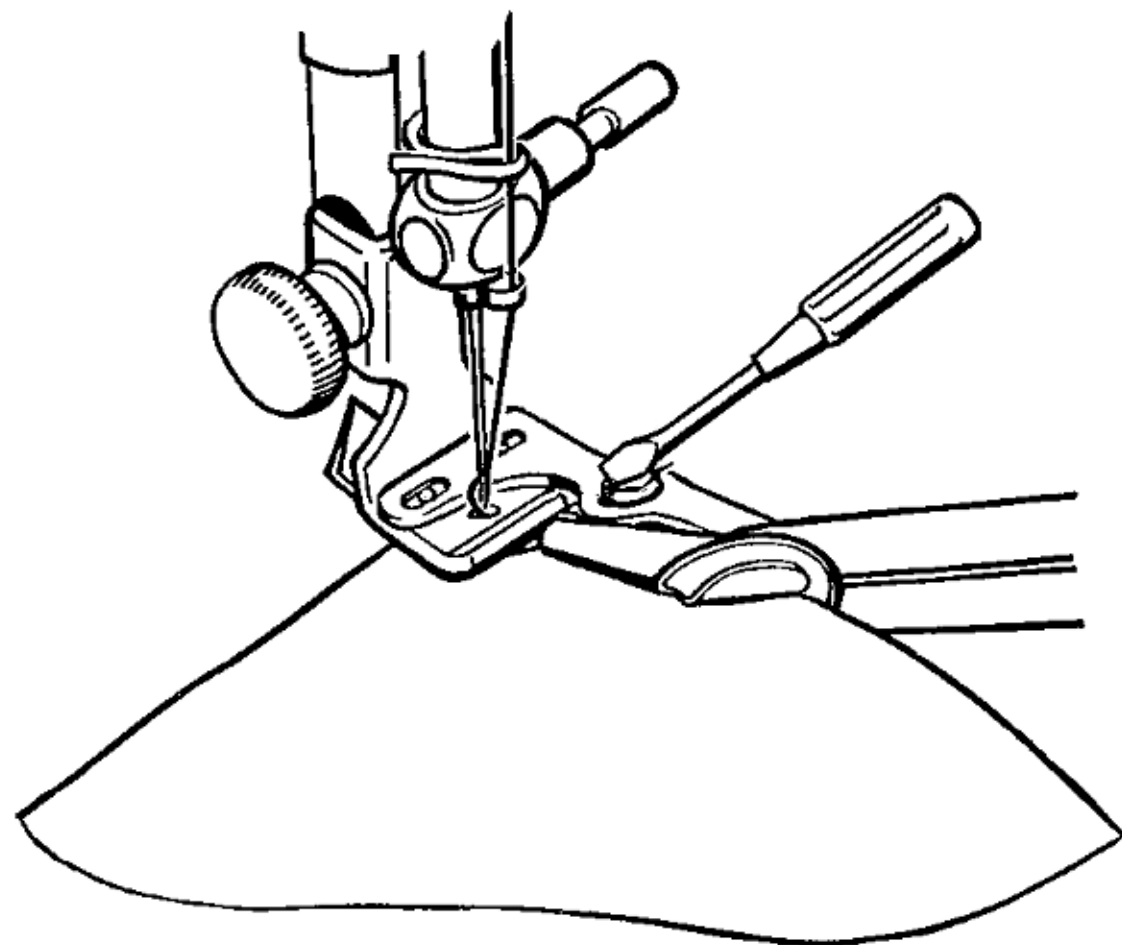

Be sure that the screw is well tightened after making an adjustment.

Never pull the binding as it feeds through the scroll. Allow the attachment to do the work. Merely guide the edge to be bound well into the centre of the scroll as you stitch.

Binding Curved Edges

Curved edges can be bound as easily as straight edges, but require slightly different fabric handling.

Inside Curves

Inside curves are straightened as they are fed into the binder. If the fabric is soft and has a tendency to stretch reinforce the edge with a single row of stitching before binding.

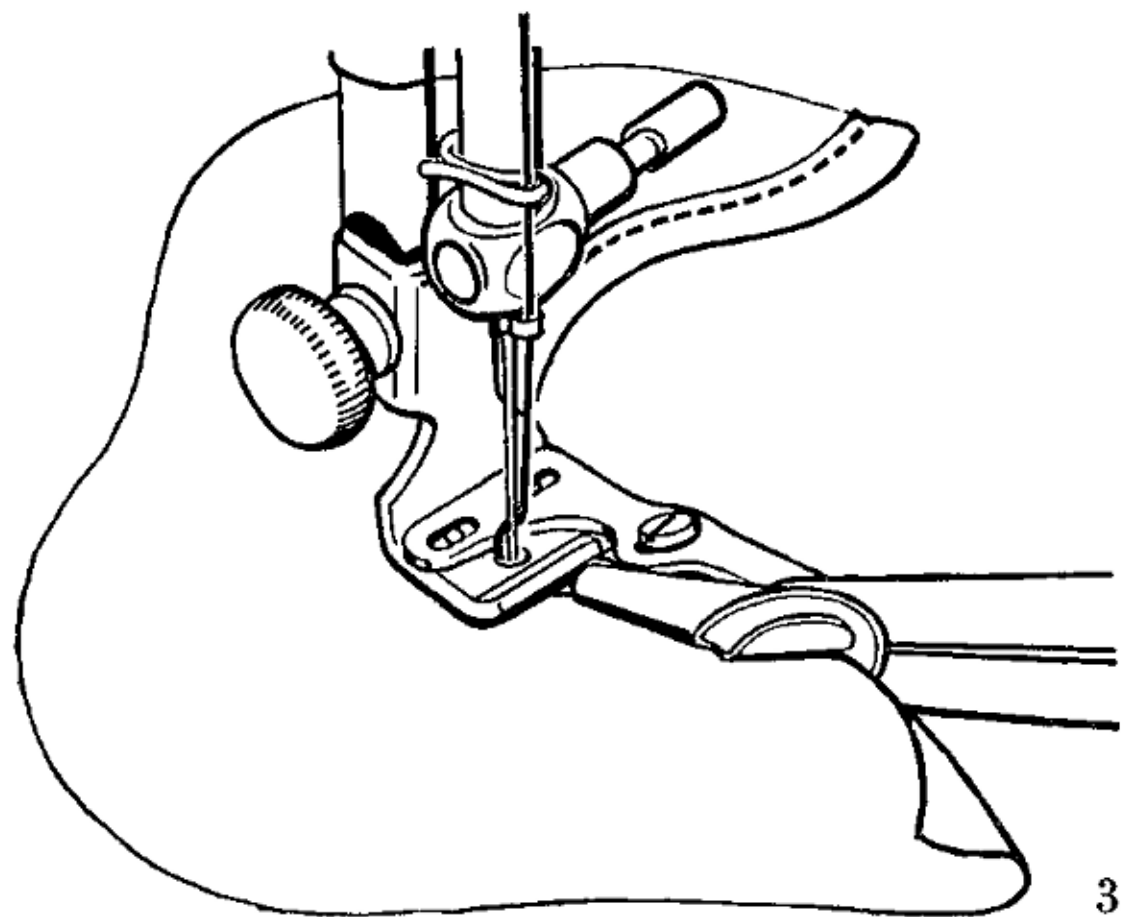

Outside Curves

Outside curves tend to lead away from the centre slot of the scroll and should be guided so that a full seam width is taken at the needle point. Do not attempt to pull or straighten the fabric into the full length of the scroll.

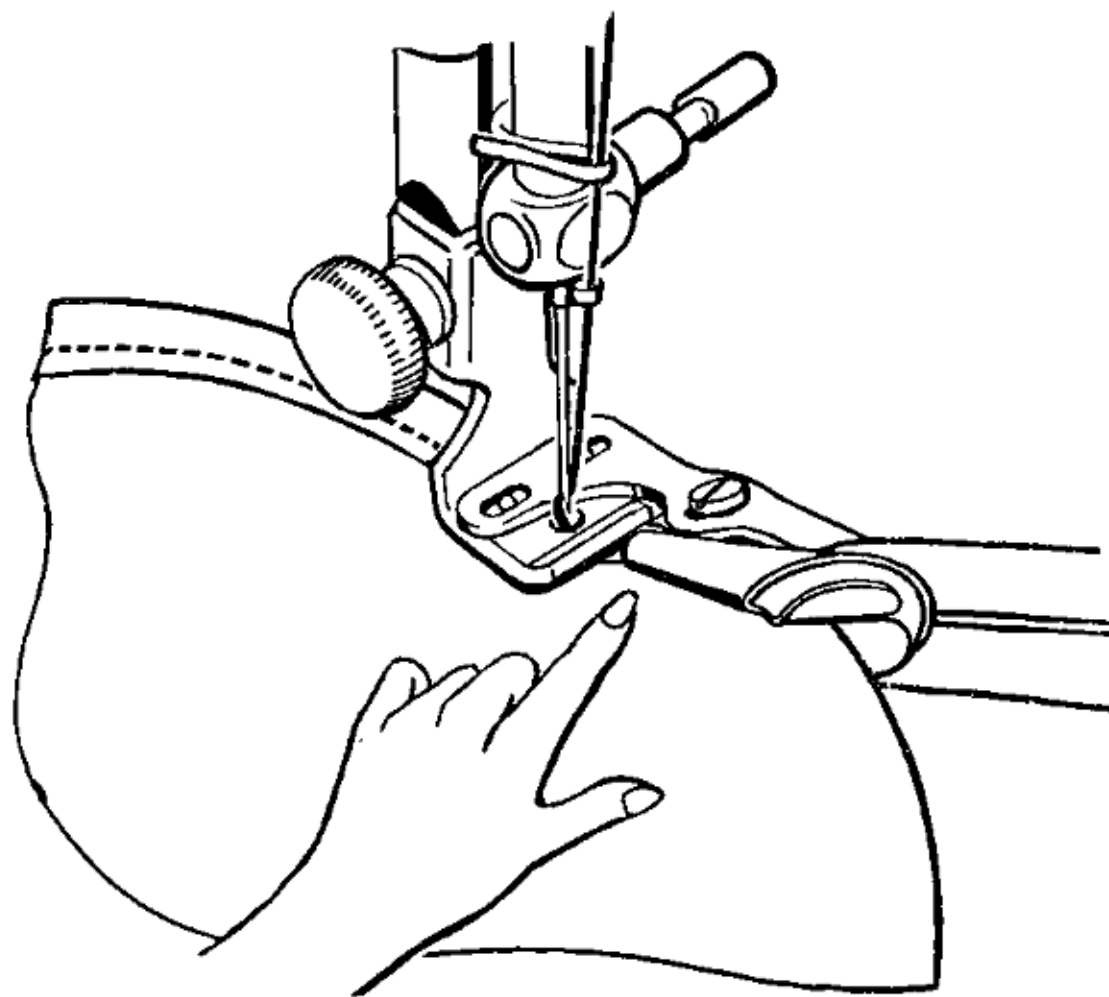

THE GATHERING FOOT

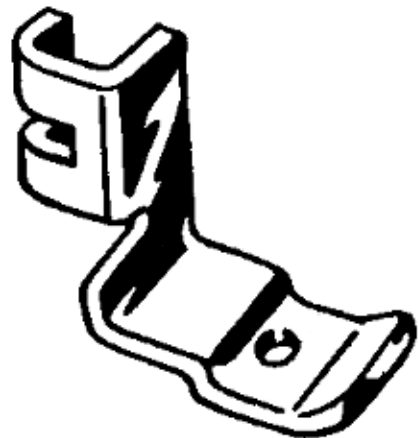

Single or multiple rows of shirring can be quickly and expertly placed with the gathering foot. Evenly spaced shirring is insured as this foot is designed to lock fullness into every stitch.

Applications

Plain shirring

Waffle shirring

Elastic shirring

Machine smocking

Shirring

Shirring is usually done on the crosswise grain of the fabric. Soft fabrics lend themselves to shirring better than firm fabrics.

The amount of fullness is very simply controlled by stitch length and degree of tension.

A long stitch produces more fullness than a short stitch. Balanced tensions are always required, but heavy tensions, both upper and lower, produce more fullness than light tensions.

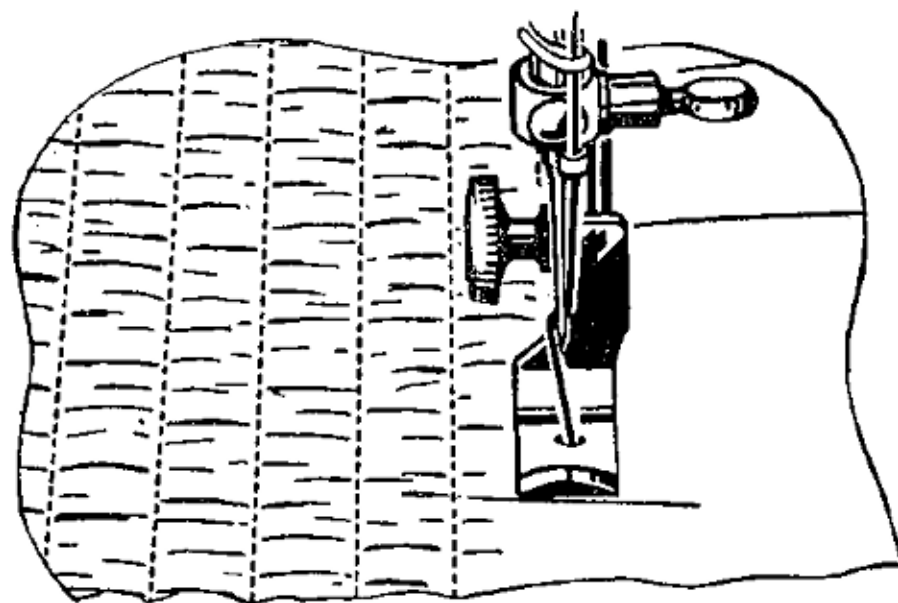

Many lovely effects are accomplished with simple rows of evenly spaced shirring. A yoke section, insert or trimming band of self-fabric affords an interesting contrast of texture when stitched with the gathering foot in rows $\frac{1}{4}$ " apart.

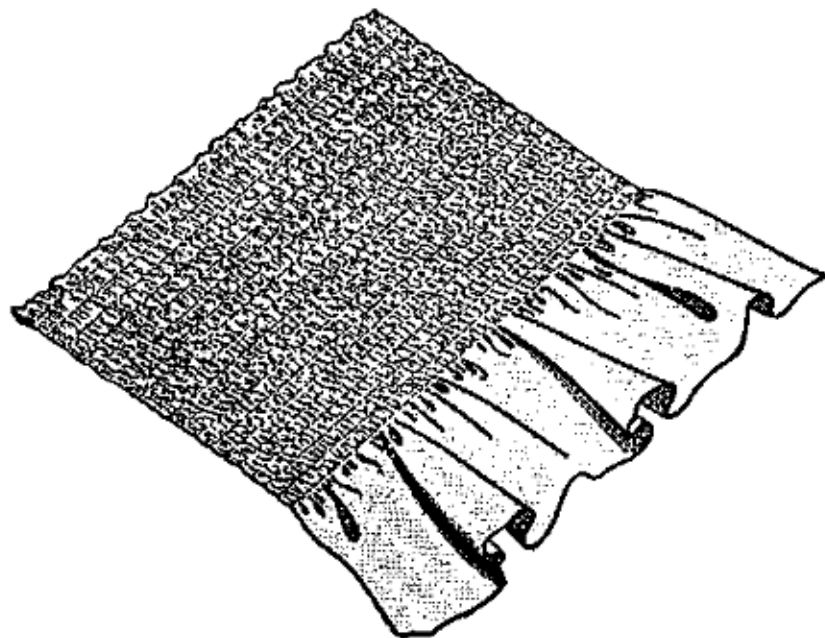

THE RUFFLER

Occasionally apply a drop of oil to parts in movable contact.

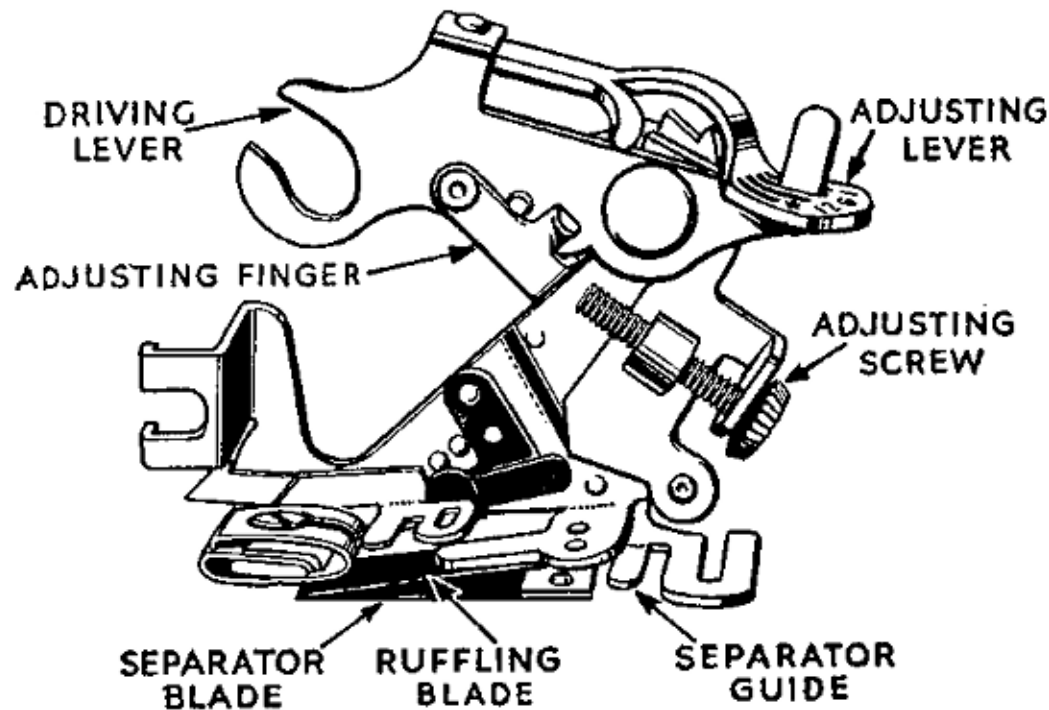

This attachment offers a simple and effective way to make gathered and pleated ruffles.

Ruffles may be made separately or made and applied at the same time.

The ruffler is attached to the machine in place of the presser foot.

Adjusting Points

1. The adjusting lever sets the ruffler for gathers or pleats. The number 1 space setting is for gathers, and places fullness at every stitch. Numbers 6 and 12 are space settings for pleats, spacing them either 6 or 12 stitches apart. The star is for plain stitching, and is used when grouping gathers or pleats.

2. The adjusting finger is used only for pleating and affects the width of the pleat. It is thrown out of action by bringing it out of contact with the adjusting screw located at the right of the ruffler.

3. The adjusting screw regulates the fullness of gathers or pleats. When turned in (clockwise) to its limit with the adjusting finger in place, the attachment is set for its deepest pleat. When turned out (anti-clockwise) to its limit and the adjusting finger out of action, the ruffler gives only a hint of fullness.

Activating Parts

The ruffling blade and the separator blade are of blue steel and hold the material to be gathered between them.

The ruffling blade forms the gathers or pleats by carrying the fabric to the needle according to the spacing and fullness to which the ruffler is adjusted. The separator guide is slotted to guide seam edges evenly and to separate the ruffle strip from the material to which the ruffle is attached.

Preparation

Raise the needle to its highest point.

Locate the attachment on the machine in place of the regular presser foot, and at the same time fit the fork of the driving lever over the needle clamp screw. Make sure both the presser bar screw and the needle clamp screw are tightened securely.

Gathering

- Set adjusting lever on No. 1 setting.
- Throw adjusting finger out of action.
- Turn adjusting screw for amount of fullness desired.

The attachment is set for maximum fullness by turning adjusting screw in (clockwise) as far as possible; for less fullness, turn adjusting screw out (anti-clockwise).

- Set stitch length to space the fullness. A short stitch gives more fullness than a long stitch.

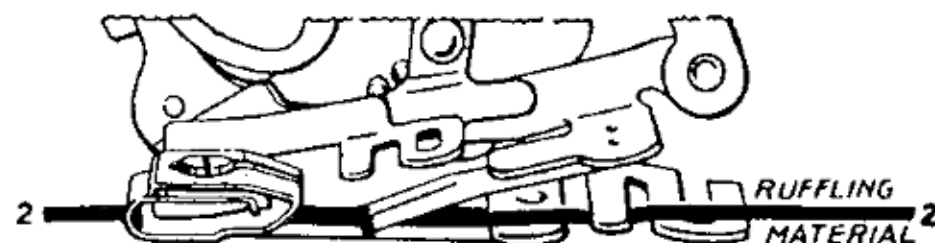

- Insert material to be gathered between the blue blades and through the first separator guide.
- Lower presser bar and stitch. Always test the stitch length and ruffler setting on a scrap of self fabric before proceeding with the actual work.

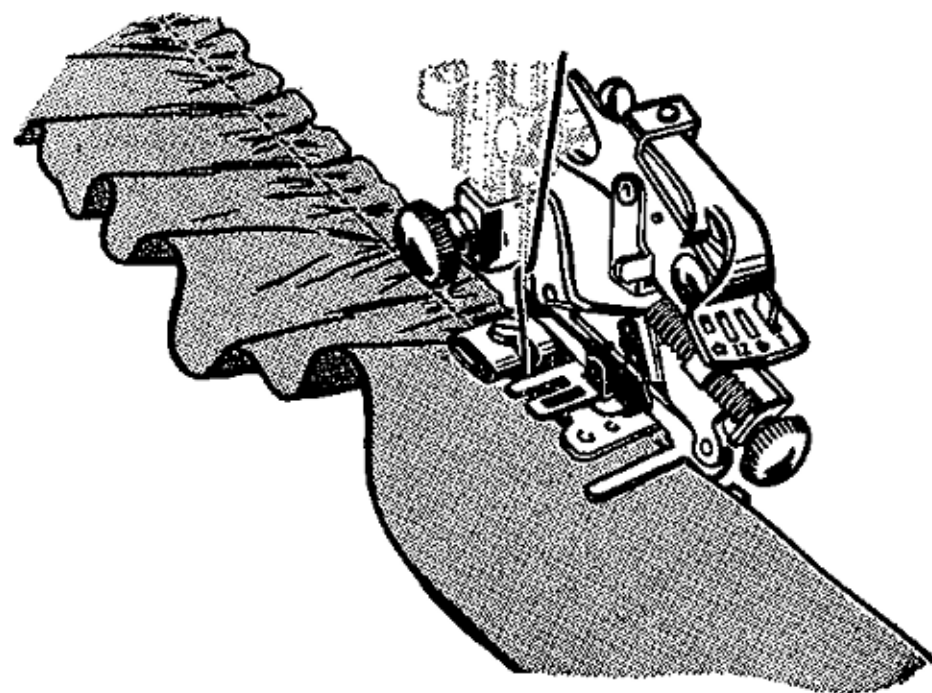

Forming and Attaching a Ruffle in one operation—

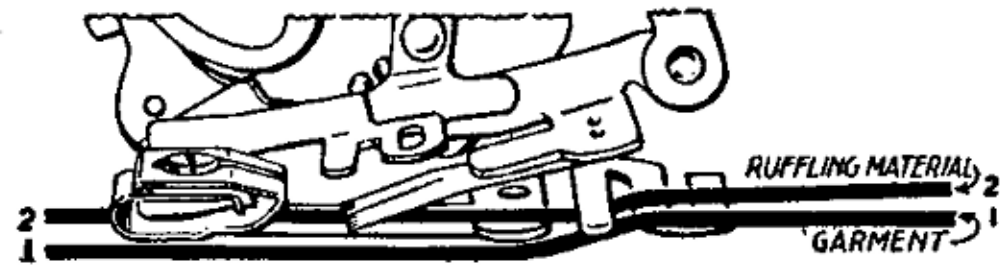

- Place ruffle strip between the two blue blades and through the first separator guide.
- Place fabric to which ruffle is to be attached between the separator blade and the feed of the machine.

Right sides of the fabric are placed together when the seam is to fall to the inside.

- Proceed as for plain gathering.

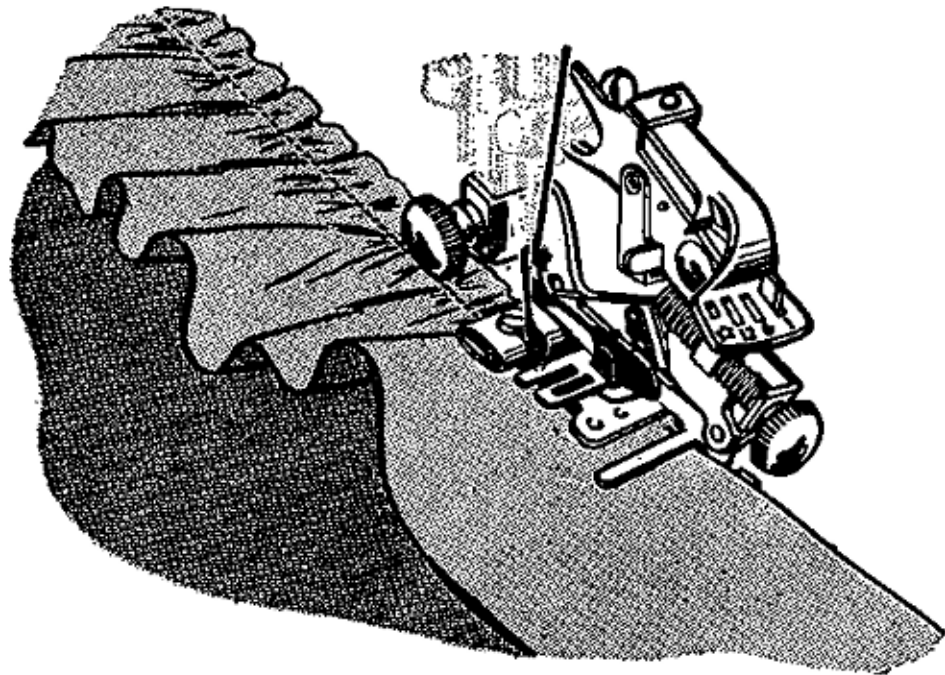

Pleating

- Move adjusting lever to space setting desired for pleats of either 6 or 12 stitches apart.
- Activate adjusting finger.
- For deepest pleat, turn adjusting screw in (clockwise) to its maximum. For shallower pleats, turn adjusting screw out (anti-clockwise).
- Set stitch length. A short stitch places pleats close together. A longer stitch separates the pleats for a greater distance.

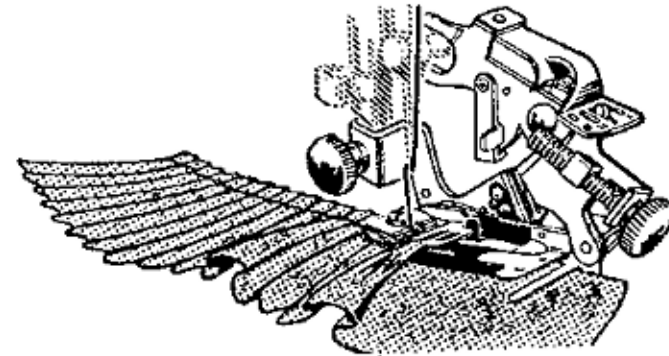

- Insert fabric to be pleated between the blue blades and through the separator guide.
- Lower presser bar and stitch.

Group Pleating

By using the star setting (plain stitching) alternately with the 6 or 12 setting, pleats are formed in groups. Even spacing between groups is easily accomplished by counting the number of stitches.

THE SEAM GUIDE

The seam guide is adjustable for spacing stitching at any distance between $\frac{1}{8}$ " and $1\frac{3}{8}$ " from a fabric edge. It is used in connection with the presser foot.

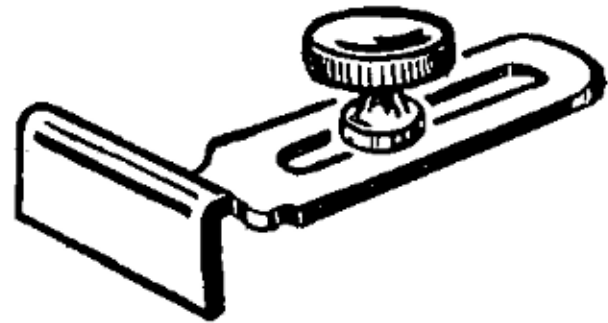

Applications

Seams Stay stitching
Top stitching—single and multiple rows

- Attach the guide to the machine with the thumb screw in either of the threaded holes at the right of the needle.
- Adjust for width desired.
- For straight edges, align guide with the presser foot.
- For curved edges, set the guide at an angle so that the end closest to the needle acts as a guide.

- For pinned seams, place the pins with the points toward the seam edge so that they nip into the fabric at the stitching line. The hinged foot will then ride freely over the points.

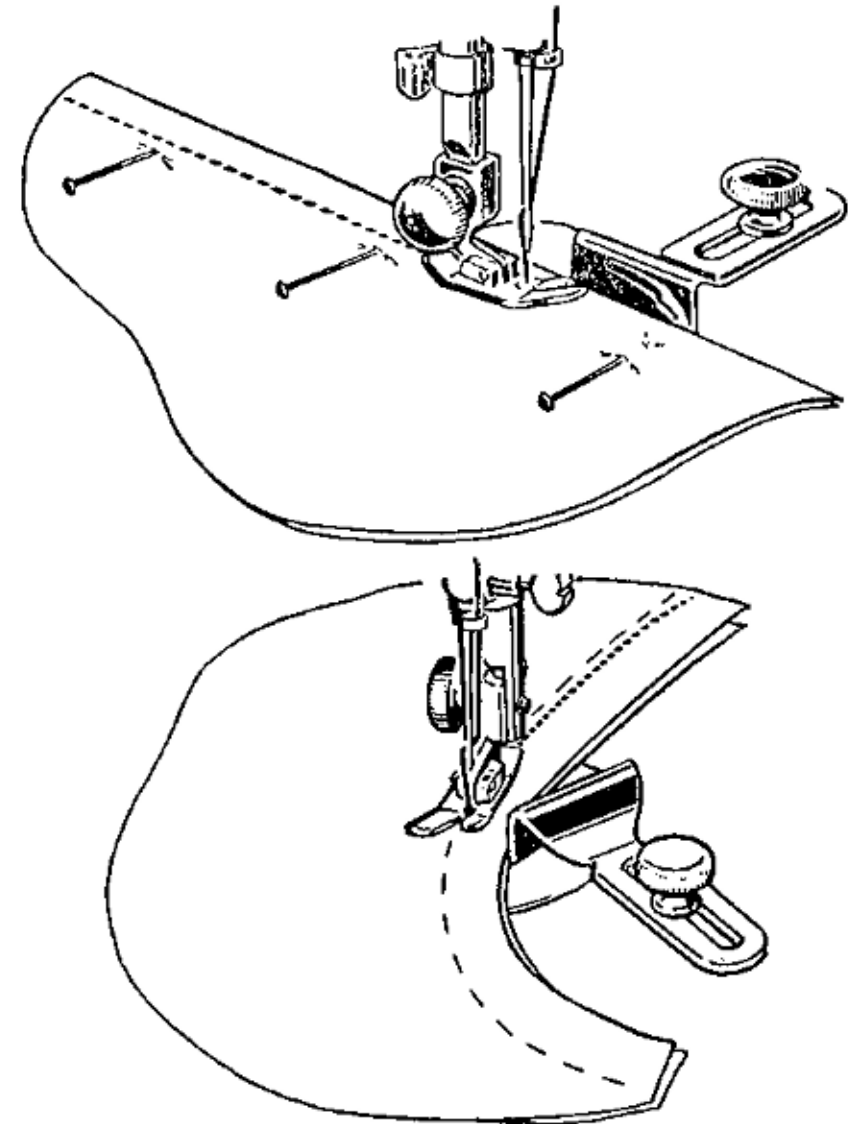

THE ZIPPER FOOT

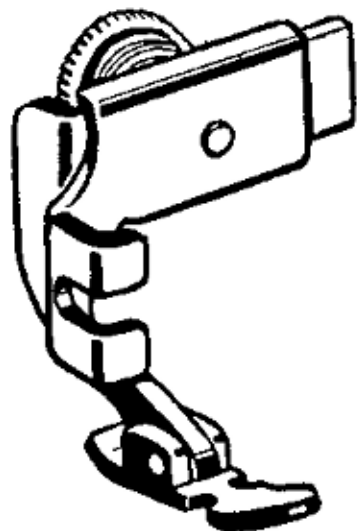

The zipper foot is designed for accurate placement of stitches close to a raised edge. The hinged feature of this foot insures even feeding over pins, heavy layers of fabric or cross seams. It is attached to the machine in place of the presser foot, and may be adjusted to either side of the needle.

Applications

Zipper insertions
Corded seams

Tubular cording
Slip cover welting

Preparation

- Attach zipper foot to machine in place of presser foot.
- Loosen zipper foot thumb screw and adjust foot to right or left of needle, as desired.
- Align the notch in the toe with the needle hole in the throat plate.
- Check adjustment by lowering needle into side notch, making sure it clears the foot.
- Lock foot in position by tightening thumb screw.

Skirt Zipper

- Machine baste placket opening of skirt and press this seam open.
- Attach zipper foot to machine in place of presser foot.
- Position zipper foot to right of needle.
- Open zipper.
- Place zipper face down on seam allowance with edge of teeth at seam line.
- Turn the back seam allowance away from body of skirt.
- Stitch zipper tape to the seam allowance.

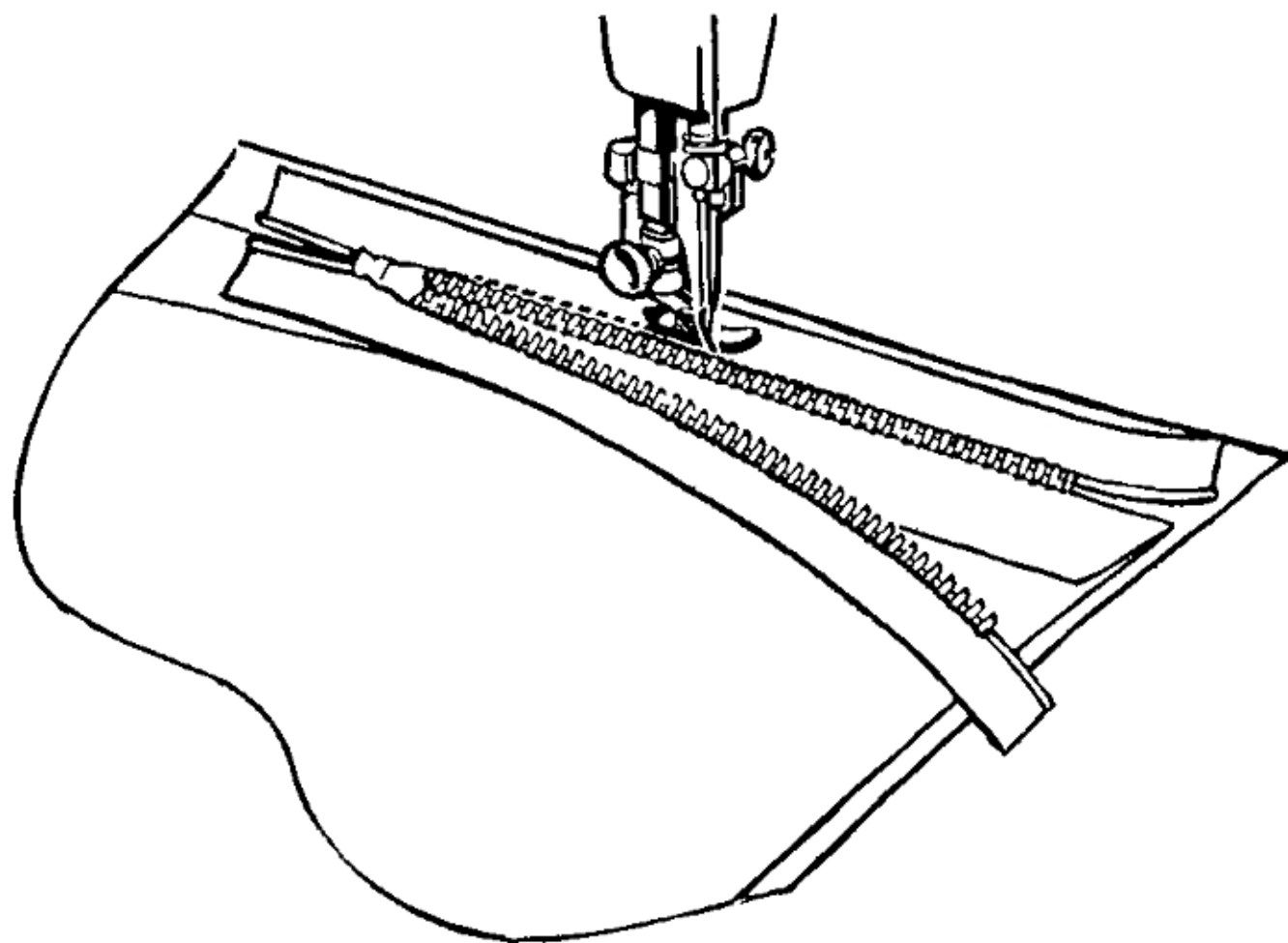

- Move foot to the left of needle.
- Close zipper and turn it face up.
- Smooth back the seam allowance at the edge of the zipper.
- Top stitch the seam allowance to the tape close to the folded edge.

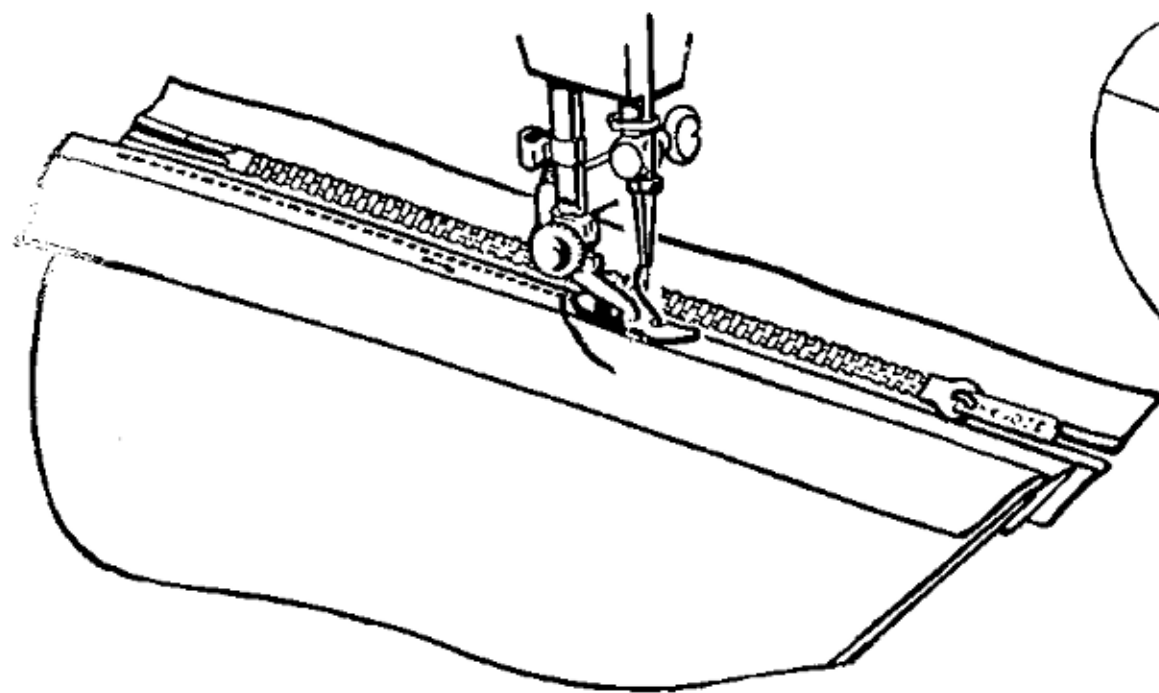

- Turn skirt to right side.
- Fold zipper to front of skirt.
- Pin in place from right side.
- Baste.
- Move foot to right of needle.
- Stitch across lower end of zipper and up to waistline.
- Remove basting.

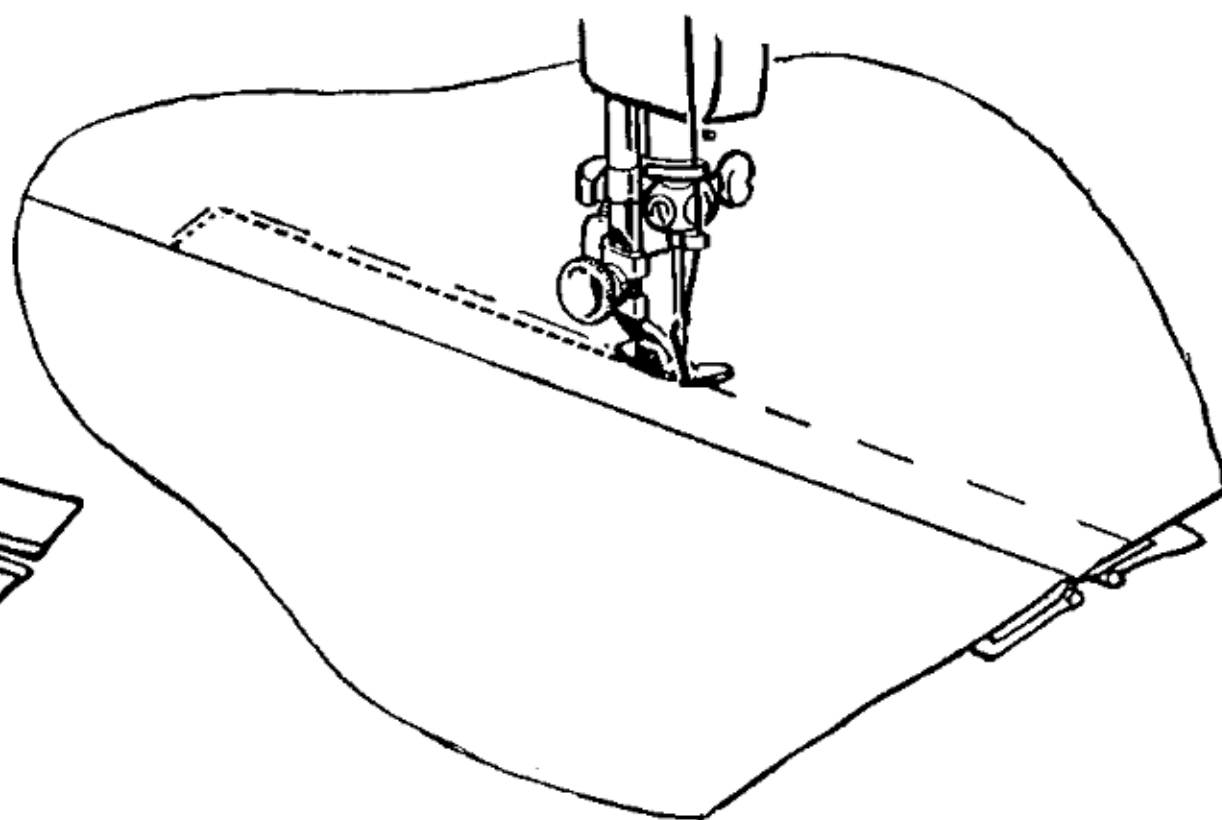

Corded Welting

Cable cord comes in a variety of sizes and when covered with a firmly woven fabric makes a corded welting that is an excellent seam finish.

This welting is prepared in advance and then stitched into the seam. Cut a true bias strip $1\frac{1}{4}$ inches wide, plus three times the width of the cord of either self or contrasting fabric. Sew strips together on the lengthwise grain to obtain desired length.

- Adjust zipper foot to left side of needle.
- Encase cord in bias strip, raw edges even.
- Lower presser bar.
- Stitch close to cord, using a stitch length slightly longer than for plain seaming of same fabric.
- Do not crowd stitching against cord.

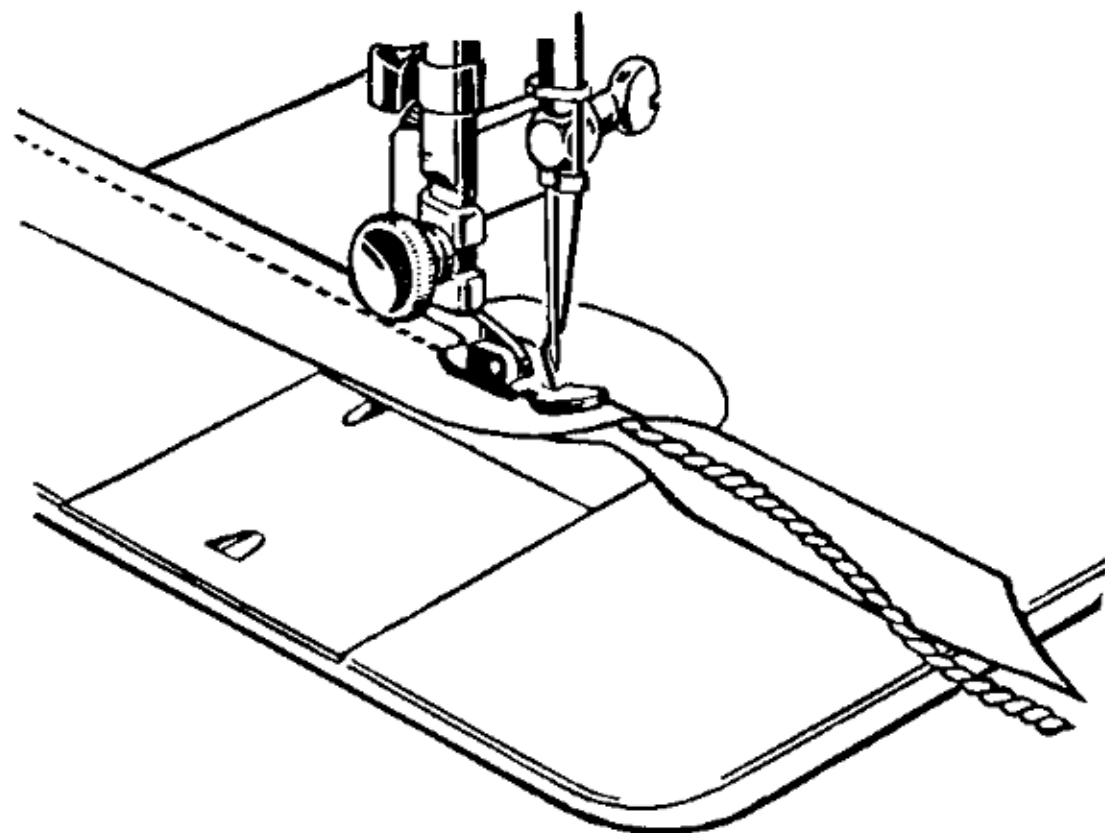
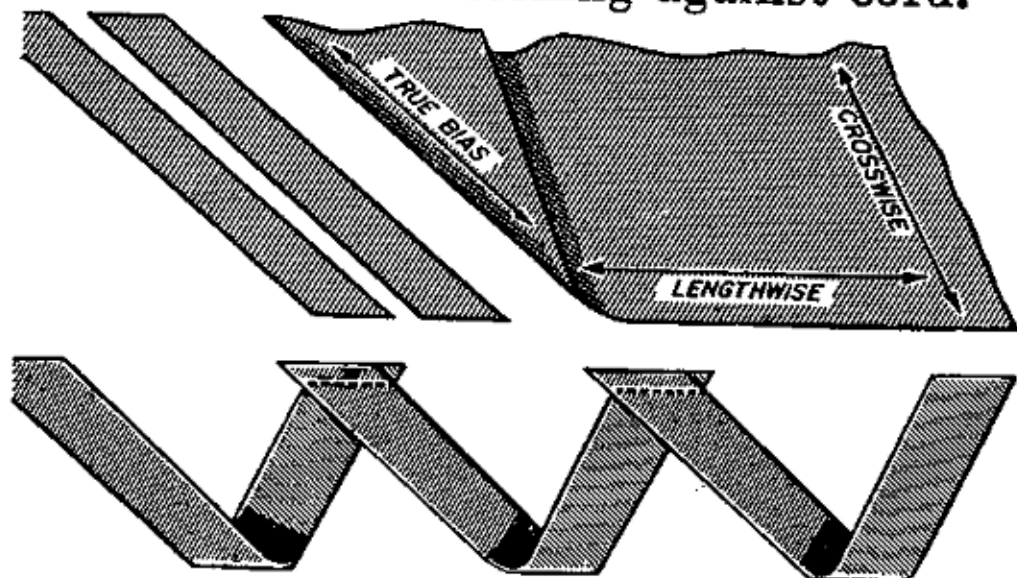

Corded Seams

The corded seam is a typical treatment for slip covers, children's clothes, blouses and lingerie.

When cording a seam the zipper foot is usually adjusted to the right of the needle so that the bulk of the work will fall to the left.

- Attach corded welting to right side of a single seam edge, using same length stitch as used for welting (page 40). Guide edge of foot next to cord, but do not crowd.

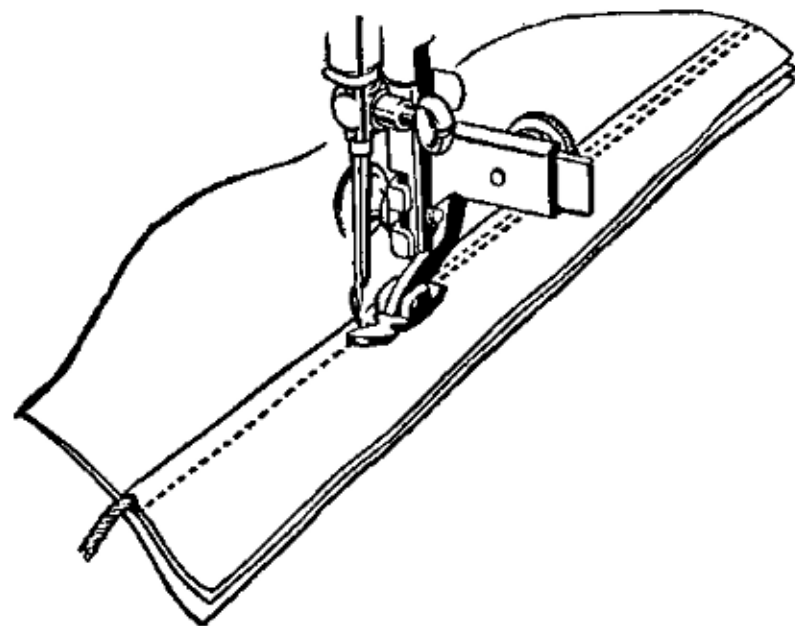

D

- Place attached corded welting over second seam edge, and pin or baste together.
- Keep the first stitching uppermost as a guide and position the seam under the needle.
- Stitch, this time crowding the foot against the cord.

This method produces evenly joined seam edges and tightly set welting.

Curved seams are corded as easily as straight seams, except that a shorter stitch is used. Since the seam allowance of the welting is bias, it is easy to shape it to the seam.

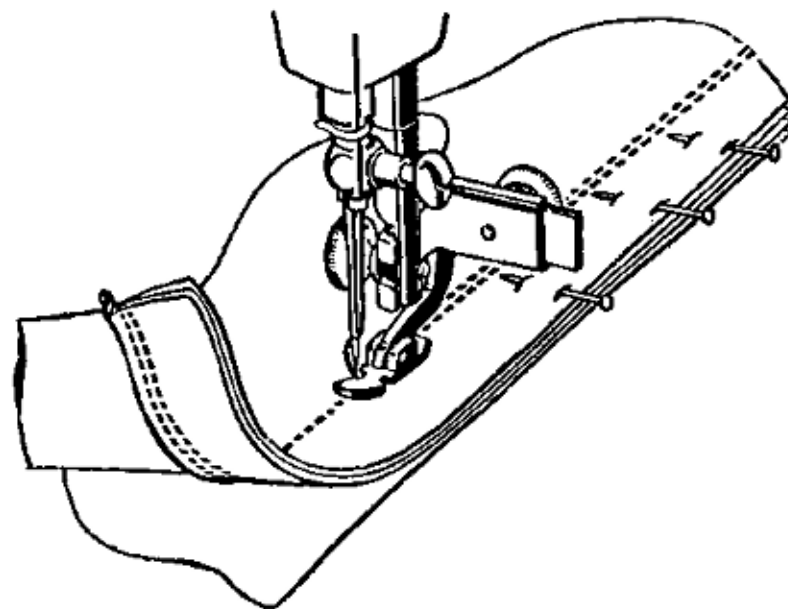

49

FASHION AIDS

available for separate purchase at your local SINGER SEWING CENTRE.

THE BUTTONHOLER

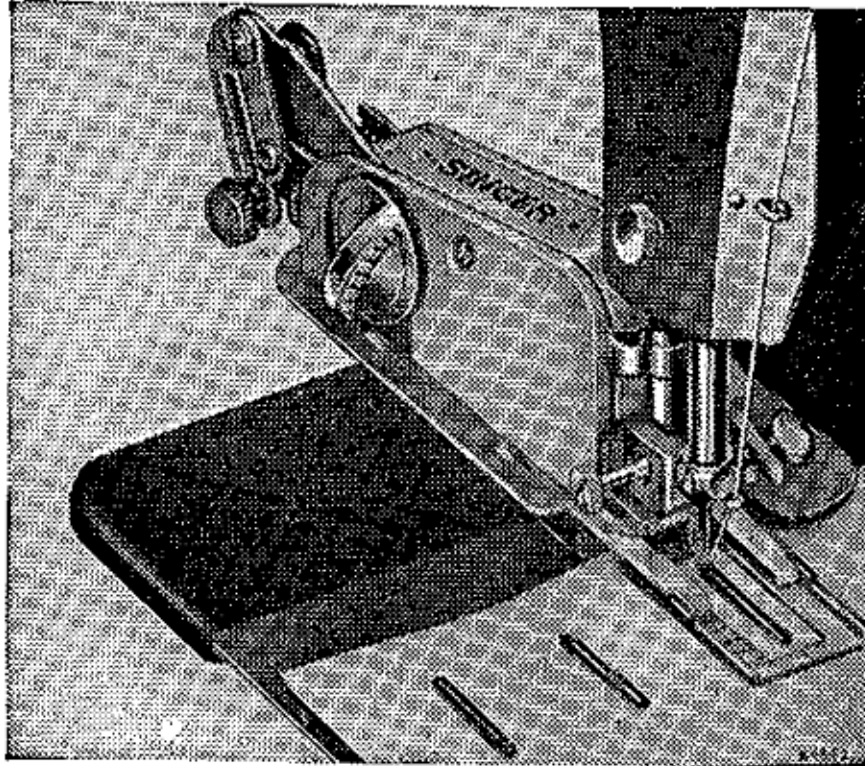

This attachment produces neat and durable buttonholes in a great variety of fabrics without any special skill on the part of the operator. The buttonholes are produced in a fraction of the time required for hand work and they are firmer and more even than those made by hand.

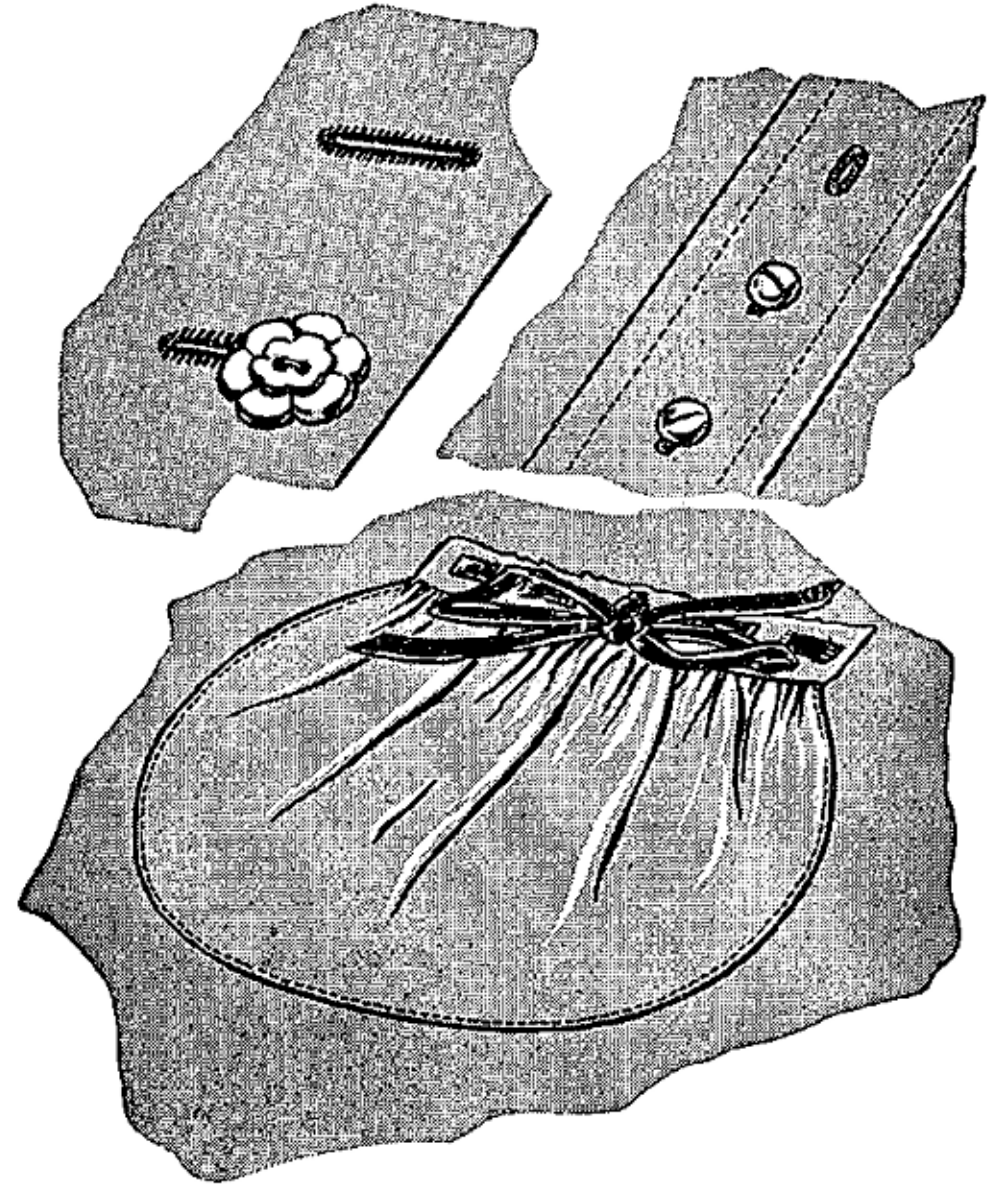

THE BLIND STITCHER

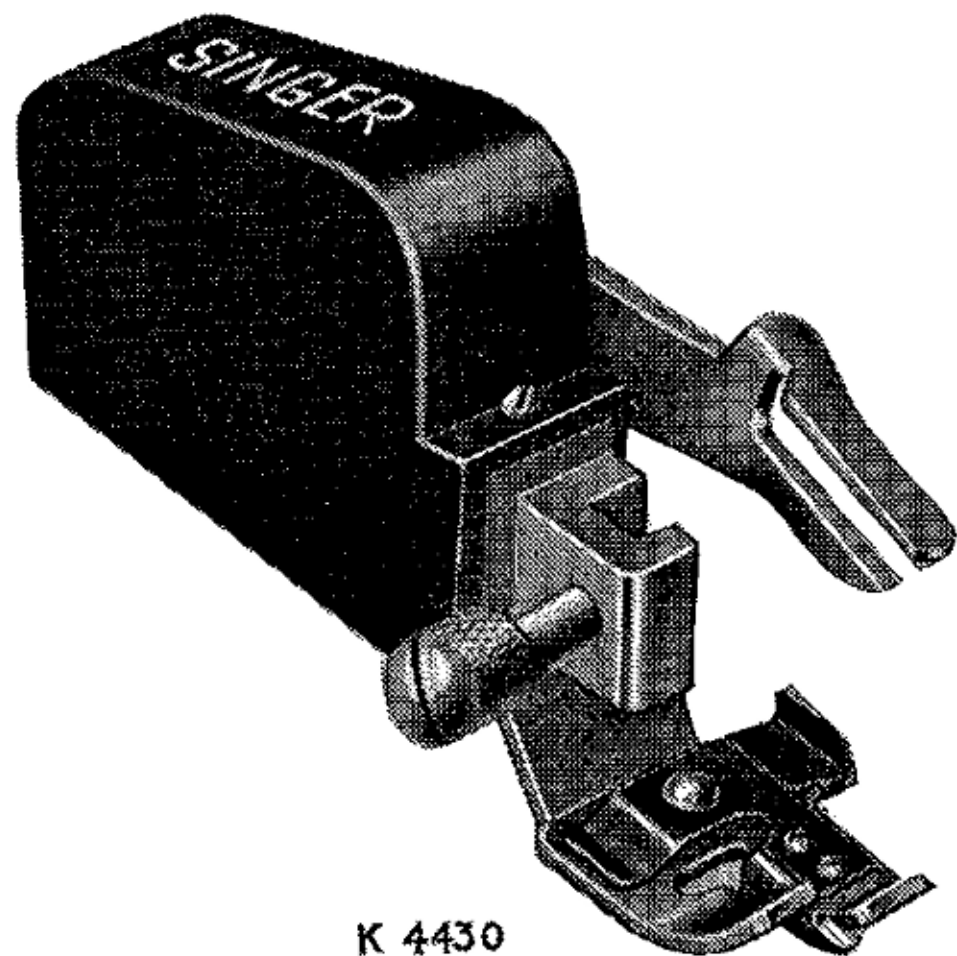

This useful **SINGER** attachment produces invisible hemming with perfect blind stitches on an almost unlimited variety of work such as skirts, dresses, lingerie, children's clothes, towels, curtains, sheets, table cloths and many other articles.

It is quickly attached to your sewing machine in place of the presser foot. It is easy to use and will enable you to accomplish superior invisible hemming much faster and with less effort than is possible by hand.

THE ZIGZAGGER

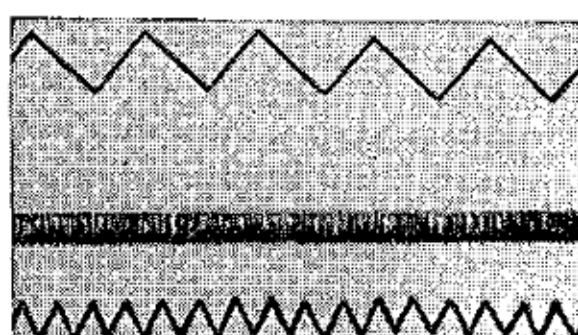
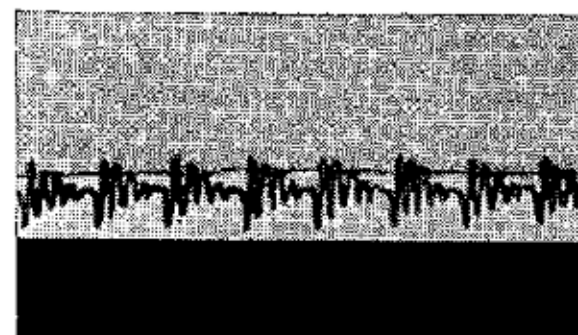
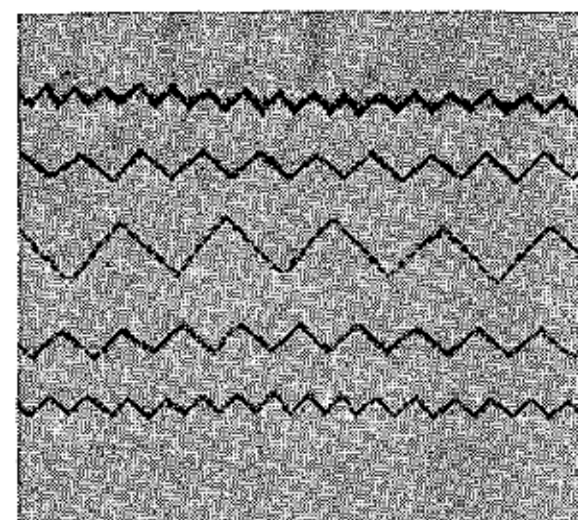
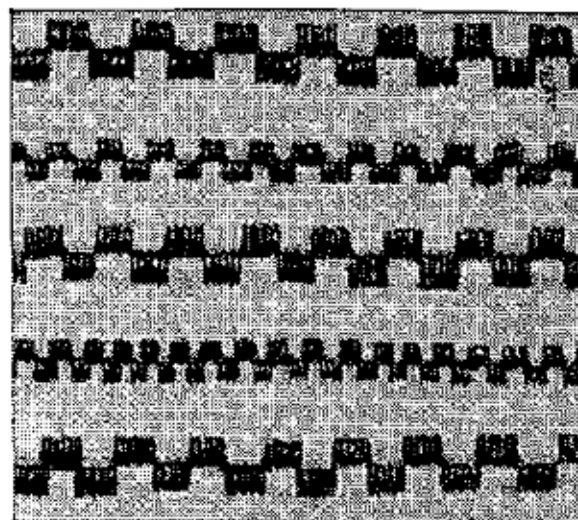
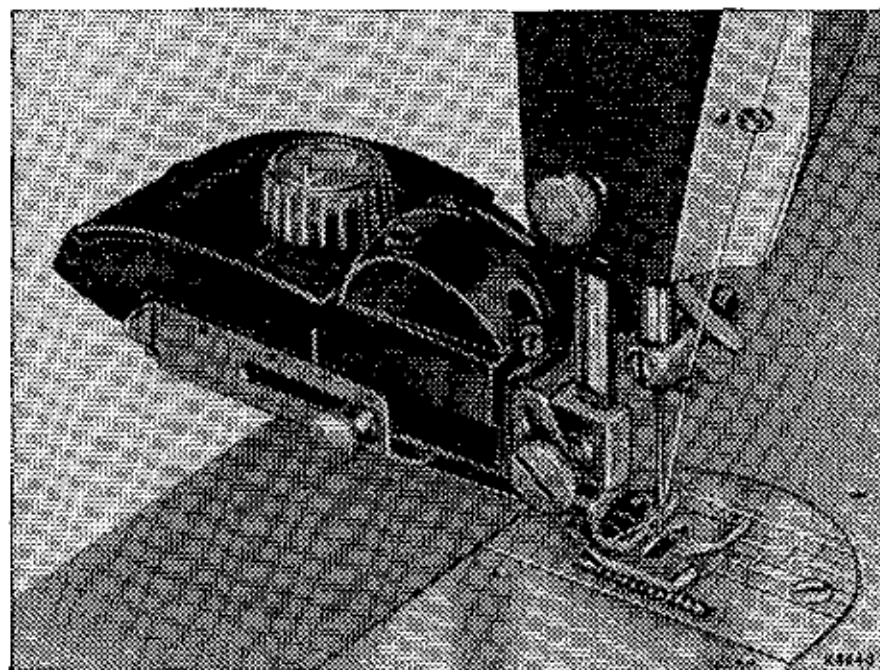

Some of the designs made by SINGER Zigzagger

This wonderful SINGER fashion aid will enable you to produce an infinite variety of attractive ornamental designs merely through the interchange of the different Stitch Patterns and the adjustment of the bight and stitch length. Such decorative effects as applique, scalloped edges, border designs, as well as blind stitched hems and simple mending can be produced with this attachment on women's and children's clothing, lingerie, linens, draperies and an unlimited array of other garments and household items.

With the flick of a lever, plain sewing may be done without removing the zigzagger from the sewing machine.

THE BIAS GAUGE

The Bias Gauge is very useful (especially in the case of soft materials) when cutting bias strips from $\frac{7}{16}$ inch to $1\frac{3}{8}$ inches in width. This is done by placing the bias gauge upon the point of the scissors and setting the blued indicator to the width desired. The line **F** is the point at which to set the blued indicator for facings, the line **B** for binding, and the line **C** for cording or piping.

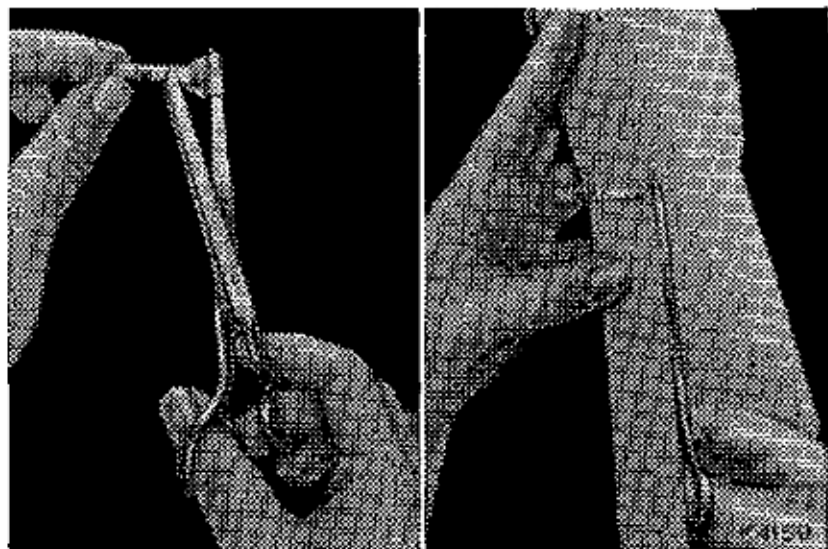

Insert the material in the gauge with the edge against the blued indicator, and hold as shown above.

Bias binding should be cut $\frac{15}{16}$ inch wide, and to do this the indicator should be set midway between the lines **F** and **B**.

THE EDGE-STITCHER

The edge stitcher provides a series of slotted guides which regulate the placement of stitches in relation to a fabric edge.

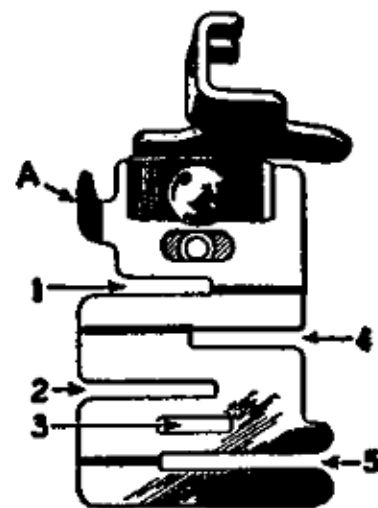

It is attached to the machine in place of the presser foot.

Applications

Joining lace and insertion. French seams. Tucking with lace. Straight and pin tucks. Facing and seam finishes. Seam piping.

Joining Lace and Insertion

Lovely lingerie detail is simple to accomplish with the edge stitcher by joining lace insertion or alternate bands of fabric and lace. Slots 1 and 4 are used for this work. Since slot 1 overlaps slot 4, the edge inserted into slot 1 will be the top stitched edge.

- Place the first band (the fabric band where used) into slot 1.

- Adjust lug A to position the stitching close to the edge of this band.
- Place the second band (lace) into slot 4.
- Adjust pressure to correct degree of lightness for even feeding.
- Use a short stitch length and balanced tensions.
- Hold both band edges against the ends of the slots while stitching.

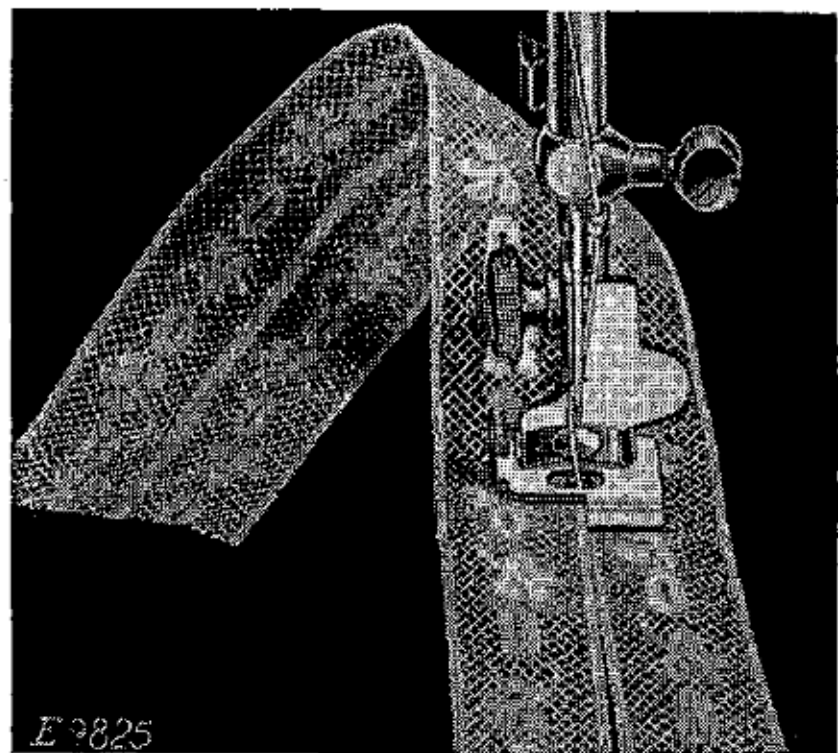

French Seams

The edge stitcher makes very fine French seams, so well adapted to sheer fabrics where raw seam edges must be concealed.

- Trim away seam allowances to $\frac{1}{4}$ ".
- Lay seam edges together, right sides of fabric outward, and insert into slot 1.
- Move lug A to the left to position stitching $\frac{1}{8}$ " from the edge.
- Stitch and press.
- Fold with right sides of fabric together and insert into slot 1.
- Move lug A to extreme left, allowing just enough margin to conceal raw edges.
- Stitch.

Tucking

Dainty tucks from "pin" width to $\frac{1}{4}$ " may be produced with the edge stitcher. Tucks are usually made on the lengthwise grain of the fabric.

- Draw a single thread from the fabric, or measure from the selvage to locate the first tuck on the straight grain of the fabric.

- For succeeding tucks, crease fabric or draw a thread at distance desired from previous tuck.
- Press tuck folds before stitching.
- To make "pin" tucks, insert the tuck fold in slot 1 and adjust lug A to locate stitching a pin width from the fold.
- To make $\frac{1}{4}$ " tucks, insert the tuck fold into slot 5, and move lug A to its extreme left position.

Use a short stitch length and perfectly balanced tensions.

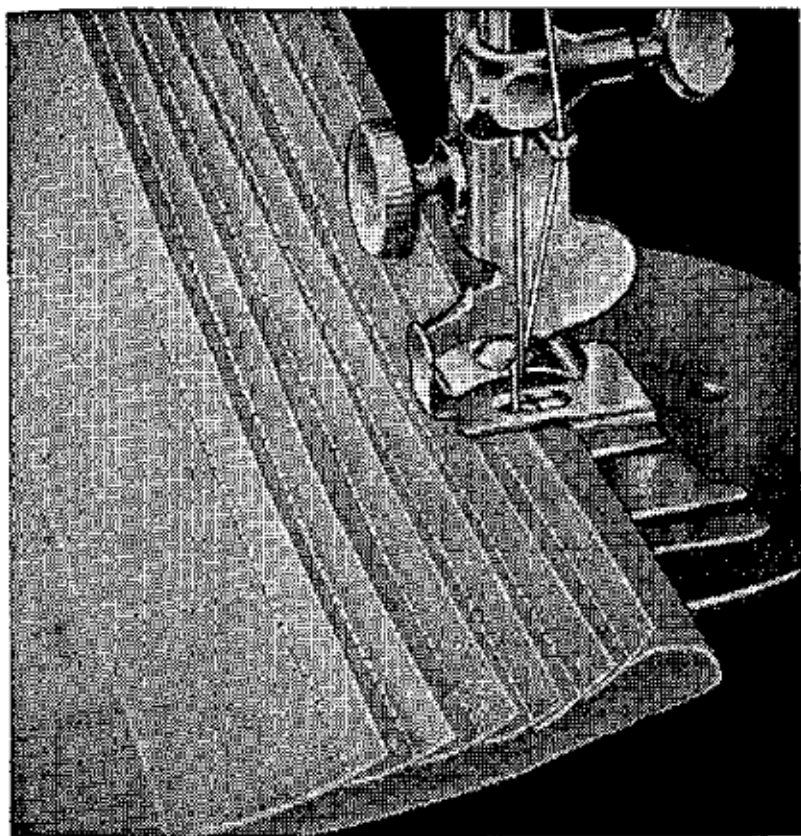

THE QUILTER

The Quilter, designed with a short, open foot and an adjustable and removable space guide, is especially well adapted to stitching lightly padded materials. The light padding is basted to the underside of the fabric and may be of outing flannel, canton flannel, sheet wadding or light wool interlining.

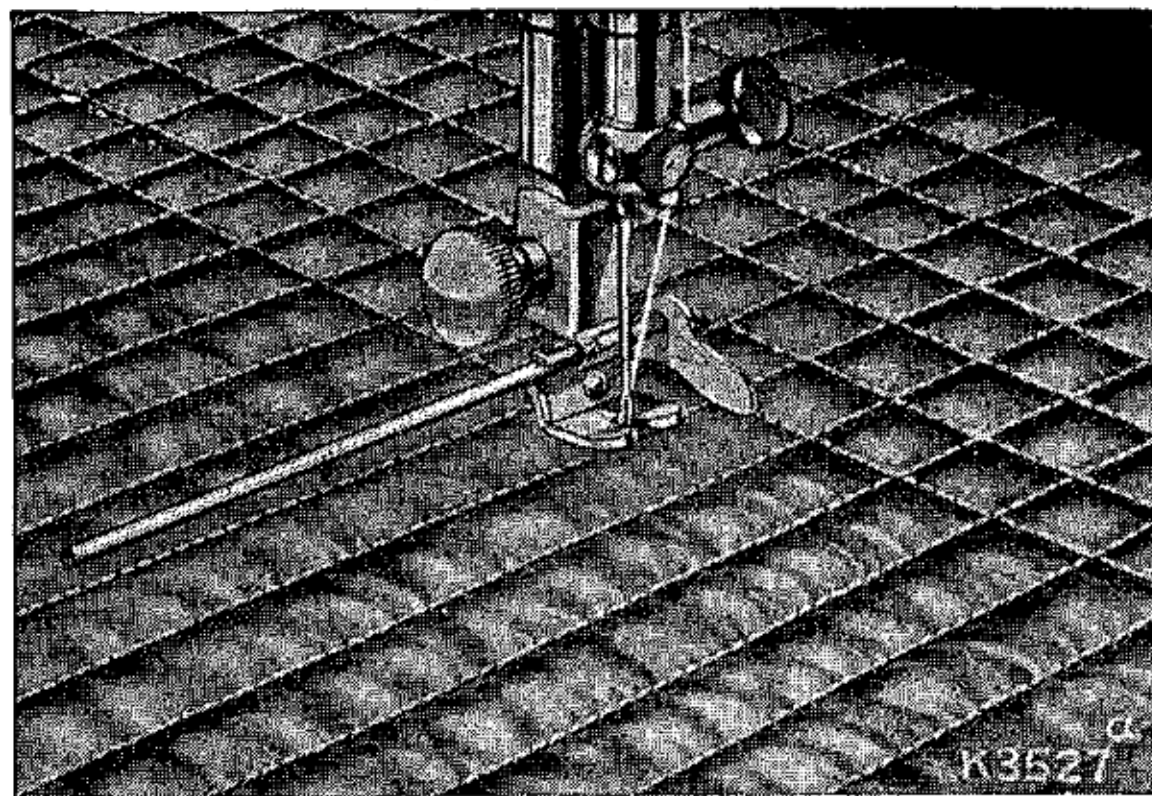

Replace the presser foot with the Quilter. Adjust the space guide for the width between stitching lines. The space guide may be used to the right or left of the needle.

THE ADJUSTABLE HEMMER

To Make Hems from 3/16 to 15/16 Inch Wide

1. Attach adjustable hemmer to presser bar in place of presser foot.
2. Pull up bobbin thread as instructed on page 19.
3. Loosen thumb screw on hemmer and move scale until pointer registers with number of desired width of hem. (No. 1 indicates the narrowest hem and No. 8, the widest.) Then tighten thumb screw.
4. Place cloth in hemmer and draw it back and forth until hem is formed as shown.
5. Draw end of hem back under needle, lower presser bar and start to sew.
6. Guide sufficient cloth into hemmer to turn hem properly.

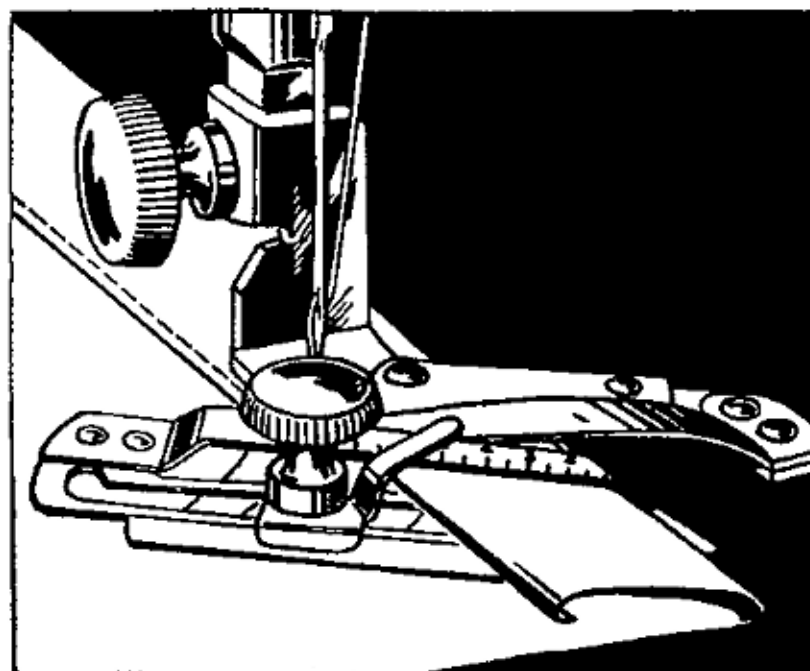

THE ADJUSTABLE HEMMER

WIDE HEMMING

To make a hem more than $\frac{1}{8}$ inch wide, loosen thumb screw in hemmer and move scale to right as far as it will go, then swing it toward you as shown and tighten thumb screw. Fold and crease down a hem of the desired width, pass fold under extension at right of hemmer, and the edge into folder as shown and proceed to stitch the hem.

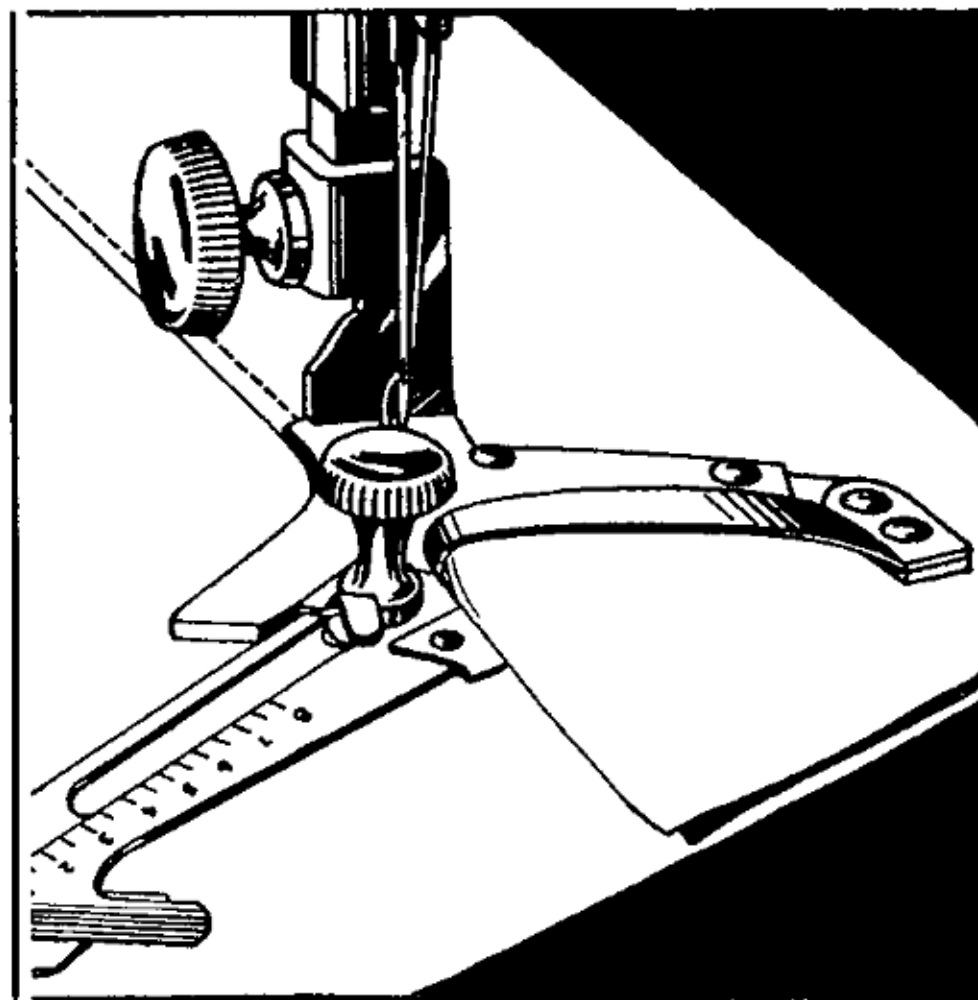

THE TUCKER

The Tucker is a time-saver for making tucks up to one inch in width. Two adjustable scales are provided, the smaller near the needle is numbered from 1 to 8, expressing in eighths of an inch the width of the tuck. The larger scale expresses in quarter inches the spacing between tucks.

Set the tuck scale first for the width of tuck. The space scale is then adjusted using the needle as an indicator for the spacing between tucks. When both scales are set at the same number, blind tucks result. That is, the fold of one tuck just touches the stitching line of the next. When additional space between tucks is desired, adjust the space scale to a point beyond the tuck scale reading equal to the spacing desired, expressed in quarters of an inch. Thus half-inch tucks spaced a half inch apart require a tuck scale setting of 4, and a space scale setting of 6.

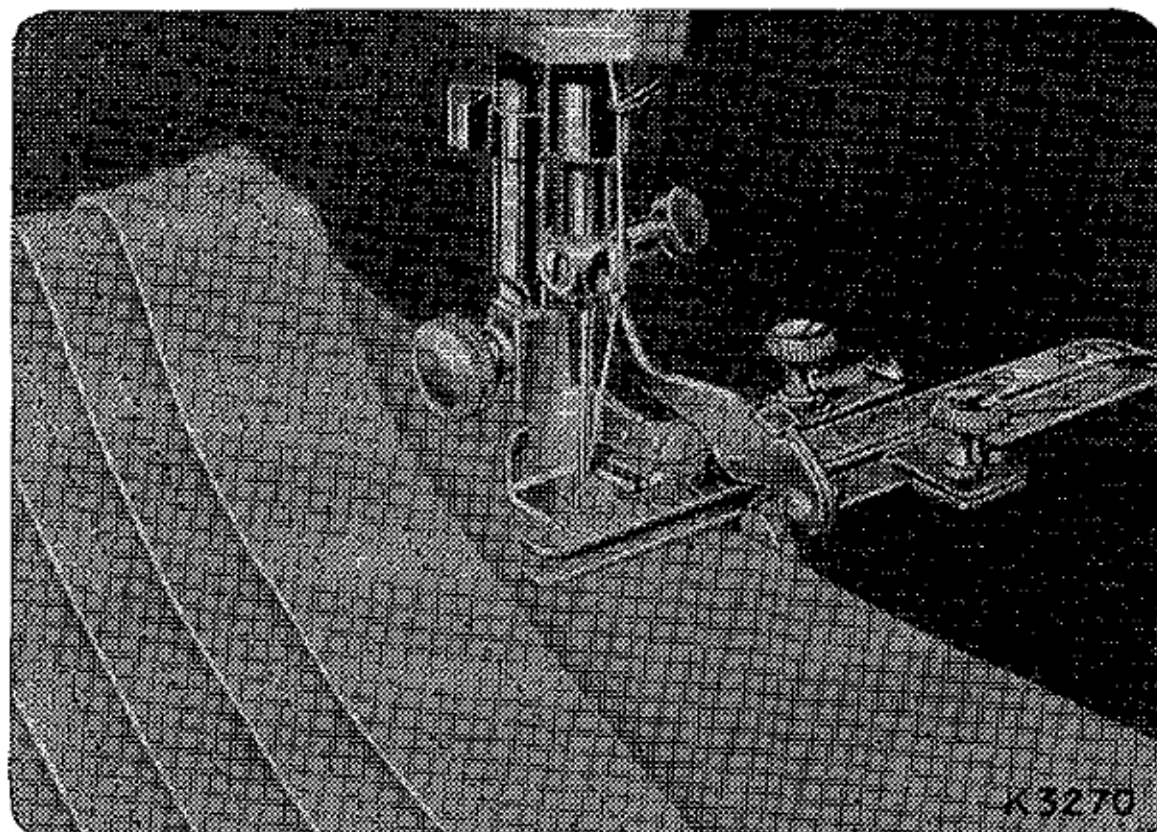

INDEX

	Page		Page
Attachments	33	Fashion Aids	50
Binder	37	Bias Gauge	53
Foot Hemmer.....	34	Blind Stitcher.....	51
Gathering Foot	40	Buttonholer	50
Ruffler	41	Edge Stitcher	53
Seam Guide	44	Hemmer, Adjustable	56
Zipper Foot	45	Quilter	55
Belt Shifter	9	Tucker	58
Bobbin		Zigzagger, Automatic	52
Removing	13	Hand Attachment	8
Replacing	15	Light	5
Winding	13	Lubrication	
Bobbin Case		To Oil the Machine and Stand	27
Removing	30	To Oil the Sewing Hook	28
Replacing	31	Needles and Thread	11
Threading	15	Needle Setting	10
Bobbin Winder	13	Presser Foot, to Regulate Pressure	21
Darning and Embroidery	24	Rust damage, prevention of	26
Electrical Information	4	Service, SINGER	3

INDEX—continued.

	Page		Page
Sewing		Stitch Forming Mechanism	
To Operate Electric Machine	7	Cleaning	30
To Operate Hand Machine	8	Stop Motion	9
To Operate Treadle Machine	9	Threading	
To Prepare for Sewing	17	Upper Threading	12
To Start Sewing	18	Bobbin Case Threading	15
To Turn a Corner	19	Thread Tensions	21
Basting	19	Bobbin Thread Tension,	
To Sew Bias Seams	19	to Regulate	23
To Remove the Work	20	Needle Thread Tension,	
To Regulate Length of Stitch and		to Regulate	22
Direction of Feed	20		
Sewing Suggestions	25		

For your protection

SINGER Sewing Machines are sold and serviced wherever you see the famous SINGER and Red "S" Trademarks. When your machine needs servicing call your SINGER SEWING CENTRE to be sure of warranted SINGER parts and service. See address in the classified telephone directory.

S I N G E R S E W I N G M A C H I N E C O M P A N Y